

MS2665C/67C/68C  
Spectrum Analyzer  
Operation Manual  
Vol. 2  
(Detailed Operating Instructions)

Seventh Edition

**Read this manual before using the equipment.  
Keep this manual with the equipment.**

**ANRITSU CORPORATION**

OCT.  
2003

Document No.: M-W1335AE-7.0

# Safety Symbols

To prevent the risk of personal injury or loss related to equipment malfunction, Anritsu Corporation uses the following safety symbols to indicate safety-related information. Insure that you clearly understand the meanings of the symbols BEFORE using the equipment.

## Symbols used in manual

**DANGER** 

This indicates a very dangerous procedure that could result in serious injury or death if not performed properly.

**WARNING** 

This indicates a hazardous procedure that could result in serious injury or death if not performed properly.

**CAUTION** 

This indicates a hazardous procedure or danger that could result in light-to-severe injury, or loss related to equipment malfunction, if proper precautions are not taken.

## Safety Symbols Used on Equipment and in Manual

(Some or all of the following five symbols may not be used on all Anritsu equipment. In addition, there may be other labels attached to products which are not shown in the diagrams in this manual.)

The following safety symbols are used inside or on the equipment near operation locations to provide information about safety items and operation precautions. Insure that you clearly understand the meanings of the symbols and take the necessary precautions BEFORE using the equipment.



This indicates a prohibited operation. The prohibited operation is indicated symbolically in or near the barred circle.



This indicates an obligatory safety precaution. The obligatory operation is indicated symbolically in or near the circle.



This indicates warning or caution. The contents are indicated symbolically in or near the triangle.



This indicates a note. The contents are described in the box.



These indicate that the marked part should be recycled.

MS2665C/67C/68C Spectrum Analyzer

Operation Manual Vol. 2 (Detailed Operating Instructions)

28 November 1997 (First Edition)

9 May 2003 (Seventh Edition)

Copyright © 1997-2003, ANRITSU CORPORATION.

All rights reserved. No part of this manual may be reproduced without the prior written permission of the publisher.

The contents of this manual may be changed without prior notice.

Printed in Japan

## For Safety

### WARNING



1. ALWAYS refer to the operation manual when working near locations at which the alert mark shown on the left is attached. If the operation, etc., is performed without heeding the advice in the operation manual, there is a risk of personal injury. In addition, the equipment performance may be reduced. Moreover, this alert mark is sometimes used with other marks and descriptions indicating other dangers.



2. When supplying power to this equipment, connect the accessory 3-pin power cord to a 3-pin grounded power outlet. If a grounded 3-pin outlet is not available, before supplying power to the equipment, use a conversion adapter and ground the green wire, or connect the frame ground on the rear panel of the equipment to ground. If power is supplied without grounding the equipment, there is a risk of receiving a severe or fatal electric shock.

Repair

**WARNING** 

3. This equipment cannot be repaired by the user. DO NOT attempt to open the cabinet or to disassemble internal parts. Only Anritsu-trained service personnel or staff from your sales representative with a knowledge of electrical fire and shock hazards should service this equipment. There are high-voltage parts in this equipment presenting a risk of severe injury or fatal electric shock to untrained personnel. In addition, there is a risk of damage to precision parts.

Falling Over

4. This equipment should be used in the correct position. If the cabinet is turned on its side, etc., it will be unstable and may be damaged if it falls over as a result of receiving a slight mechanical shock.

## For Safety

### WARNING

#### LCD

5. This instrument uses a Liquid Crystal Display (LCD); DO NOT subject the instrument to excessive force or drop it. If the LCD is subjected to strong mechanical shock, it may break and liquid may leak.

This liquid is very caustic and poisonous.

DO NOT touch it, ingest it, or get in your eyes. If it is ingested accidentally, spit it out immediately, rinse your mouth with water and seek medical help. If it enters your eyes accidentally, do not rub your eyes, irrigate them with clean running water and seek medical help. If the liquid gets on your skin or clothes, wash it off carefully and thoroughly.

#### Battery fluid

6. DO NOT short the battery terminals and never attempt to disassemble it or dispose of it in a fire. If the battery is damaged by any of these actions, the battery fluid may leak.

This fluid is poisonous.

DO NOT touch it, ingest it, or get in your eyes. If it is accidentally ingested, spit it out immediately, rinse your mouth with water and seek medical help. If it enters your eyes accidentally, do not rub your eyes, irrigate them with clean running water and seek medical help. If the liquid gets on your skin or clothes, wash it off carefully and thoroughly.

## For Safety

### CAUTION

---

#### Changing Fuse

#### CAUTION

1. Before changing the fuses, ALWAYS remove the power cord from the power outlet and replace the blown fuses. ALWAYS use new fuses of the type and rating specified on the fuse marking on the rear panel of the cabinet.

T5A indicates a time-lag fuse.

There is risk of receiving a fatal electric shock if the fuses are replaced with the power cord connected.

#### Cleaning

2. Keep the power supply and cooling fan free of dust.
  - Clean the power inlet regularly. If dust accumulates around the power pins, there is a risk of fire.
  - Keep the cooling fan clean so that the ventilation holes are not obstructed. If the ventilation is obstructed, the cabinet may over-heat and catch fire.

#### Input Level



3.
    - Maximum DC voltage ratings:  
RF Input      DC 0 V
    - Maximum AC power ratings:  
RF Input      +30 dBm
    - NEVER input a >+30 dBm and >DC 0 V power to RF Input.
    - Excessive power may damage the internal circuits.
-

## For Safety

### CAUTION

---

#### Replacing Memory Back-up Battery

4. The power for memory back-up is supplied by a Polycarbonmonofluoride Lithium Battery. This battery should only be replaced by a battery of the same type; since replacement can only be made by Anritsu, contact the nearest Anritsu representative when replacement is required.

*Note: The Battery life is about 7 years. Early battery replacement is recommended.*

#### Storage Medium

5. This equipment stores data and programs using Plug-in Memory card (MC).  
Data and programs may be lost due to improper use or failure.  
ANRITSU therefore recommends that you back-up the memory.

ANRITSU CANNOT COMPENSATE FOR ANY MEMORY LOSS.

Please pay careful attention to the following points.

- Do not remove the IC card from equipment being accessed.
- Isolate the card from static electricity.
- The back-up battery in the SRAM memory card has a limited life; replace the battery periodically.

#### Disposing of The Product

6. This equipment uses chemical compound semiconductor including arsenide.  
At the end of its life, the equipment should be recycled or disposed properly according to the local disposal regulations.
-

# Equipment Certificate

Anritsu Corporation certifies that this equipment was tested before shipment using calibrated measuring instruments with direct traceability to public testing organizations recognized by national research laboratories including the Electrotechnical Laboratory, the National Research Laboratory of Metrology and the Communications Research laboratory, and was found to meet the published specifications.

## Anritsu Warranty

Anritsu Corporation will repair this equipment free-of-charge if a malfunction occurs within 1 year after shipment due to a manufacturing fault, provided that this warranty is rendered void under any or all of the following conditions.

- The fault is outside the scope of the warranty conditions described in the operation manual.
- The fault is due to misoperation, misuse, or unauthorized modification or repair of the equipment by the customer.
- The fault is due to severe usage clearly exceeding normal usage.
- The fault is due to improper or insufficient maintenance by the customer.
- The fault is due to natural disaster including fire, flooding and earthquake, etc.
- The fault is due to use of non-specified peripheral equipment, peripheral parts, consumables, etc.
- The fault is due to use of a non-specified power supply or in a non-specified installation location.

In addition, this warranty is valid only for the original equipment purchaser. It is not transferable if the equipment is resold.

Anritsu Corporation will not accept liability for equipment faults due to unforeseen and unusual circumstances, nor for faults due to mishandling by the customer.

## Anritsu Corporation Contact

If this equipment develops a fault, contact the head office of Anritsu Corporation at the address in the operation manual, or your nearest sales or service office listed on the following pages.

## Notes On Export Management

---

This product and its manuals may require an Export License/Approval by the Government of the product's country of origin for re-export from your country.

Before re-exporting the product or manuals, please contact us to confirm whether they are export-controlled items or not.

When you dispose of export-controlled items, the products/manuals are needed to be broken/shredded so as not to be unlawfully used for military purpose.



---

## Front Panel Power Switch

---

To prevent malfunction caused by accidental touching, the front power switch of this equipment turns on the power if it is pressed continuously for about one second in the standby state. If the switch is pressed continuously for one second in the power-on state, the equipment enters the standby state.

In the power-on state, if the power plug is removed from the outlet, then reinserted into it, the power will not be turned on. Also, if the lines is disconnected due to momentary power supply interruption or power failure, the power will not be turned on (enters the standby state) even if the line is recovered.

This is because this equipment enters the standby state and prevents incorrect data from being acquired when the line has to be disconnected and reconnected.

For example, if the sweep time is 1,000 seconds and data acquisition requires a long time, momentary power supply interruption (power failure) might occur during measurement and the line could be recovered automatically to power-on. In such a case, the equipment may mistake incorrect data for correct data without recognizing the momentary power supply interruption.

If this equipment enters the standby state due to momentary power supply interruption or power failure, check the state of the measuring system and press the front power switch to restore power to this equipment.

Further, if this equipment is built into a system and the system power has to be disconnected then reconnected, the power for this equipment must also be restored by pressing the front power switch.

Consequently, if this equipment is built into remote monitoring systems that use MODEMs, the standby function of this equipment must be modified.

-----

## ABOUT DETECTION MODE

-----

This instrument is a spectrum analyzer which uses a digital storage system. The spectrum analyzer makes level measurements in frequency steps obtained by dividing the frequency span by the number of measurement data points (501). This method of measurement cannot detect the signal peak level if the spectrum of a received signal is narrower than these frequency steps.

To resolve this problem, this instrument usually operates in positive peak detection mode and normal detection mode. In the positive peak detection mode, the highest level within the frequency range between the sample points can be held and traced. In the normal detection mode, both the positive peak and the negative peak can be traced.

Positive peak detection mode should be used for almost all measurements including normal signal level measurement, pulsed noise analysis, and others. It is impossible to measure the signal level accurately in sample detection mode or in negative peak detection mode.

Use of sample detection mode is restricted to random noise measurement, occupied frequency bandwidth measurement for analog communication systems, and adjacent-channel leakage power measurement, etc.

Measurement	item
• Normal signal .....	POS PEAK
• Random noise .....	SAMPLE
• Pulsed noise .....	NORMAL (POSI-NEG)
• Occupied frequency bandwidth, adjacent-channel leakage power .....	SAMPLE
(for analog communication systems)	
• Occupied frequency bandwidth, adjacent-channel leakage power .....	POS PEAK or SAMPLE
(for digital communication systems)	

When a detection mode is specified as one of the measurement methods, make the measurement in the specified detection mode.

## ABOUT THIS MANUAL

### (1) Composition of MS2665C/67C/68C spectrum analyzer Operation Manuals

The MS2665C/67C/68C Spectrum Analyzer operation manuals of the standard type are composed of the following three documents. Use them properly according to the usage purpose.

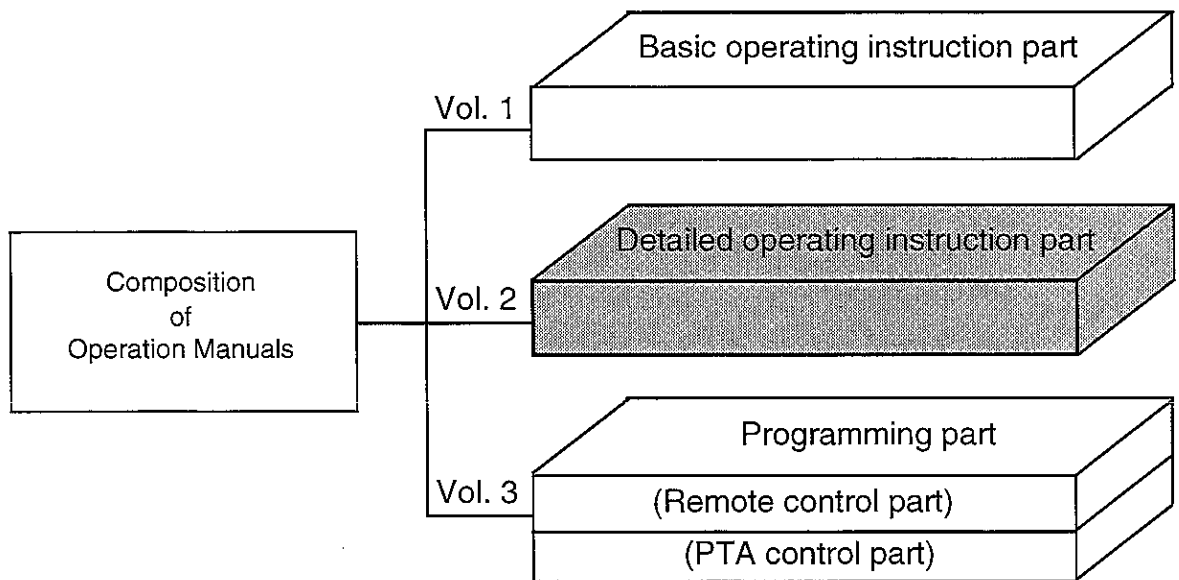

Basic operating instruction part:

Basic Operating Instructions: Provides information on the MS2665C/67C/68C outline, preparation before use, panel description, basic operation, soft-key menu and performance tests.

Detailed operating instruction part:

Detailed Operating Instructions: Provides information on the detailed panel operating instructions on the spectrum analyzer that expand on the basic operation and softkey menu in the Basic Operating Instruction Part.

Programming part:

Composed of the Remote Control Part and PTA Control Part. The Remote Control Part provides information on RS-232C remote control GPIB remote control and sample programs, while the PTA Control Part describes about PTA operation and PTL commands.

# TABLE OF CONTENTS

---

For Safety .....	iii
ABOUT THIS MANUAL .....	I
SECTION 1 BASIC OPERATION PROCEDURE .....	1-1
Signal Display .....	1-3
Marker Operation .....	1-6
"Measure" Function Check .....	1-8
Screen Hard Copy .....	1-9
SECTION 2 FREQUENCY/AMPLITUDE DATA ENTRY .....	2-1
Setting Observation Frequency .....	2-3
Setting Level Range .....	2-10
Offsetting Reference Level .....	2-15
SECTION 3 MARKER FUNCTIONS .....	3-1
Changing Zone Marker Position and Width .....	3-4
Marker Mode .....	3-7
Display Line .....	3-10
Multimarker .....	3-11
Marker Search .....	3-16
Setting Parameters Using Marker Values .....	3-22
SECTION 4 SIGNAL SEARCH FUNCTION .....	4-1
Detecting Peaks .....	4-3
Moving the Measurement Point .....	4-5

<b>SECTION 5</b>	<b>SELECTING THE DISPLAY METHOD .....</b>	<b>5-1</b>
	Display Mode .....	5-3
	Storage Mode .....	5-15
	Detection Mode .....	5-22
	Time Domain .....	5-26
<b>SECTION 6</b>	<b>SELECTING THE SWEEP METHOD .....</b>	<b>6-1</b>
	Sweep Mode .....	6-3
	Trigger Mode .....	6-5
	Zone Sweep and Signal Tracking .....	6-12
	Time Gate Function .....	6-14
	Domain Sweep .....	6-22
<b>SECTION 7</b>	<b>COUPLED FUNCTION .....</b>	<b>7-1</b>
	From Auto to Manual Operation .....	7-4
<b>SECTION 8</b>	<b>AUTOMATIC CALIBRATION AND LEVEL CORRECTION FUNCTIONS .....</b>	<b>8-1</b>
	Automatic Calibration Function CAL .....	8-3
	Preselector tuning .....	8-6
	Measurement System Level Correction .....	8-8
<b>SECTION 9</b>	<b>SYSTEM SETTING AND PRESET FUNCTION .....</b>	<b>9-1</b>
	Coupled Function Common/Independent Setting Mode .....	9-4
<b>SECTION 10</b>	<b>SAVE/RECALL FUNCTION .....</b>	<b>10-1</b>
	Internal Register .....	10-4
	Memory Card File Management .....	10-10

SECTION 11 COPY/SOUND MONITOR .....	11-1
Direct Plotting .....	11-3
Saving Screen Image Data to Memory Card .....	11-9
Displaying a Title .....	11-11
SOUND Monitor .....	11-12
SECTION 12 PTA/DEFINE FUNCTIONS .....	12-1
PTA Program Editing and Loading .....	12-3
User-Definition Function .....	12-6
SECTION 13 MEASUREMENT .....	13-1
Measure Measurement Function .....	13-3
Measurement Examples .....	13-8
SECTION 14 EXTERNAL MIXER .....	14-1
Function .....	14-4
Connecting the external mixer .....	14-5
Setting the band of the external mixer .....	14-6
Switching the external mixer on/off .....	14-6
Biasing the external mixer .....	14-6
Setting the conversion loss of the external mixer .....	14-7
Identifying the signal-Signal ID .....	14-8
APPENDIX A SOFT-KEY MENU .....	A-1
Soft-key Menu List .....	A-4
Menu Tree .....	A-6
APPENDIX B KEYWORDS INDEX .....	B-1

---

SECTION 1  
BASIC OPERATION PROCEDURE

TABLE OF CONTENTS

Signal Display .....	1-3
Turn the power on .....	1-3
Execute automatic calibration .....	1-4
Set the signal to the center of the screen .....	1-4
Enlarge and display the signal .....	1-5
Marker Operation .....	1-6
Check of the zone marker function	
The "marker → CF" function check	
"Measure" Function Check .....	1-8
Screen Hard Copy .....	1-9





# SECTION 1 BASIC OPERATION PROCEDURE

The basic operation procedure of this equipment is explained here. The operations are listed on the right. Also, the explanation will advance assuming that a 2 GHz signal is applied to the input connector. Please read this manual while operating this equipment.

(  : Panel key,  : Soft key)

<Actual operations>

- (I) Signal display
  - 1) Turn the power on,
  - 2) execute automatic calibration,
  - 3) set the signal to the center of the screen, and
  - 4) enlarge and display the signal.
- (II) Marker operation
  - Check of the zone marker function.
  - The "marker → CF" function check.
- (III) "Measure" function check
- (IV) Screen hard copy

## Signal Display

### Turn the power on

Press the standby button on the rear panel, then press the power switch (0) on the front panel. In this case, continue pressing the power switch for one second or more.

Press  Preset key.

Press  Preset All key in the menu.

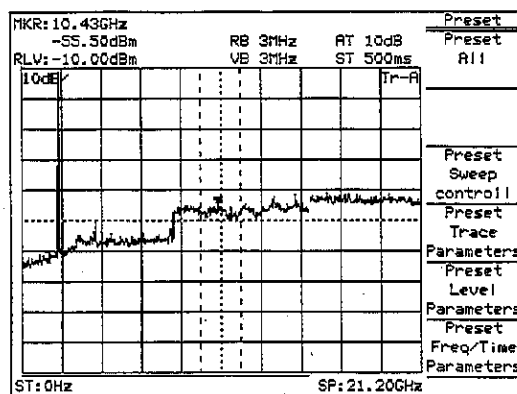

Fig. 1-1

The power is turned on/off only when the power switch is pressed for one second or more. This prevents the power from being turned on/off easily by mistake.

When  panel key (hard key) is pressed, the related soft key menu is displayed.

Partial resettings are enabled. This resetting includes only the display-related resetting or the resetting of special modes such as zone sweep.

## Execute automatic calibration

Wait after switching on the power supply of the machine (warm up period) till the internal temperature becomes stable. This period is approximately 10 minutes.

After warm up, execute automatic calibration.

Press **Shift** key then **0** key.

Select **All Cal** from the menu displayed on the display.

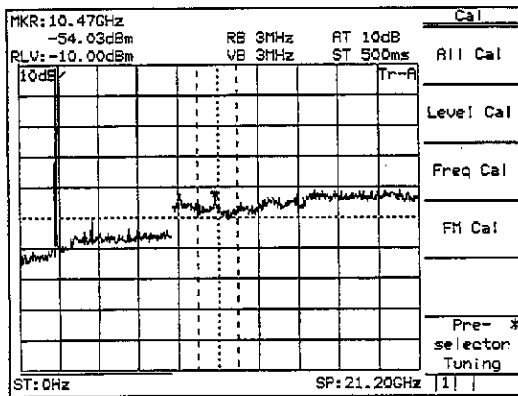

Fig. 1-2

Automatic Calibration is carried out by using an internal source without need for any external cable connection. See "Detailed Operation Instructions" for detail information about contents of calibration.

## Set the signal to the center of the screen

Press **Frequency** key.

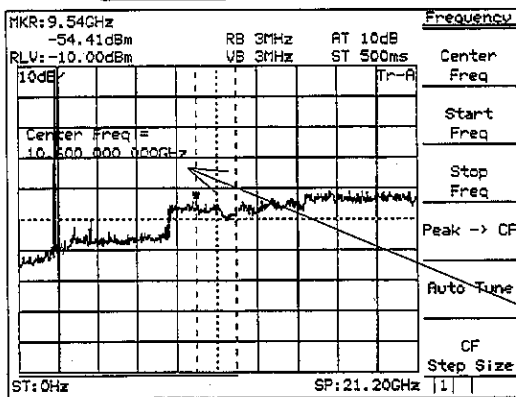

Fig. 1-3

When pressing Frequency, Span, Amplitude or Coupled Function key(s) which is used frequently, Center Frequency, Span, Reference Level, RBW or VBW function is selected and numeric value for the function can be entered into Entry area. This reduce key operation times.

This display section is called Entry area. Selecting the menu displays the current set value of the parameter. The set value can be changed by entering data in Entry area.

Press **Menu On/Off** key

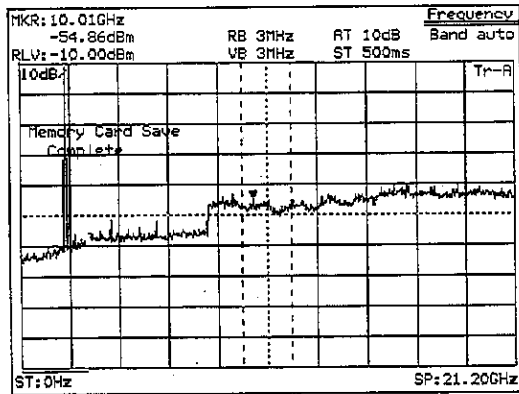

Fig. 1-4

The display of the soft key menu can be switched on/off using **Menu On/Off** key. When the menu disappears, the scale is enlarged. Also, when the menu is displayed, the scale is reduced.

Press **Menu On/Off** key to return to previous screen.

Use the ten-key pad (numeric keys) to enter 2 GHz.

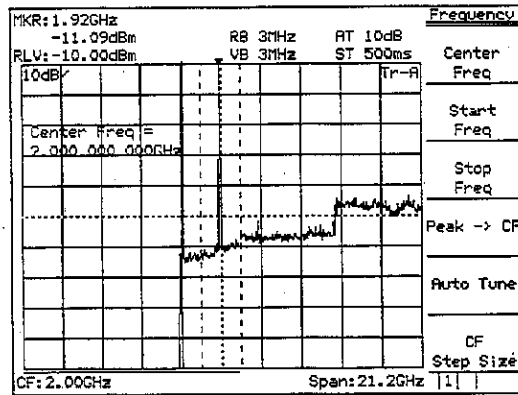

Fig. 1-5

The following three methods to input numeric values to parameters are provided: direct input by the ten-key pad (numeric keys), up/down keys, and rotary knob.

## Enlarge and display the signal

Press **Span** key, then press the **V** down key several times to enlarge the signal display.

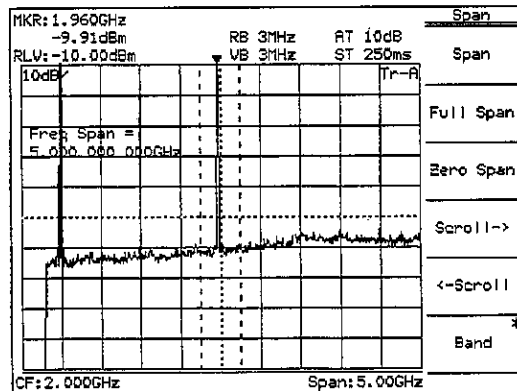

Fig. 1-6

# Marker Operation

Here, checks that the signal frequency and level are displayed in a marker display area. The zone marker automatically fetches the highest level signal within the zone and displays the frequency and level.

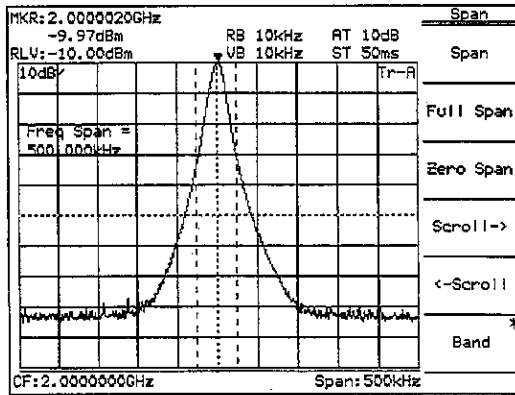

Fig. 1-7

To check Marker→ CF function, shift the signal from the center intentionally. Press **Frequency** key and **More** key in order, and then **Scroll →** key two times.

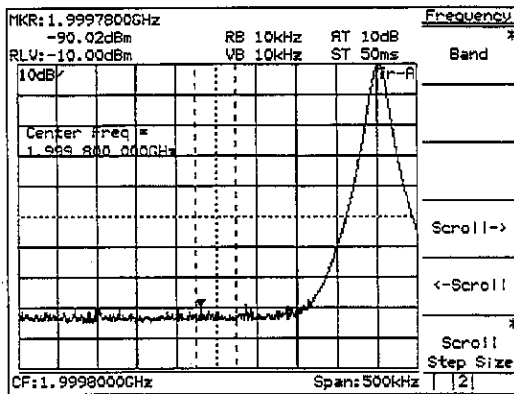

Fig. 1-8

The soft key menu marked by an asterisk on the upper right indicates that the menu can further be opened by pressing the key. Adversely, the soft key menu not marked indicates that the menu cannot be opened any more, so to speak, the end of menu opening.

The following items can easily be checked by the soft key menu tab: How many pages of the soft key menu being displayed currently are there?, and what page is displayed now?

To turn over the page, press **More** key.

Press **Peak Search** key.

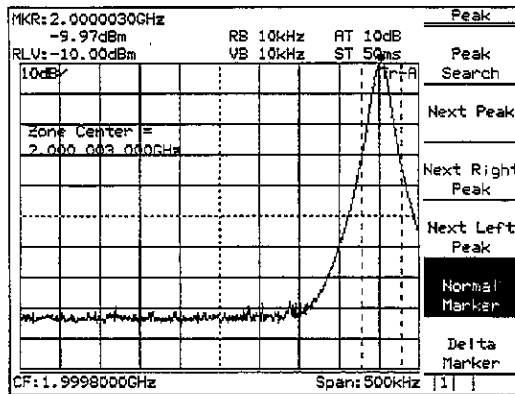

Fig. 1-9

\*Advanced operation memo: It is convenient that the page can also be turned over by repeatedly pressing the panel key. This method is used when key(s), such as **Measure** key, has a number of pages. Besides, the Freq/Ampl and Marker-related keys do not turn over the page by repeatedly pressing the panel key. For these keys, because the first page is important specially, it should always be displayed when the panel key is pressed.

The marker fetches the signal.

Press **More** key and **Marker →** key in order.

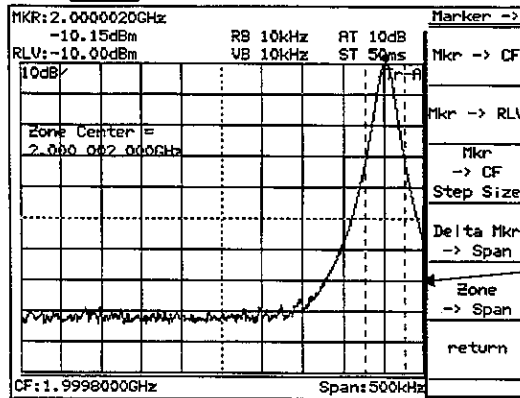

Fig. 1-10

When the soft key menu is pressed, a menu of function related to the menu is further displayed. In this case, as shown in the figure on the left, the thick line (the line on the preceding page) is displayed at the left of the soft key menu. This indicates that a new menu is overlapped with the preceding page.

Press **marker → CF** key.

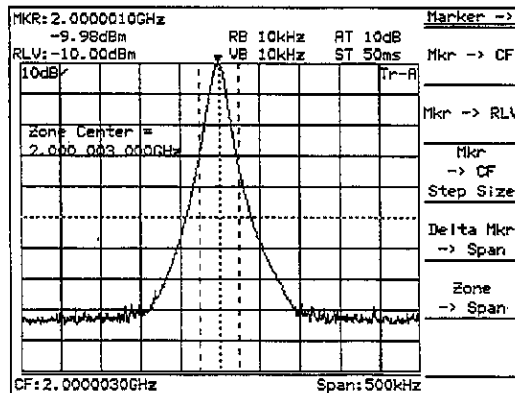

Fig. 1-11

The page opened by pressing the soft key can return to the preceding page by the **Return** key. Besides, it can be checked that which soft key menu was pressed previously to open the current menu, as the menu title is displayed on the upper row of the soft key.

Here, return to the screen of Fig. 1-8 and ensure that the screen changes to that of Fig. 1-11 only by pressing the **→ CF** key.

# "Measure" Function Check

Press **Preset** key and **Preset All** key in order.

Press **Peak Search** key.

If the zero beat signal level (local feed through) is larger than the signal level and the marker fetches the zero beat level, press "Next peak" key and put the marker on the signal.

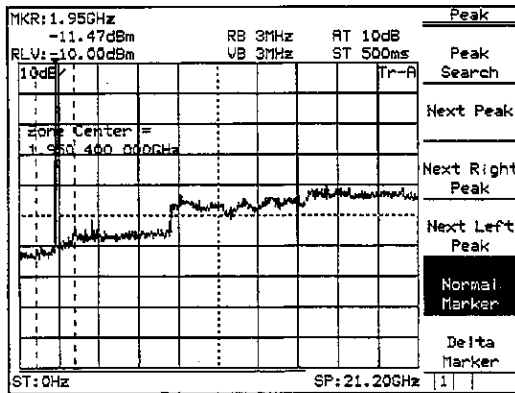

Fig. 1-12

Press the **Measure** key and **Frequency Count** key to set the function of high accuracy frequency measurement of the marker points.

Then, press the **Count On** key and start measurement.

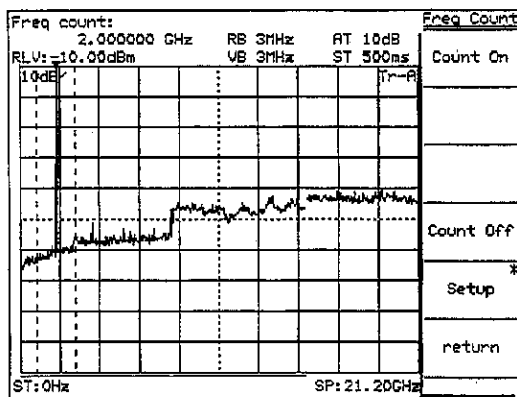

Fig. 1-13

The soft-key menu display can be switched On/Off by the **Menu On/Off** key.

However, keys that condition setting is not possible unless a menu is On unconditionally make the soft-key menu display On when pressing a panel key.

From the screen after executing measurement, press another panel key and change parameters, and then, pressing again the **Measure** key will automatically return to the menu of this screen and not to page 1 of the menu (page learning function).

It is a useful function when repeating measurement.

The frequency of marker points is displayed at the top left of the screen.

Incidentally, the internal counter correctly operates even at the full span condition, so an operation to reduce frequency span otherwise required is not necessary in this model.

## Screen Hard Copy

The screen can be hard-copied with the VP-600 printer (Epson) via an RS232C interface, and the procedures are described below:

- 1) As illustrated below, connect the RS-232C connector and printer with an attached RS-232C cable.
- 2) Press the **Copy** key, and the currently displayed screen is hard-copied.  
If the printed copy is improper, check if the RS-232C interface is correctly set in the following sequence.
- 3) Press the **Shift** key and then the **Interface** key.
- 4) Press the **Connect to Controller** key several times to get None on the display, and press the **Connect to Prt/Plt** key several times and get RS-232C on the display.  
Now the printer can be operated with RS-232C.
- 5) Press the **RS232C Setup** key and set so that (or check if) the setting of RS-232C interface is the same between the main body and printer.  
(For the setting/checking of the RS-232C interface on the printer side, refer to the instruction manual of the printer.)
- 6) Press the **Shift** key and then the **Copy Cont** key.
- 7) Press the **Printer/Plotter** key and select Printer.
- 8) Press the **Printer Setup** key, and then press the **VP-600** key.
- 9) Press the **Magnify** key several times and make the display  $1 \times 1$ .
- 10) Press the **Copy** key, and the currently displayed screen is hard-copied.

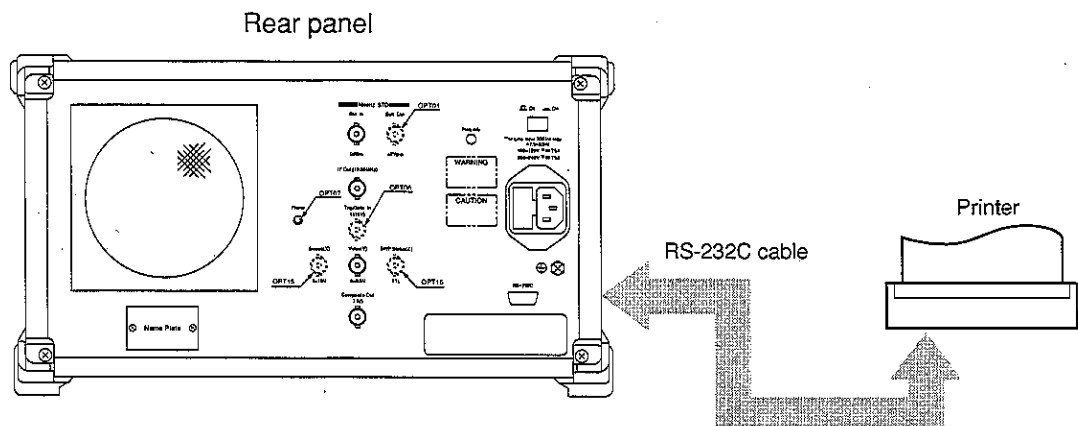

Fig. 1-14

SECTION 1 BASIC OPERATION PROCEDURE



## SECTION 2

### FREQUENCY/AMPLITUDE DATA ENTRY

This section describes the data entry function related to frequency and amplitude in the Freq/Ampl section on the front panel.

#### TABLE OF CONTENTS

Setting Observation Frequency .....	2-3
Center-Span Mode .....	2-4
Start-Stop Mode .....	2-5
Setting Step Size with Step Keys .....	2-6
Setting Frequency Scroll Step Size .....	2-6
Fixing the frequency band of MS2665C .....	2-7
Fixing the frequency band of MS2667C .....	2-8
Fixing the frequency band of MS2668C .....	2-9
Setting Full Scan .....	2-10
Setting Zero Span .....	2-11
Setting Level Range .....	2-12
Setting Log/Linear Scale .....	2-13
Selecting Reference Level Units .....	2-14
Selecting Input Impedance .....	2-14
Setting Reference Level .....	2-15
Setting Reference Level Step Size .....	2-16
Offsetting Reference Level .....	2-17
Setting Attenuator .....	2-19
Setting 50 $\Omega$ →75 $\Omega$ Impedance Transformer .....	2-19
Setting Level Frequency Correction Coefficient .....	2-20

SECTION 2 FREQUENCY/AMPLITUDE DATA ENTRY

# SECTION 2

## FREQUENCY/AMPLITUDE DATA ENTRY

### Setting Observation Frequency

The observation frequency of the spectrum analyzer is set in the following two modes:

- Center-Span
- Start-Stop

The frequency setting upper and lower limits are for the MS2665C, 0 to 21.2 GHz, for the MS2667C, 0 to 30.0 GHz, for the MS2668C, 0 to 40 GHz respectively.

The Frequency key is used as the header key for setting the frequency, and the Span key is used as the header key for setting the frequency span.

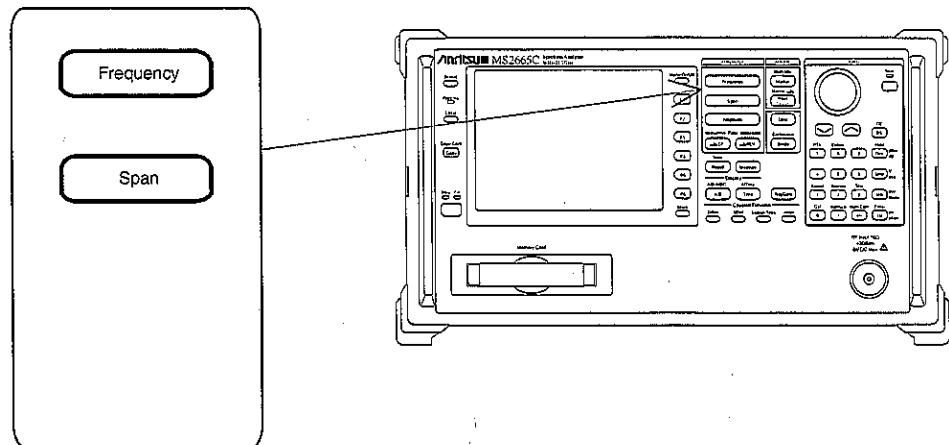

## Center-Span Mode

### (1) Setting center frequency

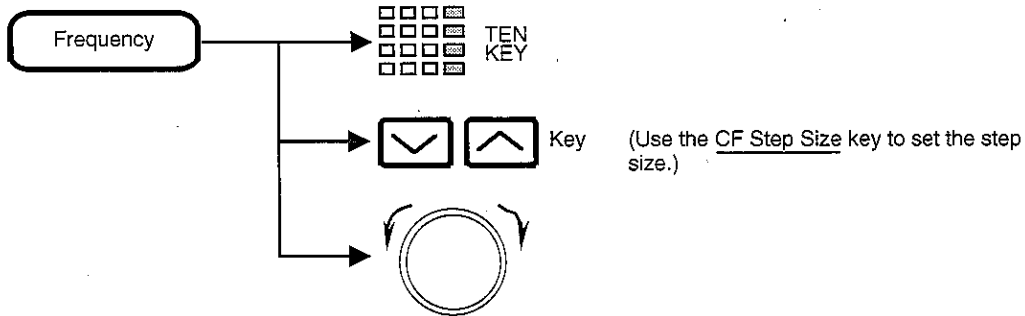

*Note:* Center frequency setting resolution is  $(1 \times N)$  Hz in frequency domain, and in case of zero span mode of MS2665C, is  $(100 \times N)$  Hz, respectively.

### (2) Setting frequency span

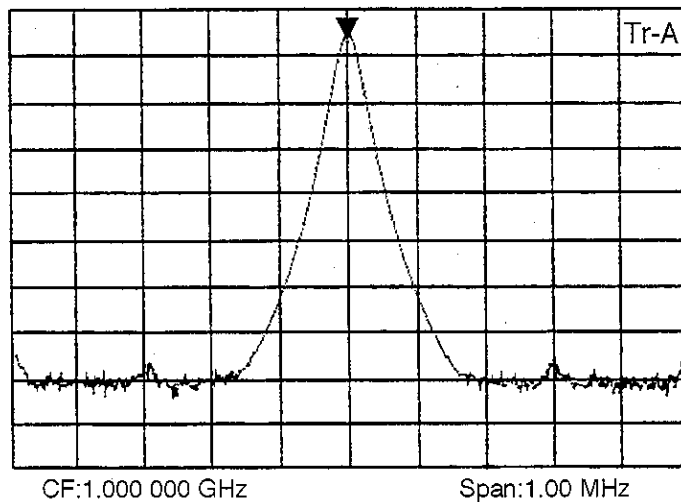
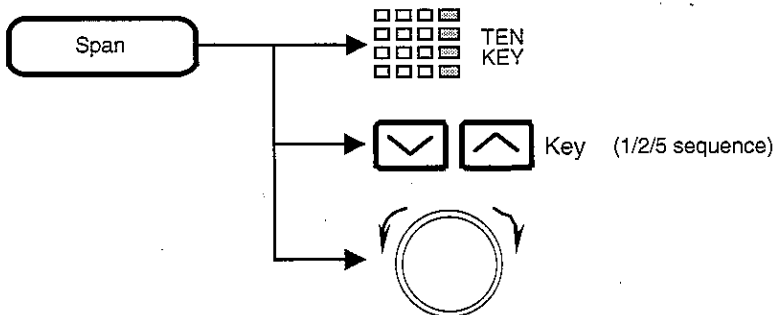

*Note:* In case of MS2665C, when frequency span is 200kHz or less, warming up might be necessary until the observation frequency becomes stable after turning on the power. When "Warm Up" message is being indicated at the top right corner of the indicator, please wait for approximately 3 minutes, and start the measurements after the message disappears.

## Start-Stop Mode

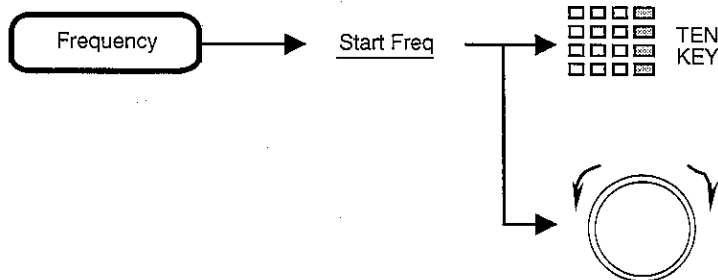

### (1) Start frequency

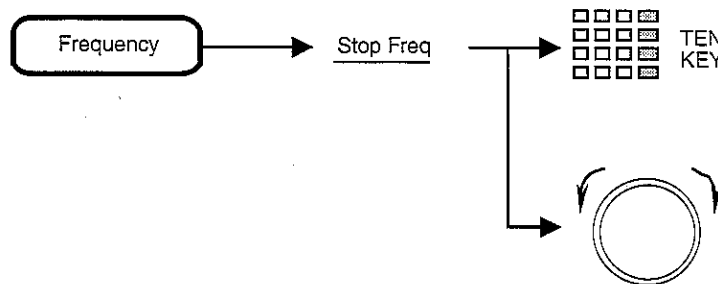

Note: Start frequency setting resolution is  $(1 \times N)$  Hz in frequency domain, and in case of zero span mode of MS2665C, is  $(100 \times N)$  Hz, respectively.

### (2) Stop frequency



- Notes:
- Because the  and  keys are the step keys for the center frequency, the start and stop frequencies are also changed.
  - The stop frequency may also vary depending on the values of the frequency span setting resolution and start frequency.
  - Stop frequency setting resolution is  $(1 \times N)$  Hz in frequency domain, and in case of zero mode of MS2665C, is  $(100 \times N)$  Hz, respectively.

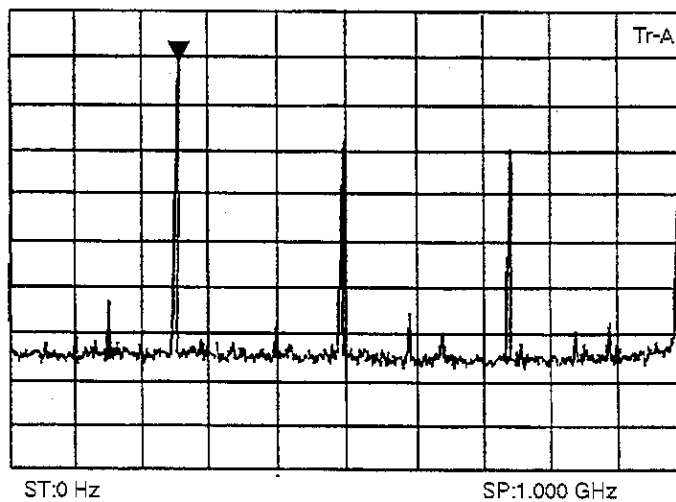

## Setting Step Size with Step Keys

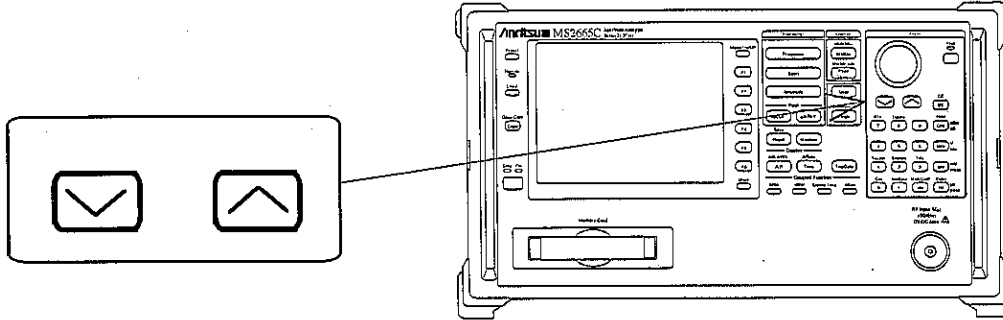

To use the ▼ ▲ keys to change the step size of the center frequency, register the step size as follows:

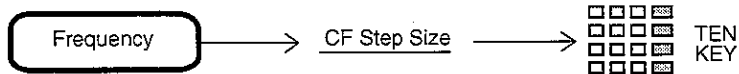

## Setting Frequency Scroll Step Size

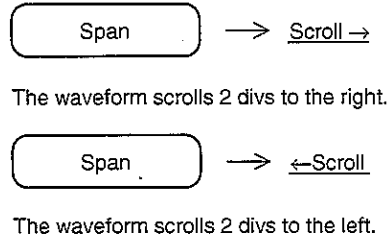
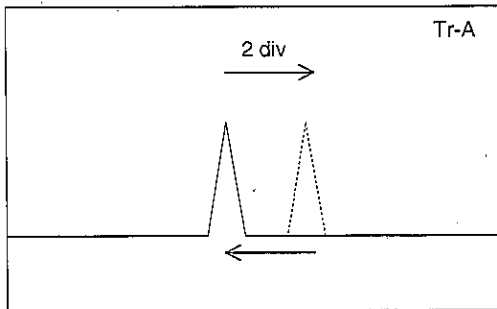
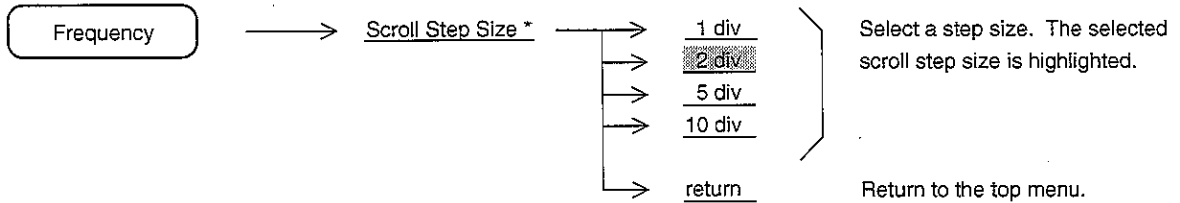

## Fixing the frequency band of MS2665C

For the MS2665C, the 0 to 21.2 GHz frequency range consists of the following five bands:

- Band 0 ..... 0 to 3.2 GHz
- Band 1<sup>-</sup> ..... 2.92 to 6.5 GHz
- Band 1<sup>+</sup> ..... 6.4 to 8.1 GHz
- Band 2<sup>+</sup> ..... 8.0 to 15.3 GHz
- Band 3<sup>+</sup> ..... 15.2 to 21.2 GHz

In the initial state, the Auto Band mode that is operated by selecting the optional frequency band is selected according to the range of frequencies to be observed.

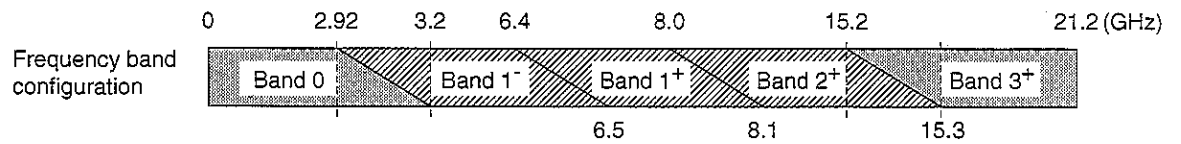

Selection of frequency bands according to range of frequencies to be observed in Auto Band mode

Perform the following to set the frequency bands, for example, when the frequency bands are switched:

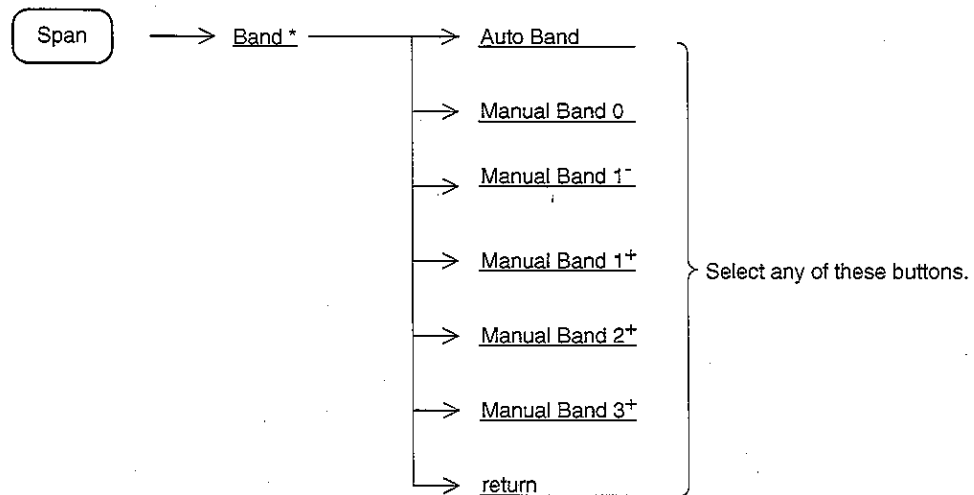

## Fixing the frequency band of MS2667C

For the MS2667C, the 0 to 30.0 GHz frequency range consists of the following six bands:

- Band 0..... 0 to 3.2 GHz
- Band 1<sup>-</sup> ..... 3.1 to 6.5 GHz
- Band 1<sup>+</sup> ..... 6.4 to 8.1 GHz
- Band 2<sup>+</sup> ..... 8.0 to 15.3 GHz
- Band 3<sup>+</sup> ..... 15.2 to 22.4 GHz
- Band 4<sup>+</sup> ..... 22.3 to 30.0 GHz

Refer to section 14 for detail of the band of external mixer. In the initial state, the AUTO Band mode that is operated by selecting the optional frequency band is selected according to be observed.

Frequency band configuration

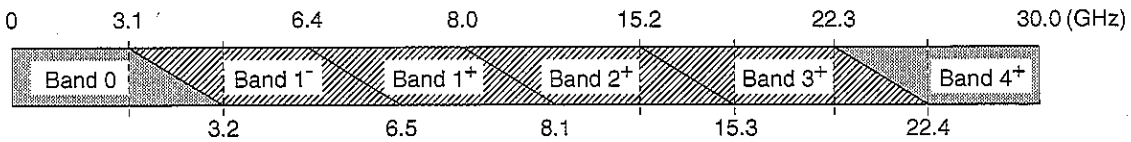

Selection of frequency bands according to range of frequencies to be observed in Auto Band mode.

Perform the following to set the frequency bands, for example, when the frequency bands are switched:

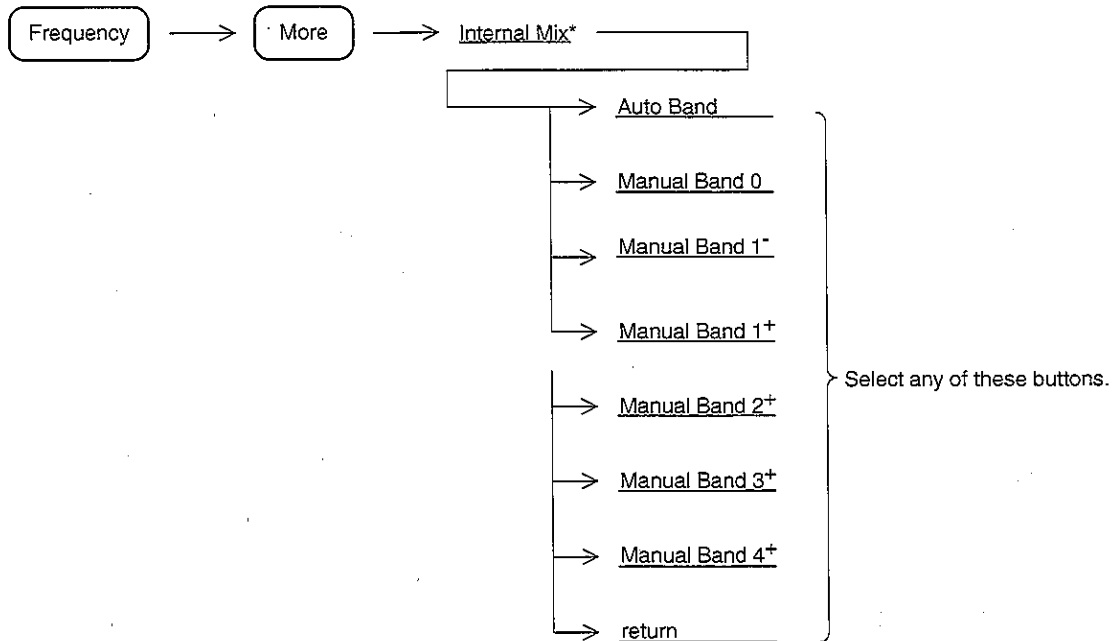



## Fixing the frequency band of MS2668C

For the MS2668C, the 0 to 40.0 GHz frequency range consists of the following six bands:

- Band 0 ..... 0 to 3.2 GHz
- Band 1<sup>-</sup> ..... 3.1 to 5.6 GHz
- Band 1<sup>+</sup> (n=1) ..... 5.4 to 8.1 GHz
- Band 1<sup>+</sup> (n=2) ..... 7.9 to 14.3 GHz
- Band 2<sup>-</sup> (n=4) ..... 14.1 to 26.5 GHz
- Band 3<sup>-</sup> (n=6) ..... 26.2 to 40 GHz

Refer to section 14 for detail of the band of external mixer. In the initial state, the AUTO Band mode that is operated by selecting the optional frequency band is selected according to be observed.

Frequency band configuration

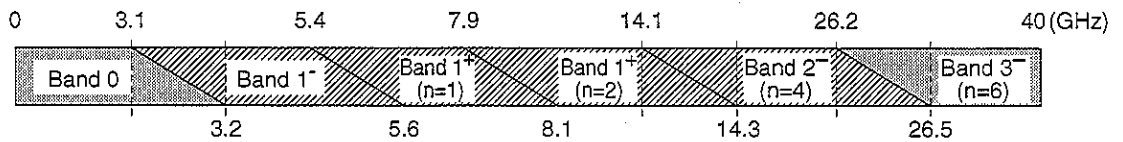

Selection of frequency bands according to range of frequencies to be observed in Auto Band mode.

Perform the following to set the frequency bands, for example, when the frequency bands are switched:

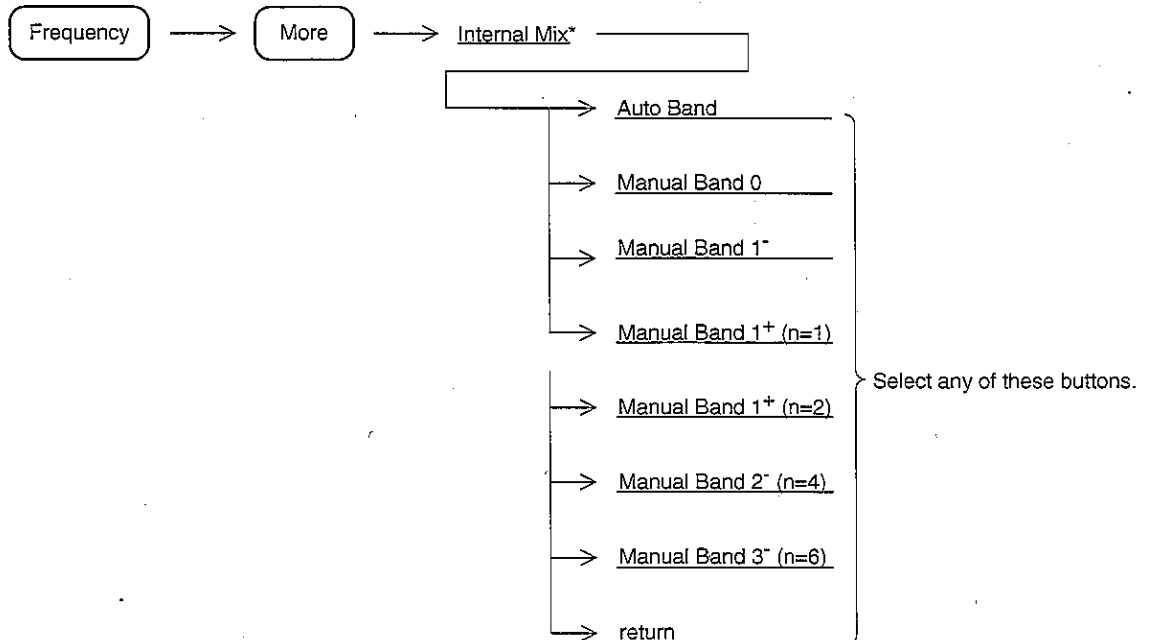

## Setting Full Scan

In the normal operating state, pressing  the key allows the entire frequency range of the spectrum analyzer to be swept over the full span. However, this setting also initializes the parameters except the frequency range.

To set the full span and leave the other parameters unchanged, perform the following key operations.

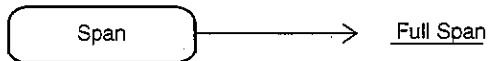



	MS2665C	MS2667C
Auto Band	0 to 21.2 GHz	0 to 30.0 GHz
Band 0	0 to 3.2 GHz	0 to 3.2 GHz
Band 1 <sup>-</sup>	2.92 to 6.5 GHz	3.1 to 6.5 GHz
Band 1 <sup>+</sup>	6.4 to 8.1 GHz	6.4 to 8.1 GHz
Band 2 <sup>+</sup>	8.0 to 15.3 GHz	8.0 to 15.3 GHz
Band 3 <sup>+</sup>	15.2 to 21.2 GHz	15.2 to 22.4 GHz
Band 4 <sup>+</sup>	—————	22.3 to 30.0 GHz
	MS2668C	
Auto Band	0 to 40 GHz	
Band 0	0 to 3.2 GHz	
Band 1 <sup>-</sup>	3.1 to 5.6 GHz	
Band 1 <sup>+</sup> (n=1)	5.4 to 8.1 GHz	
Band 1 <sup>+</sup> (n=2)	7.9 to 14.3 GHz	
Band 2 <sup>-</sup> (n=4)	14.1 to 26.5 GHz	
Band 3 <sup>-</sup> (n=6)	26.2 to 40 GHz	

## Setting Zero Span

The Spectrum Analyzer can operate as a selective level meter in which the horizontal axis is graduated as a time axis by setting the frequency span to 0 Hz. The rising and falling edges of burst waves can also be observed and measured.

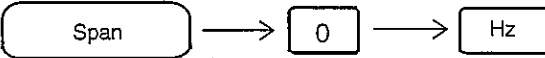
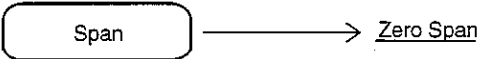
Performing any of the following key operations allows the spectrum analyzer to operate in the zero panel (time domain) mode.

-  Span → 0 → Hz
-  Span → Zero Span
-  Time

For further details on the zero span (time domain) mode, see SECTION 5, "SELECTING THE DISPLAY METHOD."

In the frequency and time domains, the RBW, VBW, Sweep time and other coupling functions time can be set to different values. For further details, see SECTION 9, "SYSTEM SETTING AND PRESET FUNCTION."

## Setting Level Range

The table below shows the types of level display modes and the ranges of the reference level (top graticule of the amplitude scale) for the different modes.

Display mode	Units	Reference level range
Log scale	dBm	-100 to +30 dBm
	dB $\mu$ V	+7 to +137 dB $\mu$ V
	dBmV	-53 to +77 dBmV
	V	2.24 $\mu$ V to 7.07 V
	dB $\mu$ V (emf)	+13 to +143 dB $\mu$ V (emf)
	W	100 fW to 1.00 W
Linear scale	V	224 $\mu$ V to 7.07 V

dBm: dBm unit system where 1 mW/50  $\Omega$  is defined as 0 dBm.

dB $\mu$ V: dB $\mu$ V unit system where 1 $\mu$ V is defined as 0 dB $\mu$ V, and the terminal voltage display is terminated into 50  $\Omega$ .

dBmV: dBmV unit system where 1 mV is defined as 0 dBmV, and the terminal voltage display is terminated into 50  $\Omega$ .

dB $\mu$ V (emf): dB $\mu$ V (emf) unit system based on the open-voltage display, and dB $\mu$ V +6 dB is fed as the output value.

The Amplitude key is used as the header key for setting the amplitude level.

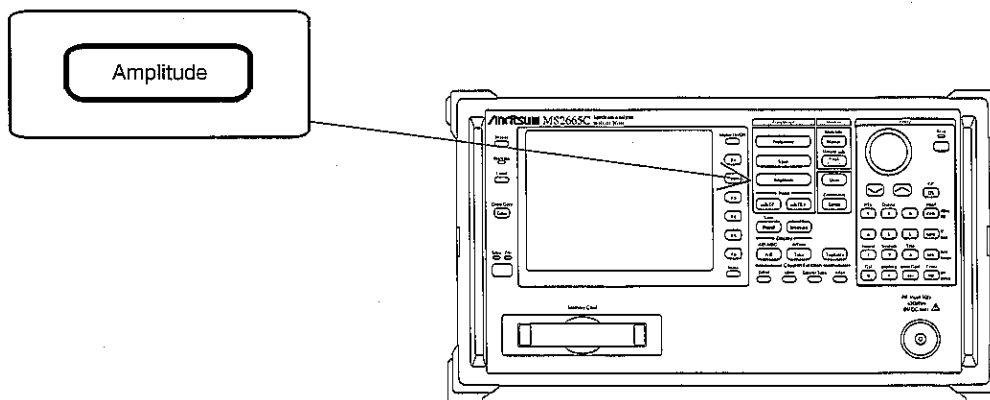

## Setting Log/Linear Scale

To set the amplitude scale to log scale or linear scale, perform the following key operations.

### (1) Setting log scale

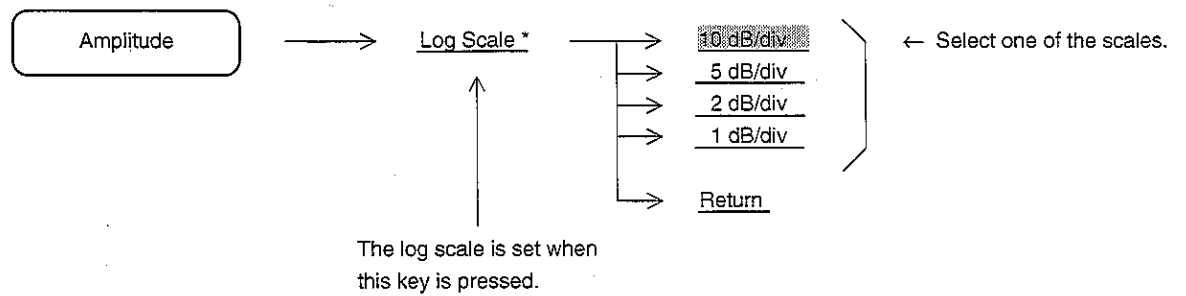

### (2) Setting linear scale

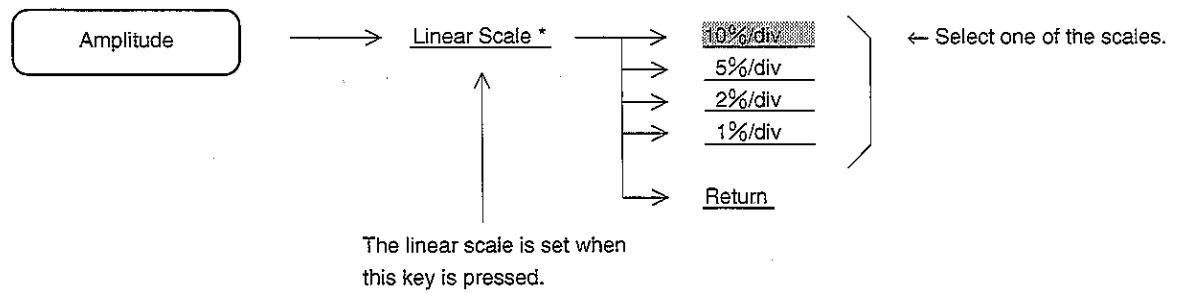

The reference level remains constant, independent of switching between log and linear scales.

When the reference level is set to less than  $-60$  dBm in the log scale mode, the reference level of the linear scale is switched to  $224 \mu\text{V}$ .

## Selecting Reference Level Units

In the log scale mode, the spectrum analyzer provides six types of reference level units: dBm, dB $\mu$ V, dBmV, V, dB $\mu$ V (emf), dB $\mu$ V/m, and W. To select one of the reference level units, perform the following key operations.

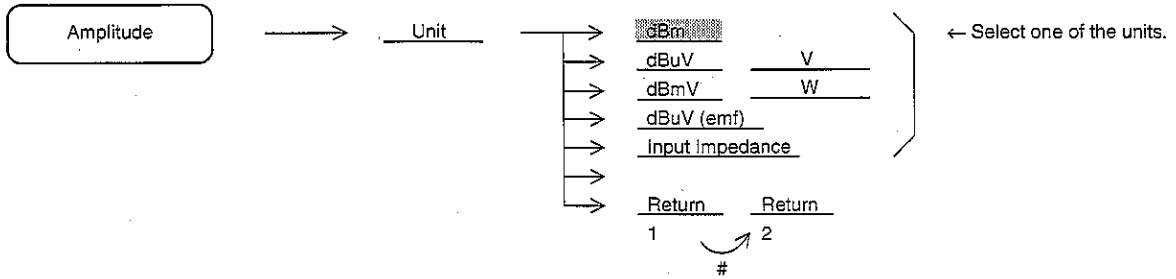

# To turn the page, press the **More** key.

Because the reference level unit used for the linear scale is only V, there is nothing to select.

## Selecting Input Impedance

The input impedance of the spectrum analyzer is 50 $\Omega$ . Measurement with 75 $\Omega$  can be enabled by using 50 $\Omega$ →75 $\Omega$  Impedance Transformer. In this case, measured value is level converted.

When the input impedance is set to 75 $\Omega$  as shown in the figure below; measured value is level converted, and displayed according to the level unit of the dB $\mu$ V/dBmV/dB $\mu$ V(emf)/V.

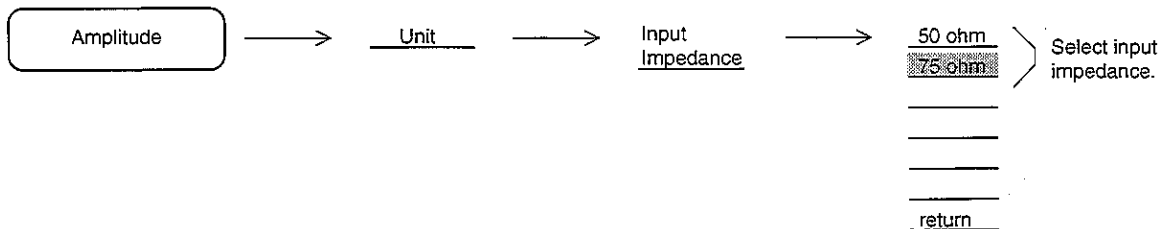

When the input impedance is set to 75 $\Omega$ , the level is displayed after adding +1.8 dB to the 50 $\Omega$  level, and "75 ohm" is displayed at the top right of the waveform.

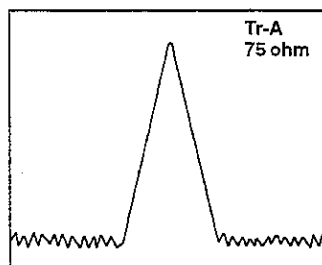

When the MA1621A is used as the 50Ω→75Ω Impedance Transformer, the insertion-loss frequency characteristics of the MA1621A must be compensated. The spectrum analyzer has the level-compensation function. (see p.2-16 "Setting 50 Ω→75 Ω Impedance Transformer (MA1621A)").

## Setting Reference Level

Select the reference level (top graticule of the amplitude scale) by performing the following key operations.

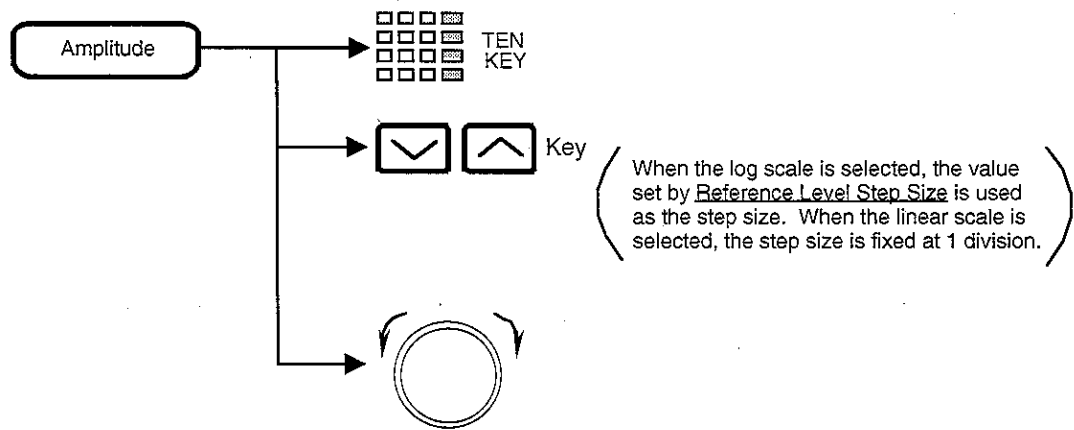

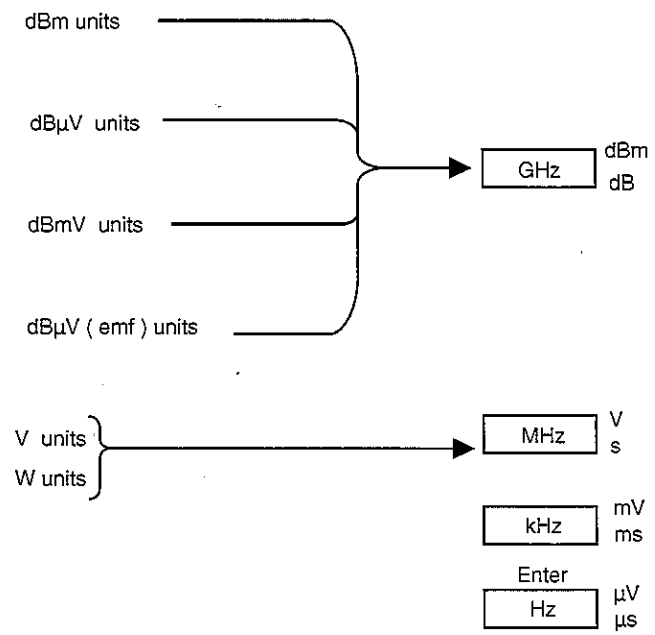

Use the unit key as follows, according to the set reference level unit.



(For W units, read V as W.)

## Setting Reference Level Step Size

To change the reference level with the   keys, set the step size by performing the following key operations.

### (1) Log scale

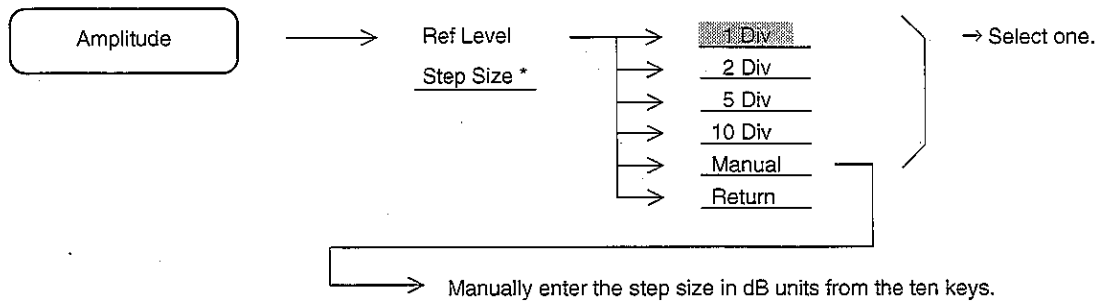

### (2) Linear scale

Fixed at 1 division.



## Offsetting Reference Level

The reference level and waveform trace can be displayed by adding a given offset.

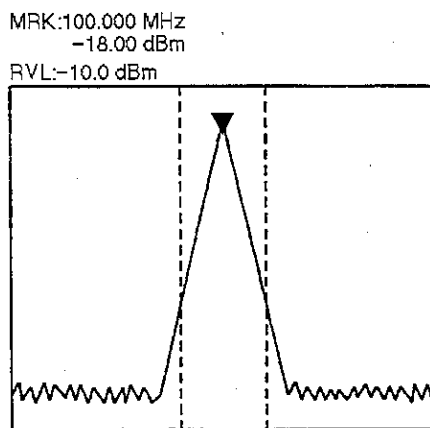

When the offset  
value is set to 30 dB.



When the offset  
value is set to -20 dB.

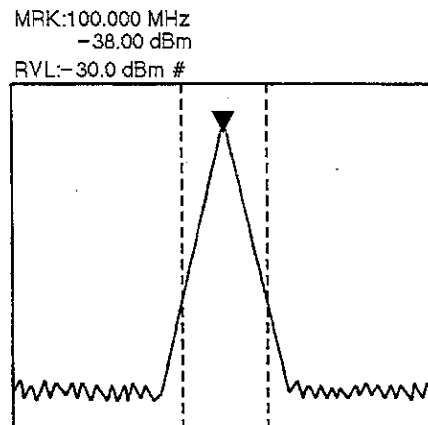
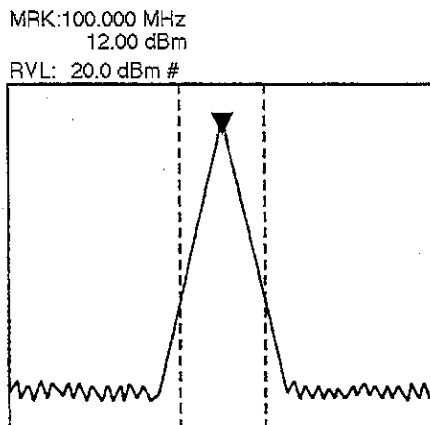

The # is displayed to the right of the reference level display above the scale.

Turn the offset display On/Off and set its offset value by performing the following key operations.

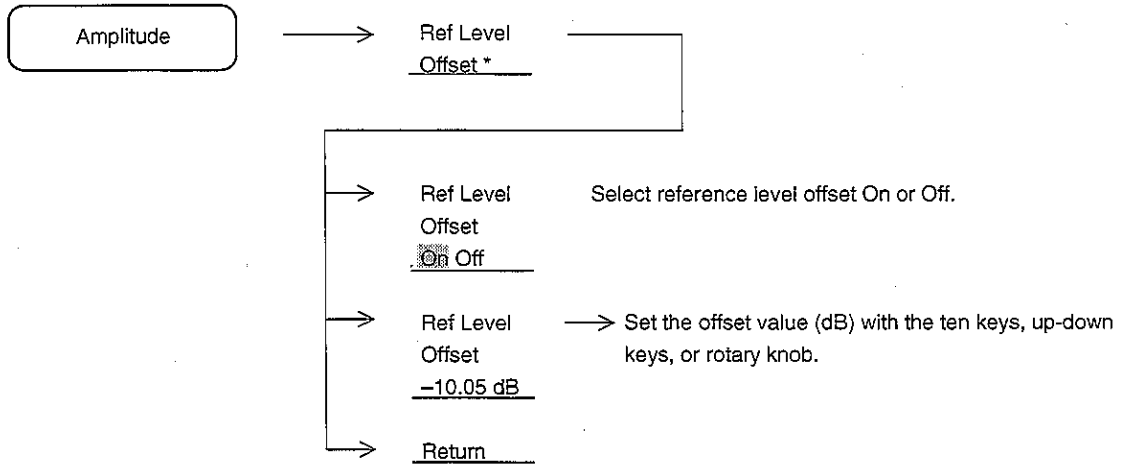

The offset value setting range is from -100 to +100 dB. The offset value resolution is 0.01 dB.

The offset can be applied to each trace (A, B, BG, Time), but it cannot be applied when monitoring FM demodulated waveforms and when using A-B→A function.

## Setting Attenuator

Press the **Amplitude** key, then press the **Attenuator** key.

Select manual setting or automatic setting.

For manual setting, enter the attenuator setting in dB units from the ten keys.

## Setting 50 $\Omega$ $\rightarrow$ 75 $\Omega$ Impedance Transformer

When the optional MA1621A (75  $\Omega$   $\rightarrow$  50  $\Omega$ ) impedance transformer is installed to the RF input attenuator (see the figure below), set the input impedance to 75  $\Omega$ .

Press the **Amplitude** key, then press the **Input Transformer** key.

Set the MA1621A to On with the On Off key.

When the input impedance is set to **On**, it is assumed that a 25  $\Omega$  resistor is connected in series with the input, the level is converted for 75  $\Omega$ , the insertion-loss frequency characteristic is corrected, and then the measured result is displayed.

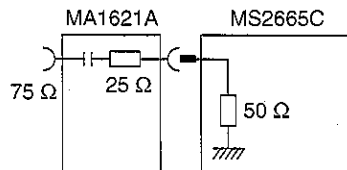

If the equipment is MS2667C/68C, recommend using the optional coaxial adaptor 34AKNF50 (K-P-N-J) when MA1621A impedance transformer is used.

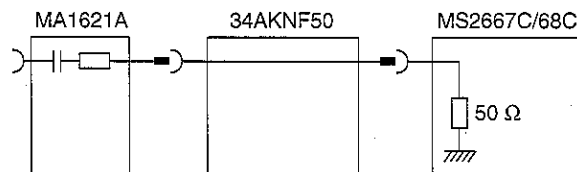

## Setting Level Frequency Correction Coefficient

This function corrects the level-frequency characteristics of the cables and pads (connected to the front end of the RF Input connector) so that the level becomes flat. Correction tables are written via the RS-232C or GPIB interface.

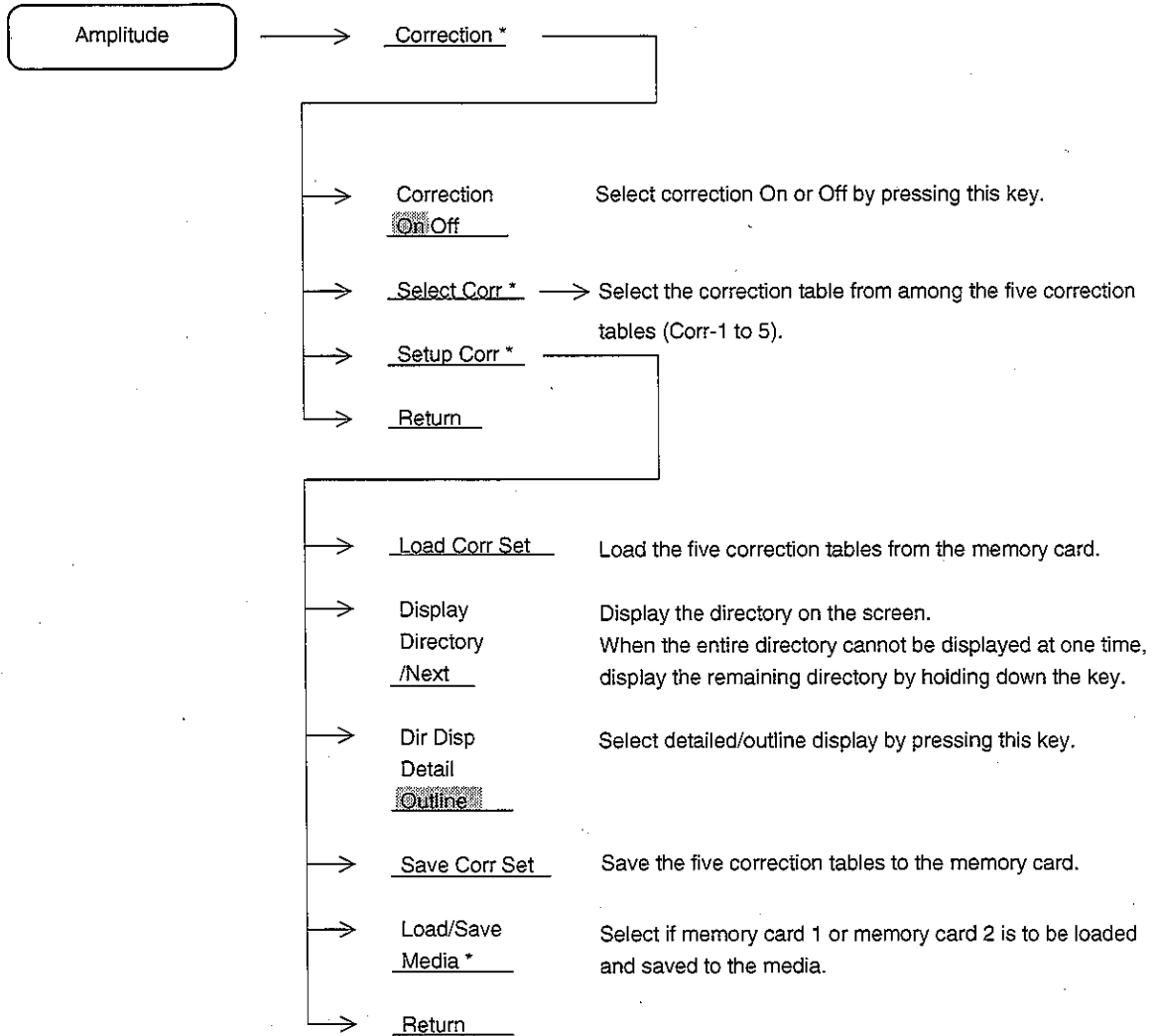

For further details, see SECTION 8.

## SECTION 3

### MARKER FUNCTIONS

This section describes the marker functions for improving the measurement efficiency, such as the zone marker, marker mode menu, marker search, and the parameters set by marker value.

For a description of marker tracking and zone sweep setting, see SECTION 6 SELECTING THE SWEEP METHOD.

### TABLE OF CONTENTS

Changing Zone Marker Position and Width .....	3-4
Changing Zone Marker Width .....	3-4
Changing Zone Marker Position .....	3-6
Marker Mode .....	3-7
Normal Marker .....	3-7
Delta Marker .....	3-8
Marker Off .....	3-9
Switching Marker Search Mode .....	3-9
Display Line .....	3-10
Setting Display Line .....	3-10
Multimarker .....	3-11
Highest 10 Multimarker .....	3-11
Harmonics Multimarker .....	3-12
Marker List .....	3-12
Manual Set .....	3-14
Multimarker Off .....	3-15
Marker Search .....	3-16
Peak Search .....	3-16
Next Peak Search .....	3-17
Next Right Peak Search/Next Left Peak Search .....	3-18
Dip Search .....	3-19

Next Dip Search .....	3-20
Setting Search Resolution .....	3-20
Setting Search Threshold .....	3-21
Setting Parameters Using Marker Values .....	3-22
Mkr → CF/Mkr → RLV .....	3-23
Mkr → CF Step Size .....	3-24
Delta Mkr → Span .....	3-25
Zone → Span .....	3-26

# SECTION 3 MARKER FUNCTIONS

The keys inner section are used as the header keys for setting the marker functions.

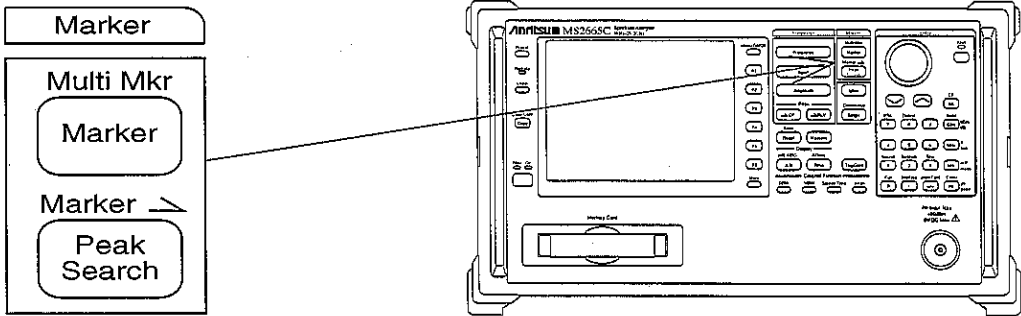

## Changing Zone Marker Position and Width

The part enclosed in dotted lines in the center of the screen shown in the figure below is called the zone marker. The current marker within this zone marker normally moves to the maximum level. The frequency (or time for time domain mode) and level at the current marker point (intensified point) are displayed at the top left-hand corner of the screen.

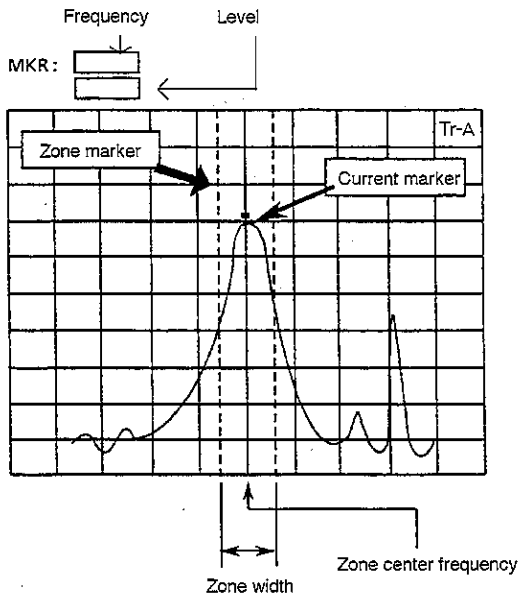

## Changing Zone Marker Width

The zone marker width is initially set to 1 division, but can be changed from 1 point to 10 divisions by performing the following key operations.



The zone marker width can be arbitrarily set from 1 point to 10 divisions by rotary knob.

The zone marker width can be arbitrarily set from 1 point to 10 divisions by the corresponding frequency input from the ten keys.



When the zone marker width is set to 1 point (Spot), the zone marker becomes a vertical line. This is called a spot marker. Since the marker center frequency and the current marker frequency coincide, the level at the desired frequency can be measured.

Example of Spot Marker (Zone Width: 1 Point)

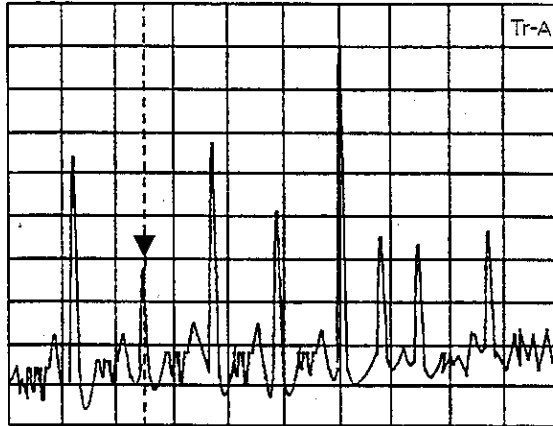

If the zone marker is set to 10 divisions when the zone center frequency is at the center of the frequency axis on the screen, the current marker will always move to the maximum peak level over the entire range of the observation frequency.

Example of Zone Width: 10 Divisions

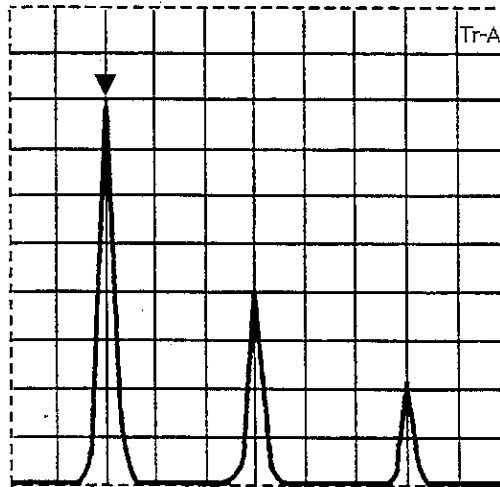

Since the zone width in the time domain mode always becomes 1 (Spot), it cannot be changed.

## Changing Zone Marker Position

The center frequency (time) of the zone marker is initially centered on the frequency (time) axis on the screen. By performing the following key operations, the zone marker can be moved from the left end to the right end of the frequency axis (time) on the screen.

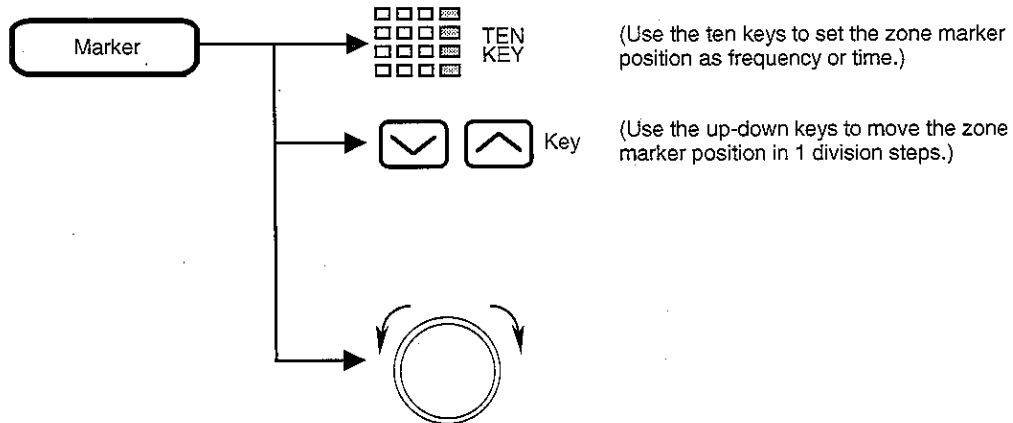

In the delta marker mode, setting the zone marker center frequency (time) with the ten keys results in entry of the delta marker value (difference between reference marker and current marker).

## Marker Mode

Three types of markers can be used with the spectrum analyzer: normal marker, delta marker, and multimarker.

### Normal Marker

A single marker is indicated by ▼ at the maximum level within the zone marker. The frequency and level at that point are displayed digitally.

The normal marker is initially set to ON. When the current state is another marker mode, or when the normal marker is set to OFF, perform the following key operations to set the normal marker to ON.

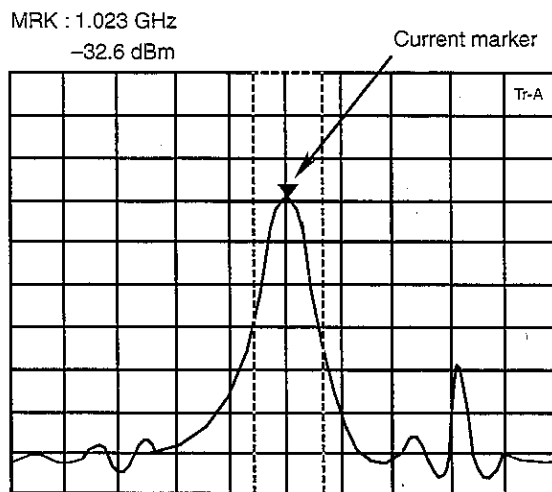
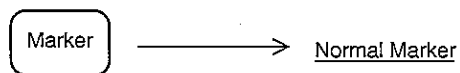

The normal marker displays the absolute level. By setting a display line, the normal marker can also display the level relative to a given level specified as a reference line.

## Delta Marker

The current marker position when the delta marker is set to On is fixed as the reference marker (reference point). Then, as the current marker is moved, the reference marker and current marker frequency (time) and level differences are displayed digitally as delta marker values.

In the delta marker mode, the reference marker is indicated by .

To set the delta marker to On, perform the following key operations.

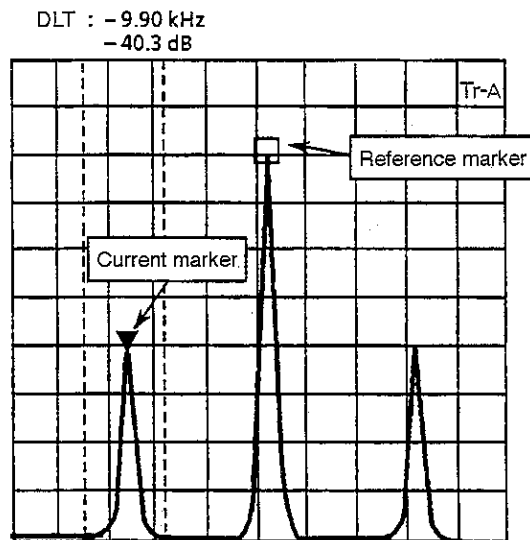
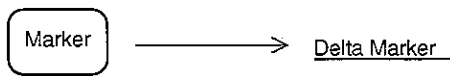

Press the Delta Marker key in the delta maker mode. The reference marker moves to the current marker position and switches to the delta marker mode with that point as the reference point.

Varying the spectrum waveform in the delta marker mode does not change the marker frequency level. The reference marker is not necessarily always on the waveform because it remains unchanged. Also, when the reference marker cannot be positioned on the screen by changing the observation frequency and level and range, it is at the edge of the scale lines.

The marker mode at delta marker-ON becomes the normal mode when the scale mode is changed from log scale to linear scale and vice-versa. If the scale mode was changed, set the delta marker again.

## Marker Off



The marker disappears from the screen. When the Normal Marker key is pressed, the marker is displayed.

## Switching Marker Search Mode

Searching the maximum value (Peak) or minimum value (Dip) in the zone marker is selected by pressing this key. Usually select Peak.

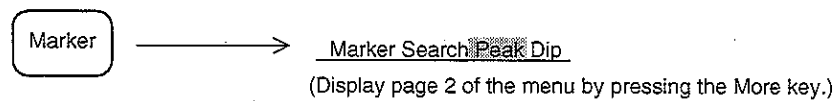

# Display Line

In the state in which a horizontal line which indicates a given level (frequency deviation for FM demodulated waveform display) is displayed on the scale, the display line can be used as the frequency response measurement guideline, or as the reference line of the marker level measurement or pass/fail judgement with a standard line.

## Setting Display Line

To turn the display-line On and Off and to set the display-line level (frequency deviation), perform the following key operations.

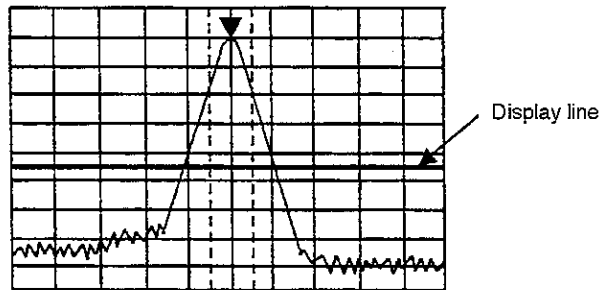
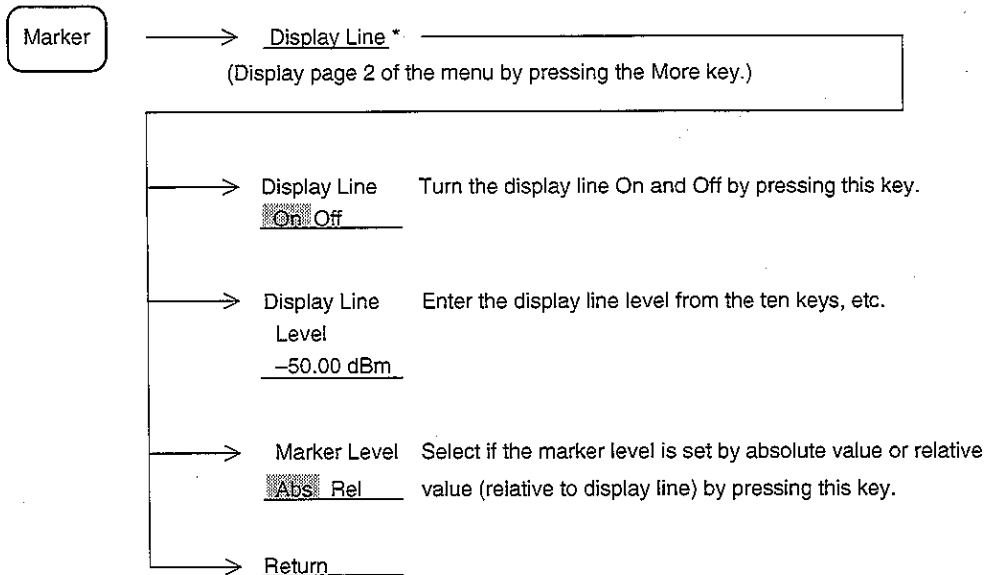

Display-line On and Off are common to all traces (A, B, BG, Time). Also, the display-line level is common except for FM demodulated waveform display.

The display-line level and Abs/Rel can be selected independently for each trace.

## Multimarker

The spectrum analyzer has a marker function which displays up to ten markers displayed simultaneously. Multimarker can be set by the following four methods:

- Highest 10
- Harmonics
- Marker List
- Manual Set

### Highest 10 Multimarker

Allocates up to 10 multimarkers in descending order of signal peak level displayed on the screen.

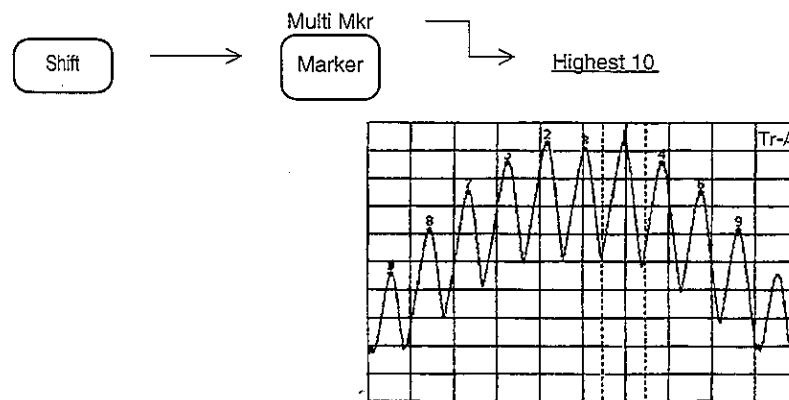

After executing Highest 10, an active marker (with the same functions as the current marker) moves to the peak point of the maximum level signal.

**Note:** Each multimarker has a zone as the same as the current marker, and is positioned at the maximum level point. So, when the next sweep is done after Highest 10 operation, each multimarker position may be changed. To protect this, execute the Highest 10 after stopping the sweeping or after narrowing the zone width.

## Harmonics Multimarker

Allocates multimarkers to the 2nd to the 10th harmonic signals of the active marker signal as the fundamental signal.

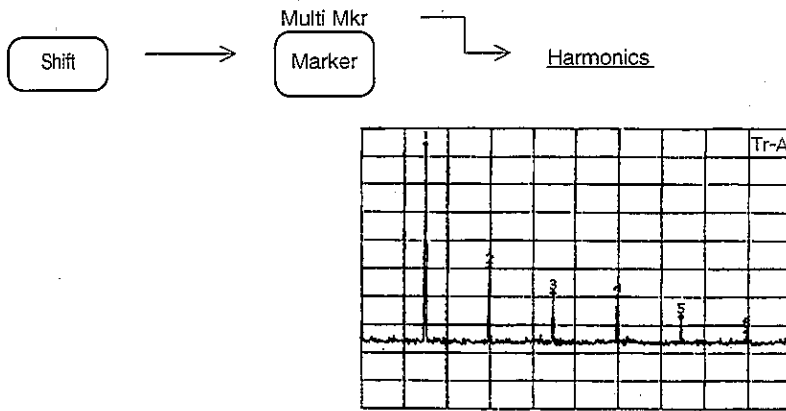

**Note:** If the fundamental and second harmonic signals are not separated by more than the marker zone width, or when there are larger level signals other than harmonic signals in the frequency range of the marker zone width centered at the harmonic signals, harmonic signals will be incorrectly detected. In this case, narrow the marker zone width.

## Marker List

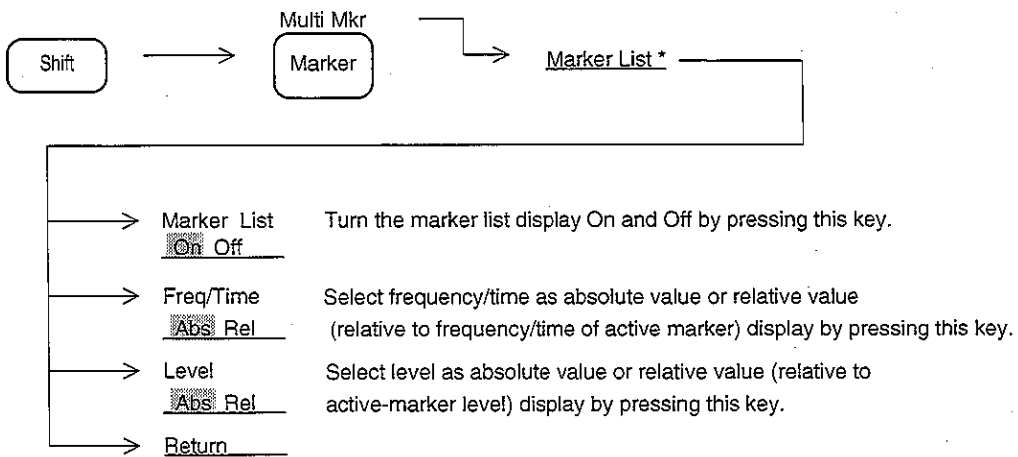



In Freq/Time Rel mode, frequency and time of the markers except active marker are displayed in relative values, and "R" marks are appended at the left.

In Level Rel mode, level of the markers except active marker are displayed in relative values,

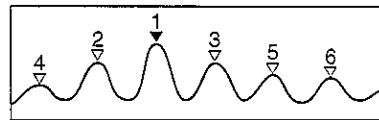

Marker List		
* 1:	1.00000GHz	-15.12dBm
2:R	-1.31MHz	-3.55dB
3:R	1.41MHz	-3.61dB
4:R	-2.00MHz	-5.96dB
5:R	1.89MHz	-6.21dB
6:R	2.20MHz	-6.76dB
7:		
8:		
9:		
10:		

# Manual Set

Allocates up to 10 multimarkers to arbitrary frequencies or time points.

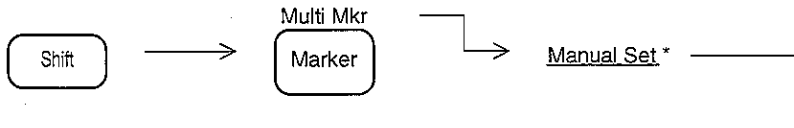

- Change Active Maker No      Selects the active marker from among the markers that are currently On. Each time this key is pressed, the markers are scrolled and selected. #
  
- Select Marker No 4      Specifies the marker number to be set to On or Off.
  
- On with Auto Select      At the same time the marker number selected above is set to On, the selected marker is made the active marker. If the selected marker is already On, the next higher marker number of the markers set to Off is set to On. By holding this key down, the multimarkers are set to On one by one in ascending order of number.
  
- <Example> When marker No.4 is selected when marker Nos. 3, 4, 5, 8, and 9 are On, the markers are turned On in No., 6, 7, 10, 1, 2 order.
  
- Off with Auto Select      Sets the marker of the selected No. to Off. If the selected marker is already Off, the next smaller marker No. of the markers set to On is set to Off. By holding down this key, the multimarkers are set to Off one by one in descending order of number. When the active marker is set to Off, the marker with the next smaller number is made the active marker.
  
- <Example> When marker No. 7 is selected to be set to Off when marker Nos. 3, 4, 5, 8 and 9 are On and marker No. 5 is made the active marker, the markers are set to Off in No. 6, 5, 4, 3, 9 order, then marker No. 8 becomes the active marker.

# The active marker is indicated by the ▼ mark. The other marker Nos. are indicated by the ▽ mark. The active marker can be moved by using the ten keys, up-down keys, or rotary knob.

Continued

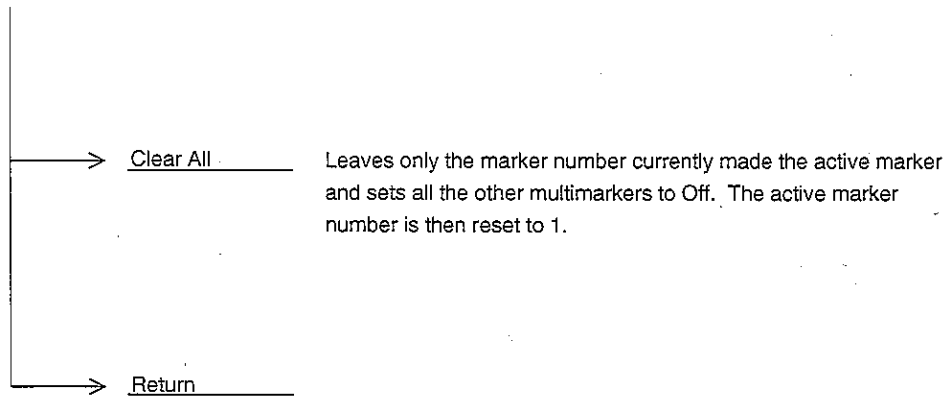

Displays the active marker value.

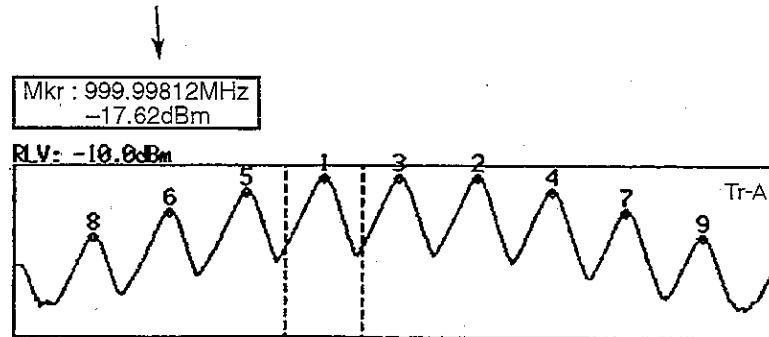

\* indicates the active marker.

MARKER LIST		
* 1:	999.998 12MHz	- 17.62dBm
2:	1.000 002 12GHz	- 17.62dBm
3:	1.000 000 00GHz	- 17.89dBm
4:	1.000 004 00GHz	- 25.88dBm
5:	999.996 00MHz	- 25.89dBm
6:	999.994 00MHz	- 37.53dBm
7:	1.000 006 04GHz	- 37.53dBm
8:	999.992 00MHz	- 52.45dBm
9:	1.000 008 04GHz	- 52.49dBm
10:		

↑  
Undisplayed markers are set to Off.

## Multimarker Off

To return from multimarker to normal marker, perform the following key operations.

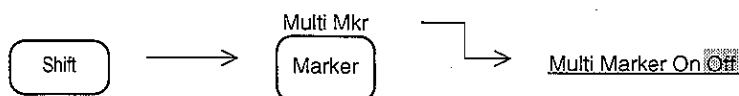

## Marker Search

The spectrum analyzer has the following six marker search functions:

- Peak search
- Next Peak search
- Next Right Peak search
- Next Left Peak search
- Dip search
- Next Dip search

## Peak Search

Peak Search detects the maximum level point from the entire trace in which a marker is displayed and moves the marker to that point.

To Execute Peak search, perform the following key operations.

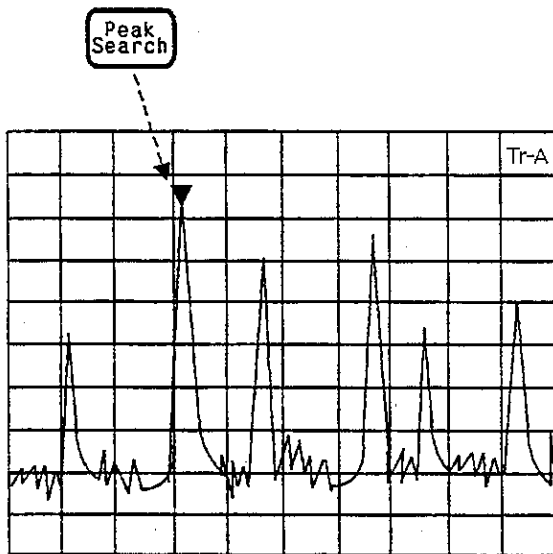

## Next Peak Search

Next Peak Search detects the next largest peak relative to the current marker level and moves the marker to that point. (When there are two or more peaks with the same level on the screen, the leftmost peak is detected.)

Execute Next Peak search by performing the following key operations.

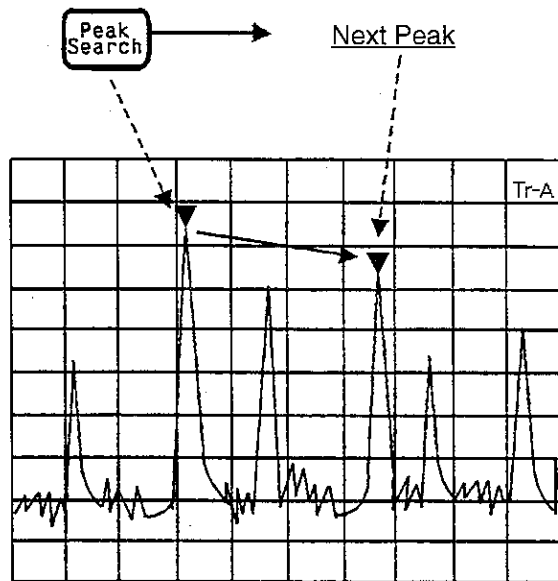

The next largest peaks can be detected and the marker can be moved to those peaks by executing Next Peak Search consecutively.

## Next Right Peak Search/Next Left Peak Search

Next Right Peak search and Next Left Peak Search detect the adjacent peak level to the right or left of the current marker and move the marker to that point.

To execute Next Right Peak Search and Next Left Peak Search, perform the following key operations.

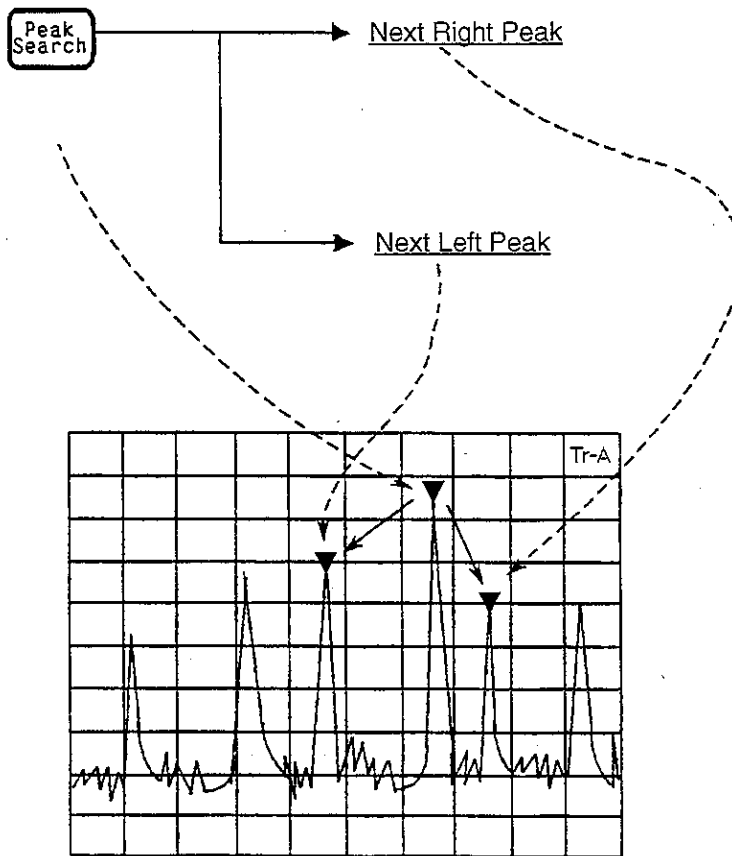

The adjacent peak level to the right or left can be detected and the marker moved to that peak by executing Next Right Peak Search or Next Left Peak Search consecutively.

**Note:** When marker search is executed, the marker is moved to the specified Peak or Dip point, and the zone marker center frequency is simultaneously moved to the marker point. After that, when sweep is executed within the zone marker, the marker moves to the maximum point within the zone marker. Therefore, marker search other than Peak search should be executed with sweep stopped or with the zone width set to 1 point (spot marker mode).

## Dip Search

Dip search detects the minimum level point from the entire trace in which a marker is displayed and moves the marker to that point.

Execute Dip search by the performing the following key operations.

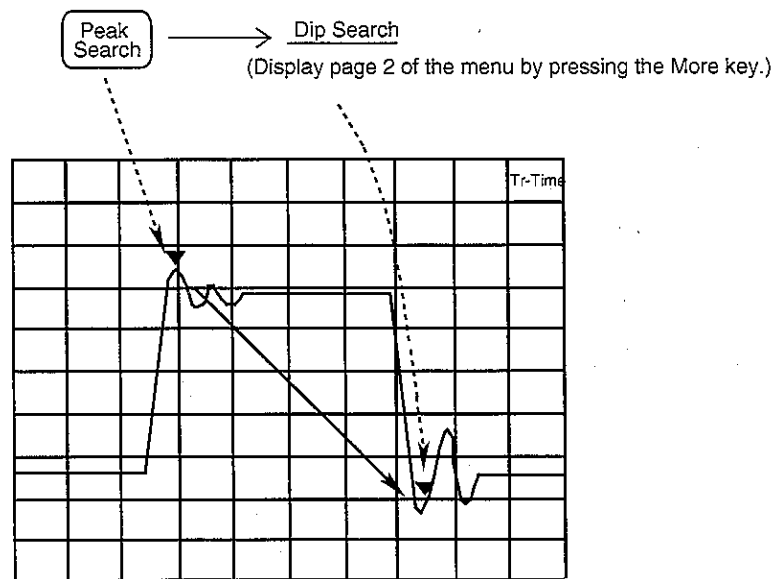

## Next Dip Search

Next Dip Search detects the next smallest dip relative to the current marker level and moves the marker to that point. (When there are two or more dips with the same level on the screen, the leftmost dip is detected.)  
 Execute Next Dip Search by performing the following key operations.

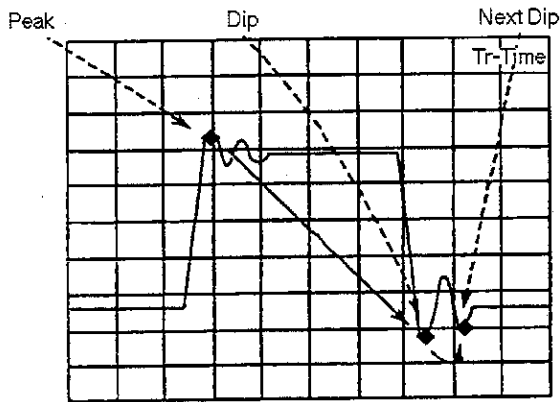
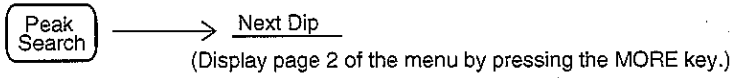

Time domain waveform

The next smallest peaks can be detected one by one and the marker moved to the detected peaks by executing Next Dip Search consecutively.

## Setting Search Resolution

Sets the Peak and Dip search resolution. When searching for the next peak, etc., the marker moves to the point of the set resolution or higher.

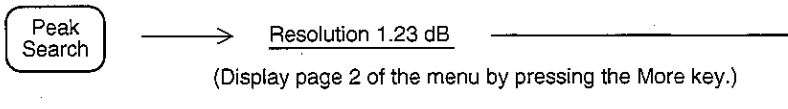

Enter the resolution in dB units from the ten keys.

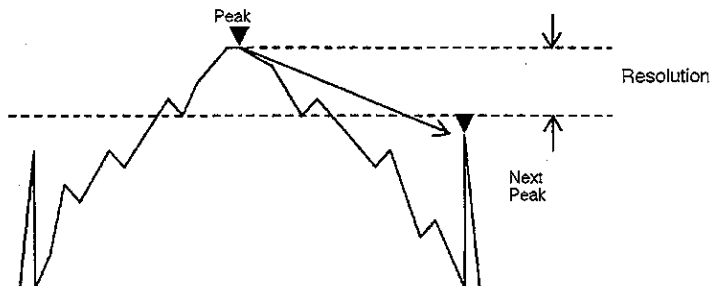



## Setting Search Threshold

Sets the display line to the threshold and searches for the level above or below the display line.

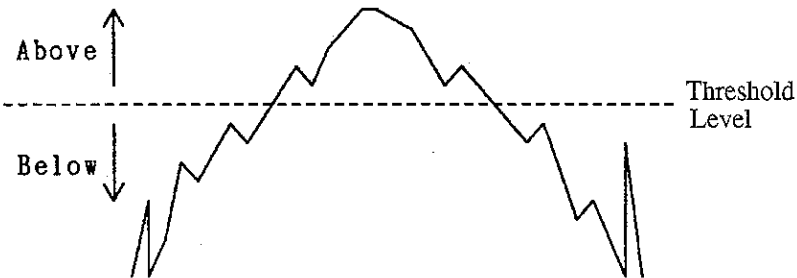
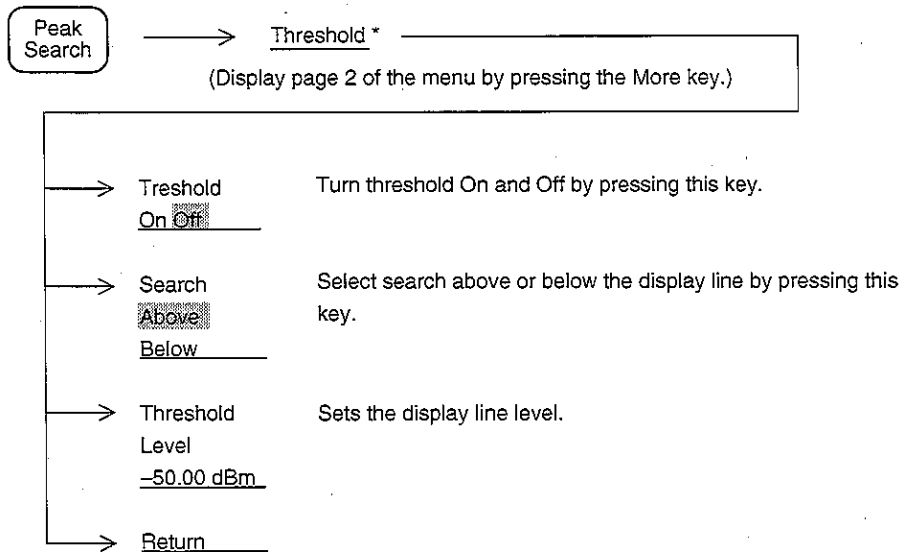

## Setting Parameters Using Marker Values

The marker value can be set as the parameter value of the observation frequency, reference level, and so on. This facilitates observation of the desired waveform.

To set parameters using the marker value, the following settings are possible:

- Mkr → CF                Sets the marker frequency to the center frequency.
- Mkr → RLV             Sets the marker level to the reference level.
- Mkr → CF Step Size   Sets the marker frequency to the center frequency step size.
- Delta Mkr → Span     Sets the reference marker and current marker frequency to the start frequency and stop frequency, respectively.
- Zone → Span           Sets the zone marker center frequency and zone width to the center frequency and frequency span, respectively.

In the time domain mode, only Mkr → RLV is valid.

Mkr → CF/Mkr → RLV

Sets the current marker frequency or level to the center frequency or reference level.

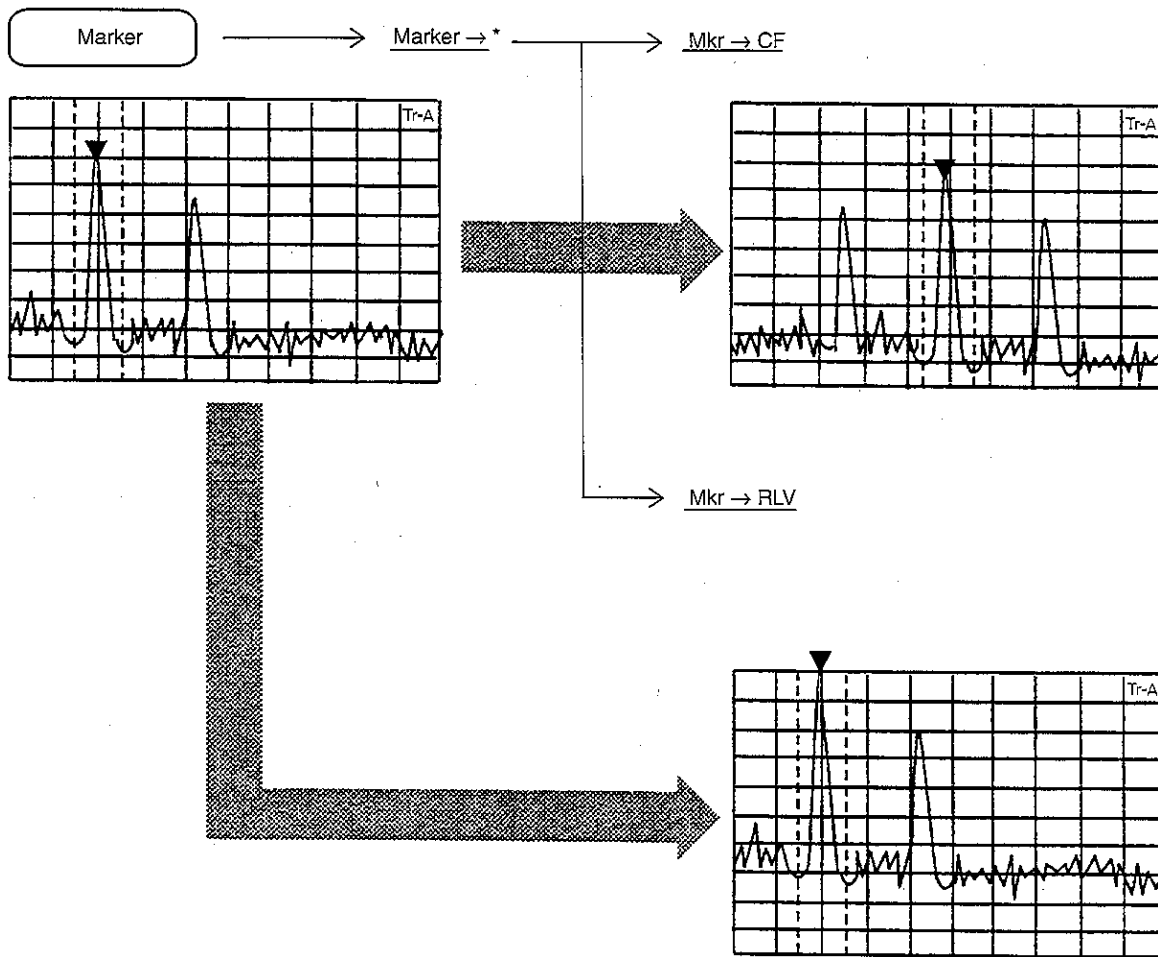

**Mkr → CF Step Size**

Sets the marker frequency to the center frequency step size (up-down keys resolution).

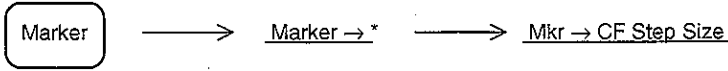

Although this action does not cause any change to appear on the screen, when the center frequency is changed with the up-down keys, the center frequency is changed with the marker frequency as the step size. This facilitates observation of harmonic waves.

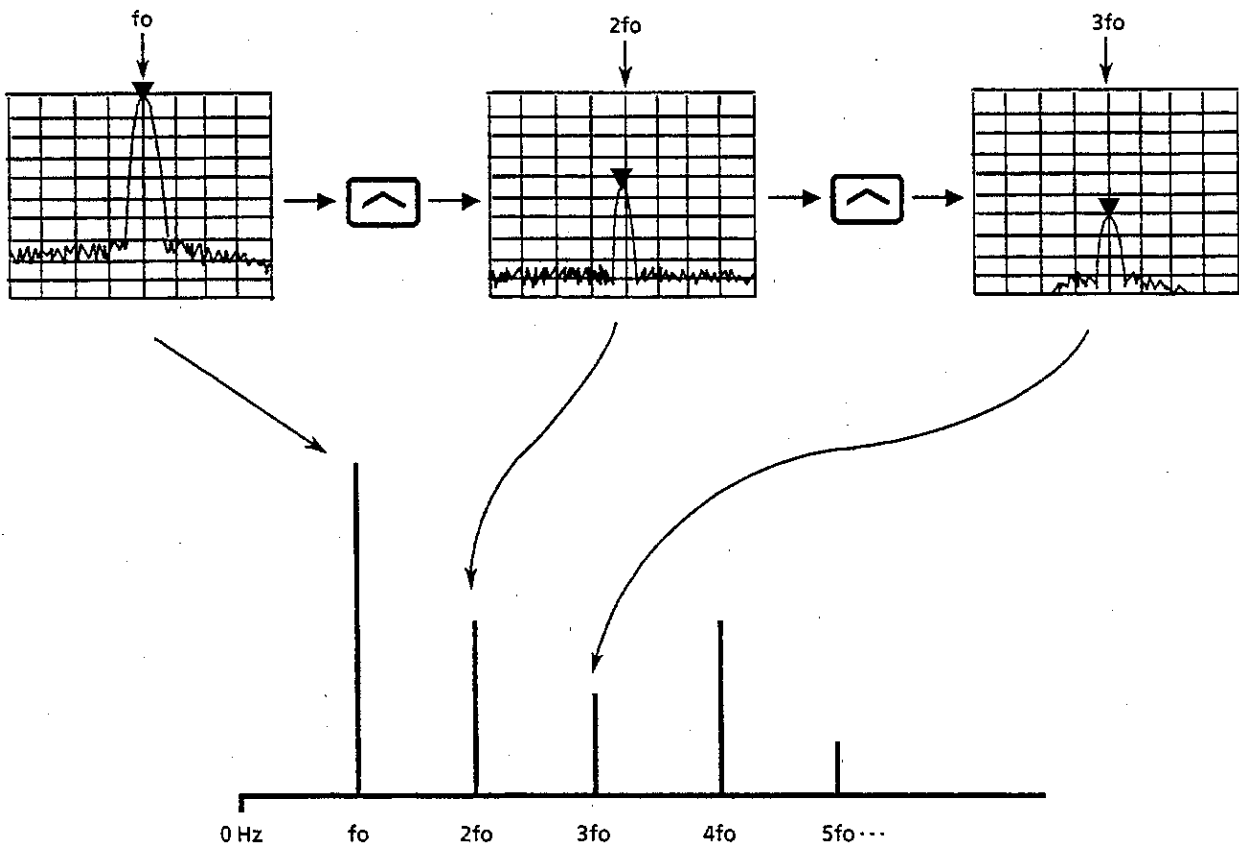

## Delta Mkr → Span

In the delta marker mode, this operation sets the delta marker mode current marker frequency and reference marker frequency to the start frequency and stop frequency, respectively.

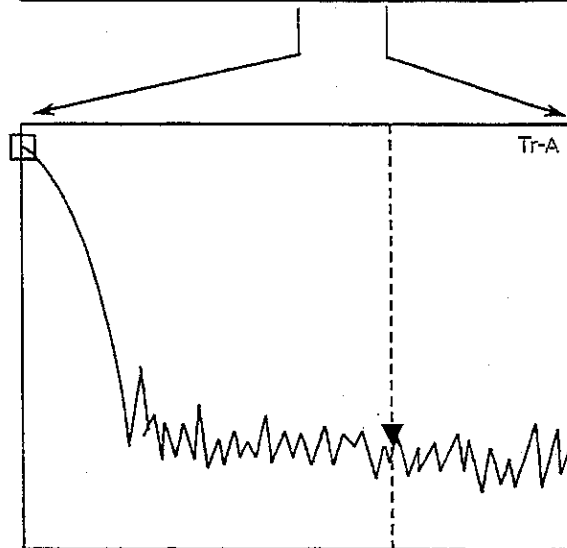
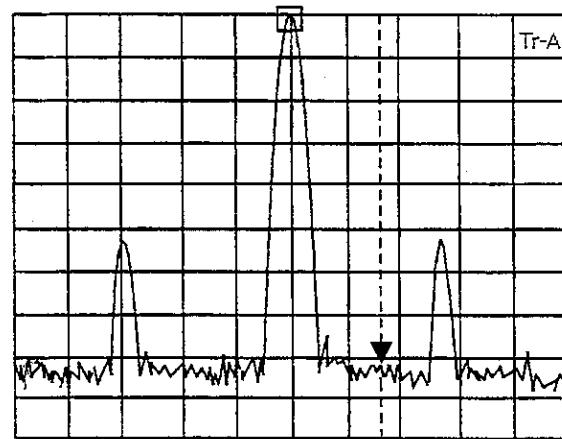
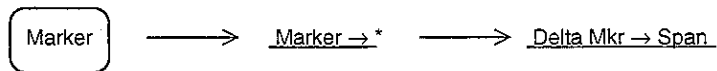

The normal marker position remains unchanged.

Since the reference marker is fixed relative to the frequency, it moves to the extreme left when the frequency span is changed.

# Zone → Span

To set the zone marker center frequency and width to the center frequency and frequency span, respectively, perform the following key operations.

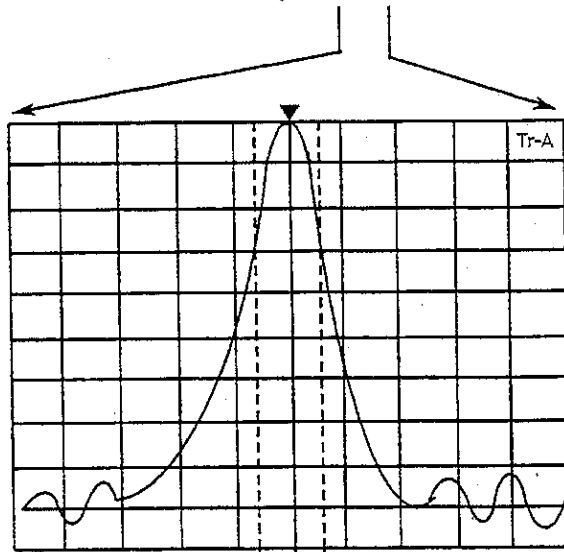
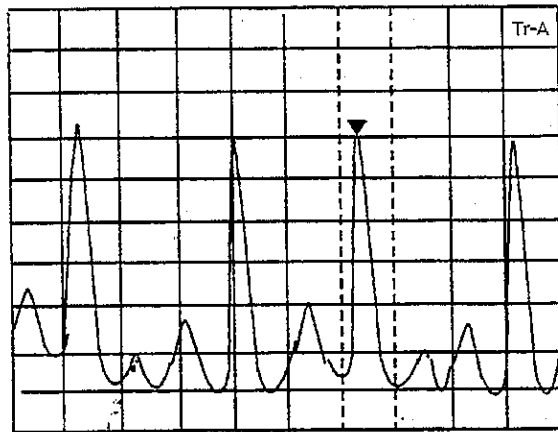
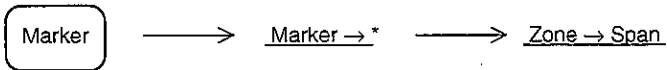

The zone width remains unchanged.

## SECTION 4

### SIGNAL SEARCH FUNCTION

Signal search facilitates extraction of the objective signal. Although the functions of signal search are similar to the marker function, this section only describes the Signal Search section.

#### TABLE OF CONTENTS

Detecting Peaks .....	4-3
Detecting the Maximum Peak Signal by Automatic Tuning .....	4-4
Moving the Measurement Point .....	4-5
Peak → CF and Peak → RLV .....	4-6





# SECTION 4 SIGNAL SEARCH FUNCTION

## Detecting Peaks

The spectrum analyzer has the following three peak detection functions:

- Auto Tune
- Zone Marker
- Marker Tracking

SECTION 3 MARKER FUNCTION describes the Zone Marker function and SECTION 6 SELECTING THE SWEEP METHOD describes the Marker Tracking function.

## Detecting the Maximum Peak Signal by Automatic Tuning

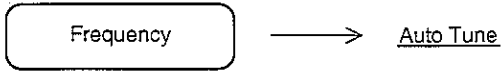

Pressing the Auto Tune key detects the maximum peak signal within the Back Ground (BG) and sets that signal frequency and level to the center frequency and reference level, respectively.

- Notes:
- When executed at a frequency span of more than 100 MHz, the frequency span is set to 100 MHz. When executed at a frequency span of less than 100 MHz, that value is retained.
  - When the Display mode was executed by trace Time, the instrument switches to trace A/Time and trace Time becomes the main trace. Also the Expand mode is set to Off.
  - The input attenuator is set to Auto.
  - In the initial state, the Auto Tune frequency range is set to 500 MHz to 21.2 GHz for the MS2665C, 900 MHz to 30 GHz for the MS2667C, 1.2 to 40 GHz for the MS2668C, respectively. By changing the trace BG frequency range, the Auto Tune frequency range can also be set as follows:

### Start frequency

Start frequency specified in trace BG

However, except the 0 Hz to 3/100 frequency span range.

### Stop frequency

Stop frequency specified in trace BG.

## Moving the Measurement Point

This function moves the spectrum on the screen to the center to facilitate measurement. The following five functions can be used.

- Mkr → CF                      Sets the marker frequency to the center frequency.
- Mkr → RLV                    Sets the marker level to the reference level.
- Peak → CF                     Sets the frequency of the maximum point on the screen to the center frequency.
- Peak → RLV                    Sets the level of the maximum level point on the screen to the reference level.
- Scroll→, Scroll←              Scroll the observation frequency.

SECTION 3 MARKER FUNCTIONS describes the Mkr → CF and Mkr → RLV functions. SECTION 2 FREQUENCY/AMPLITUDE DATA ENTRY describes the scroll function.

This section describes the Peak → CF and Peak → RLV functions.

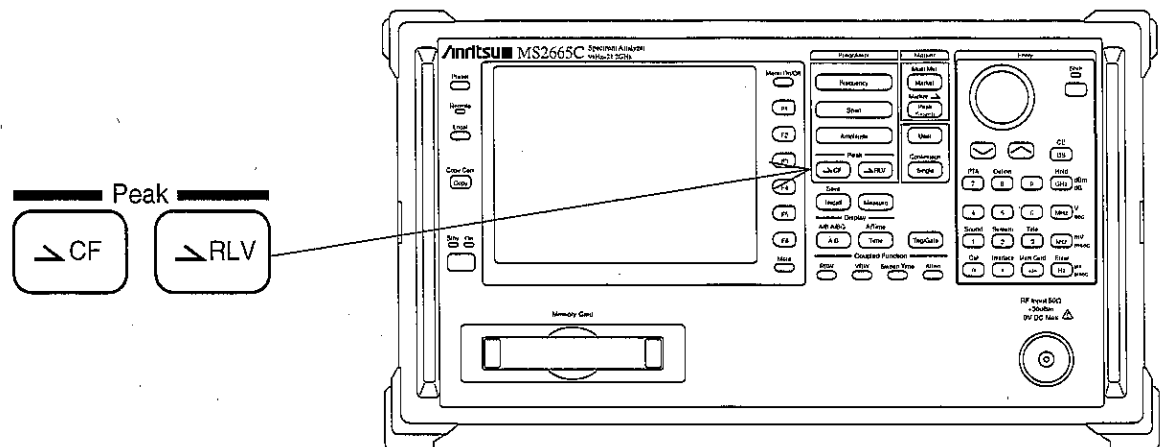

**Peak → CF and Peak → RLV**

The Peak → CF and Peak → RLV functions set the maximum level value displayed on the screen to the center frequency and reference level, respectively, and move the peak point to the center of the frequency axis on the screen and to the top level axis, respectively.

(1) Peak → CF

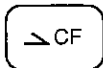

Sets the maximum peak point and the zone marker to the center frequency.

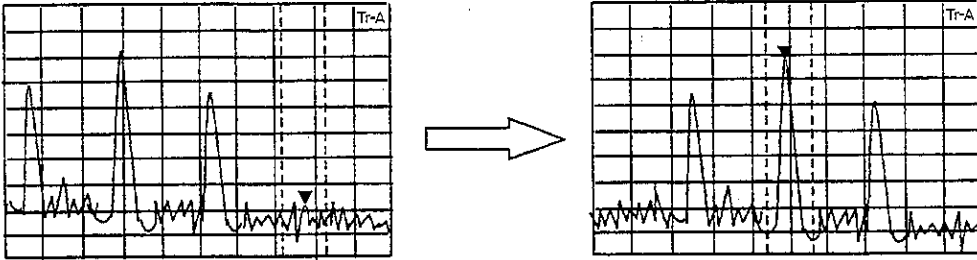

- Notes:
- When the frequency at the maximum peak point is less than 0 Hz, the center frequency is set to 0 Hz.
  - If there are two or more maximum peak points with the same level on the screen, the peak point with the lowest frequency is moved to the center frequency.
  - Peak → CF does not operate in the following cases:
    - [1] When zone sweep is On
    - [2] In the time domain mode
    - [3] When A < Time is specified in the A/Time mode

(2) Peak → RLV

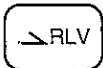

Sets the maximum peak level to the reference level.

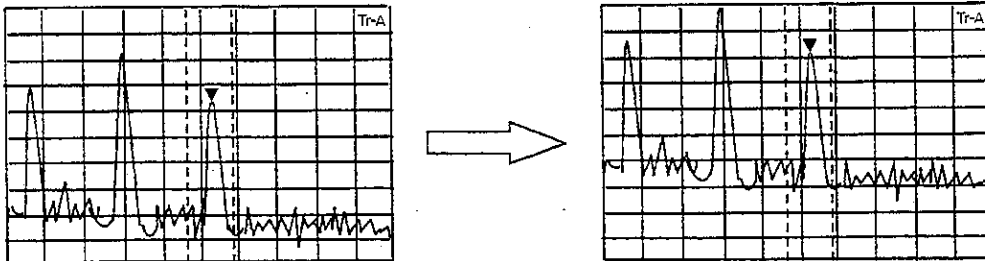

- Note:
- If the level at the peak point exceeds the permitted range for the reference level, the reference level is set to the maximum (minimum) reference level that can be set.
  - If the level at the peak point exceeds the reference level(scale over), one operation of the Peak → RLV may not be able to set the correct reference level. In this case, repeat the Peak → RLV operations a few times.

## SECTION 5

### SELECTING THE DISPLAY METHOD

This sections gives a detailed description of the display modes (Trace A/B, A/B, A/BG, Trace Time, A/Time), storage modes (Normal, Max Hold, Min Hold, Average, View, Cumulative, Overwrite), detection modes (Normal, Pos Peak, Sample, Neg Peak) and time domain analysis.

### TABLE OF CONTENTS

Display Mode .....	5-3
Trace A .....	5-5
Trace B .....	5-6
Moving the Trace .....	5-6
Trace Computation .....	5-7
Trace A and Trace B Overwrite Display .....	5-8
Setting Active Trace .....	5-8
Trace A/Trace B Top and Bottom Split Display .....	5-9
Setting Sub-trace Sweep .....	5-10
Trace A/Trace BG Top and Bottom Split Display .....	5-11
Trace Time .....	5-12
Trace A/Trace Time Top and Bottom Split Display .....	5-14
Storage Mode .....	5-15
Setting Storage Mode .....	5-17
Averaging Function .....	5-18
Max hold, Min hold Functions .....	5-21
Detection Mode .....	5-22
Selecting Detection Mode .....	5-23
Selecting Measured Level by Detection Mode .....	5-24
Time Domain .....	5-26
Setting Time Domain .....	5-26
Setting Time Span .....	5-27
Time Domain Expanded Display .....	5-28
Monitoring FM Demodulated Waveforms .....	5-30



# SECTION 5 SELECTING THE DISPLAY METHOD

The spectrum analyzer can display four trace modes (BG †, A, B, Time) in six Display modes (A, B, Time, A/B, A/BG, A/Time).

In the Display mode, the two keys of the Display section shown below are used.

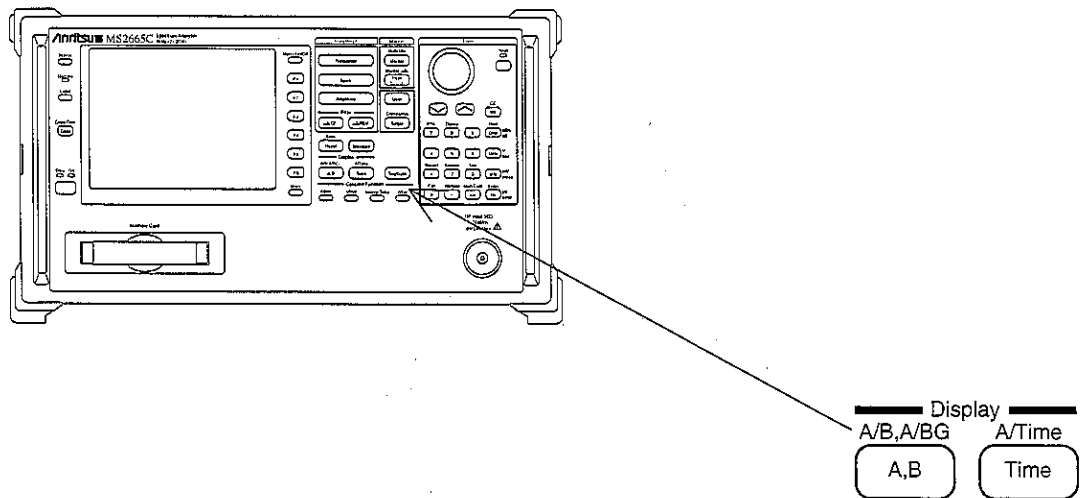

## Display Mode

The following outlines the trace modes. The figure on the next pages shows the correlation between trace modes.

- Trace BG ..... When the objective signal is measured in the trace A, B, or Time mode, the trace BG mode allows the frequency range to be observed to be pre-set to a wide band. The BG band is initially set to full span.
- Trace A, trace B ..... Used to analyze signals in the normal frequency domain. The BG zone within trace BG is expanded and displayed. Different frequency range can be observed by Trace A and Trace B.
- Trace Time ..... Displays the time axis waveform at the center frequency of trace A. Trace Time can also display FM and EXT TRIG input signals, when monitored.

† BG (Back Ground)

SECTION 5 SELECTING THE DISPLAY METHOD

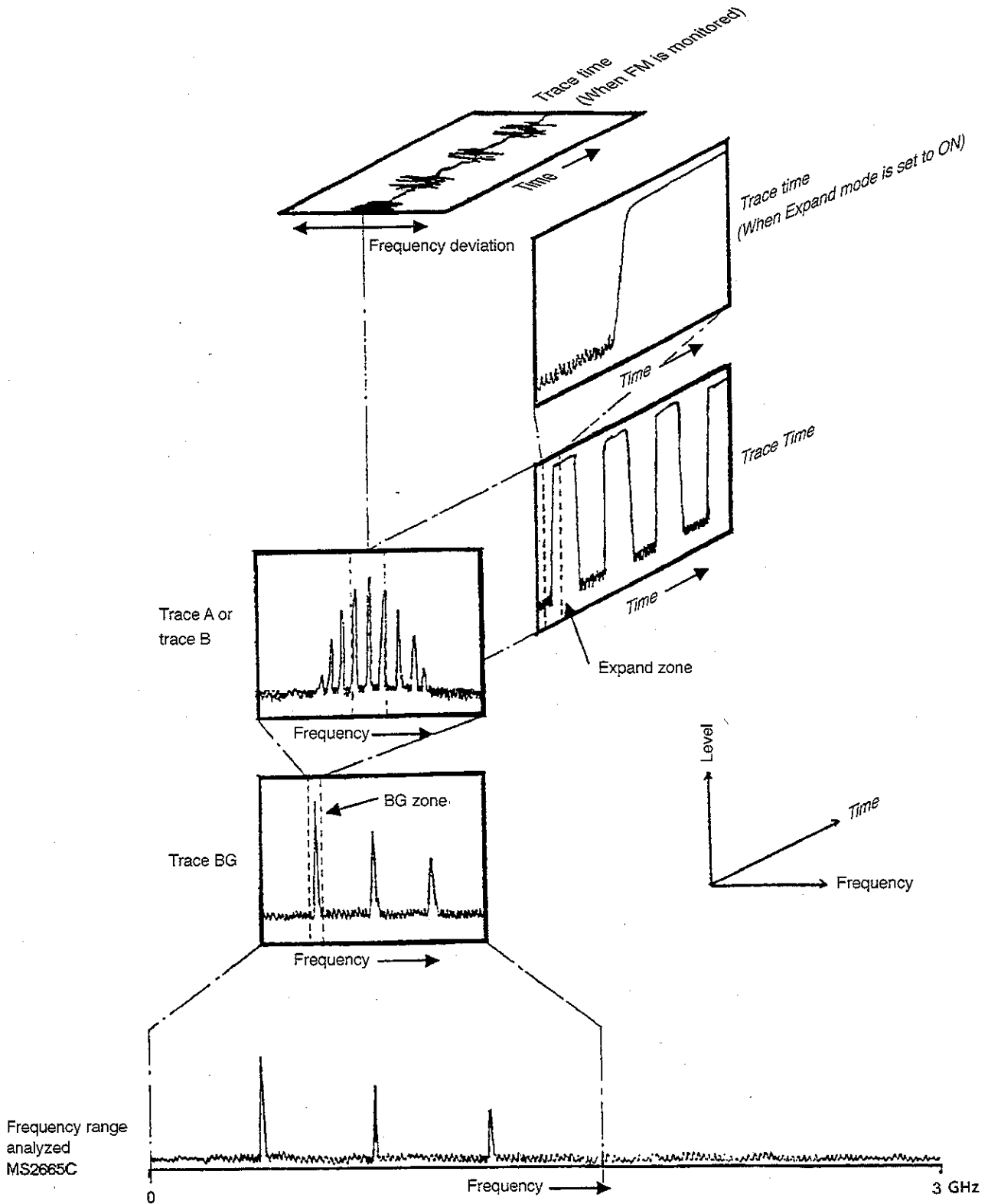



# Trace A

Trace A is used to analyze signals in the normal frequency domain.

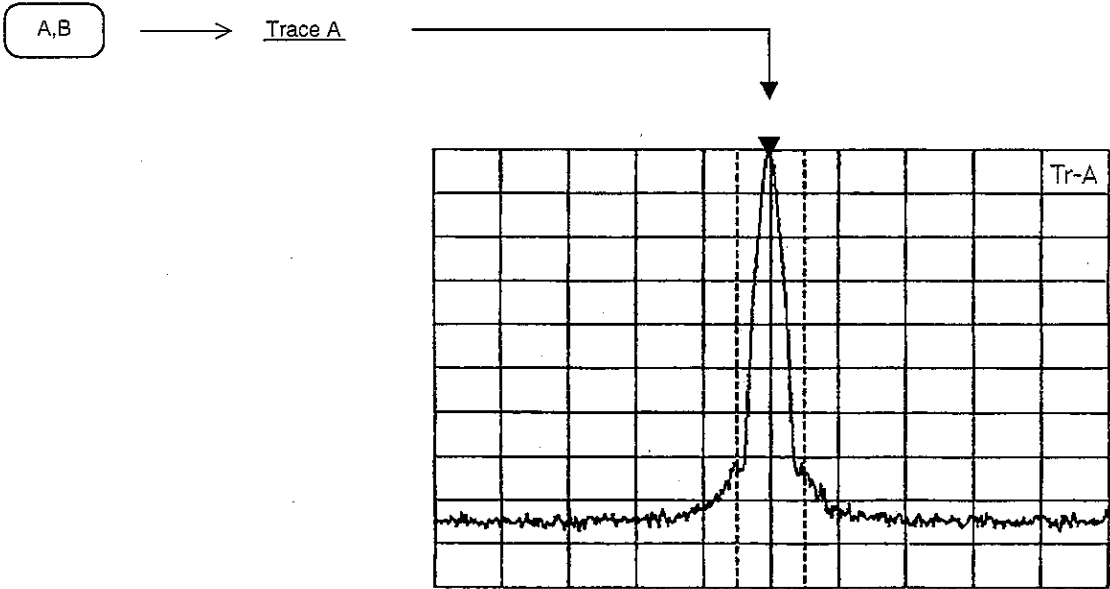

## Trace B

Like trace A, trace B is used to analyze signals in the normal frequency domain. When used with trace A, it is possible to compare waveform A and waveform B.

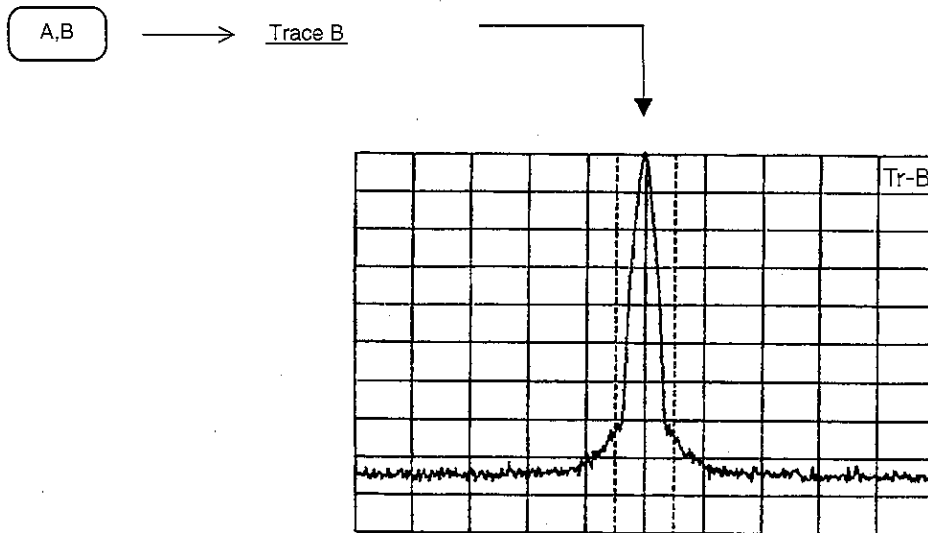

Parameters of the trace A and trace B can be set independently.

## Moving the Trace

This function moves and adds the trace A and trace B displays once.

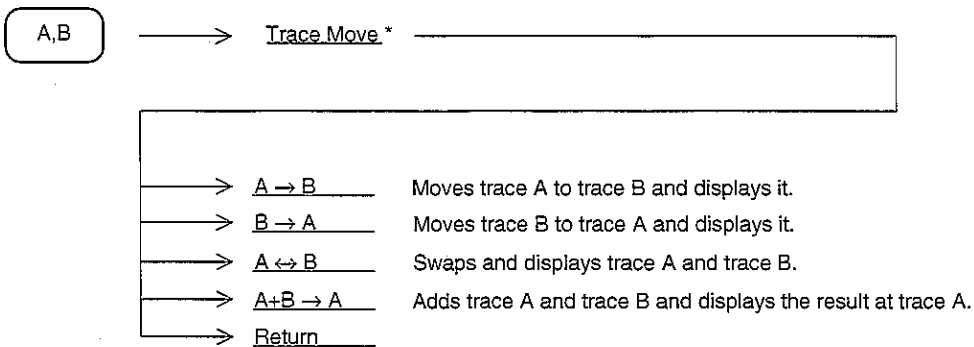

Set the move-destination-trace storage mode to View, and stop the sweeping before moving the trace. If the trace A or trace B threshold is set to any other mode, the trace data will be displayed once, then updated.

## Trace Computation

This function continuously displays the difference between trace A and trace B. Normally set trace B to the View mode before executing this function.

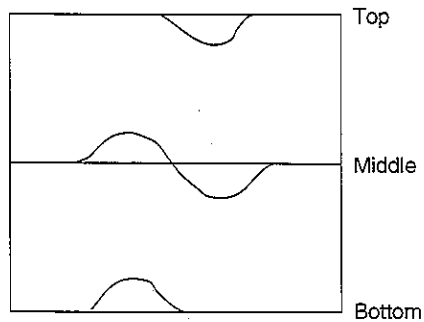
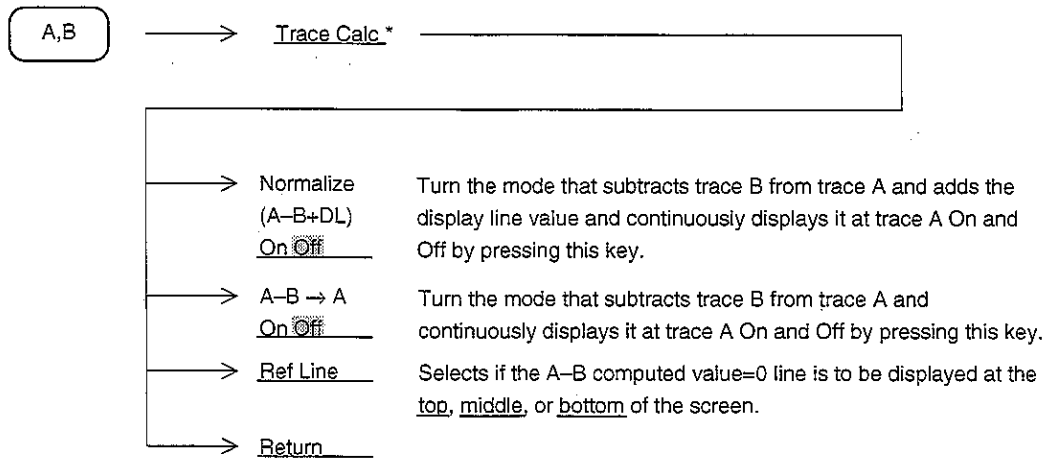

## Trace A and Trace B Overwrite Display

Overwrites trace A and trace B on one screen. At this time, the trace B frequency range, reference level, and other parameters are the same as trace A.

However, in the threshold mode and detection mode, the parameters can be set independently at trace A and trace B. For instance, comparison measurement with a standard waveform and simultaneous observation of the same waveform in a mode different from the normal mode and max hold (or averaging, etc.) mode are possible.

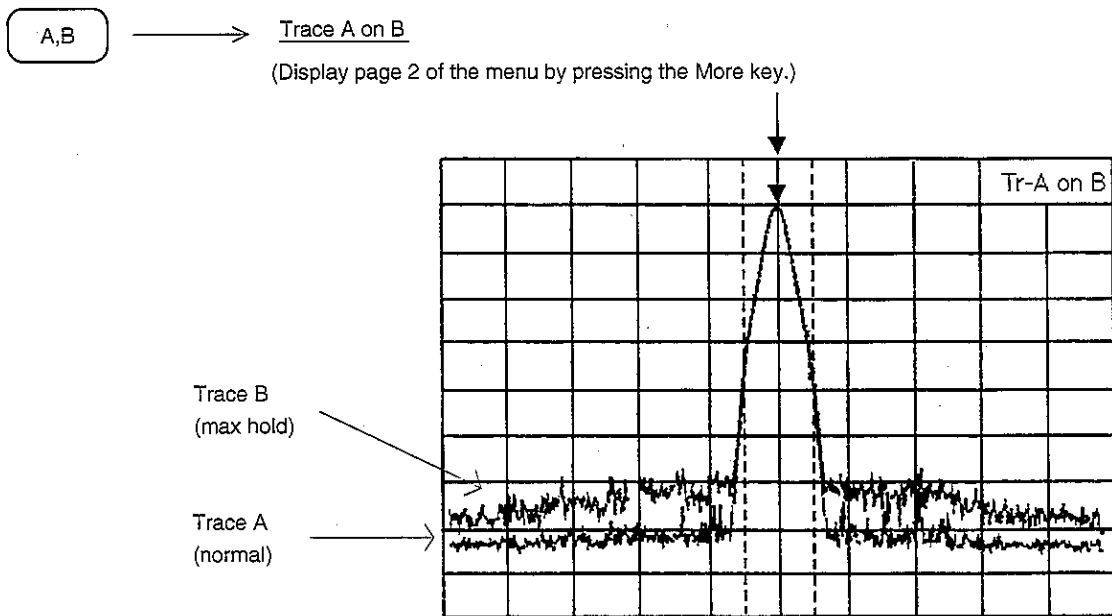

## Setting Active Trace

When trace A and trace B were overwritten on the same screen, select the marker trace by pressing this key.

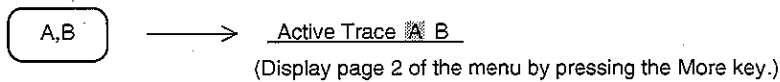

## Trace A/Trace B Top and Bottom Split Display

When trace A and trace B are overwritten and displayed, the setup parameters are common. In this mode, however, the frequency, reference level, and other parameters can be set independently.

For instance, the reference wave can be observed at trace A and harmonics can be simultaneously observed at trace B.

When examining interference, the frequency that is the source of the interference and interference of a different frequency that is generated by the effect of the source frequency can be simultaneously observed.

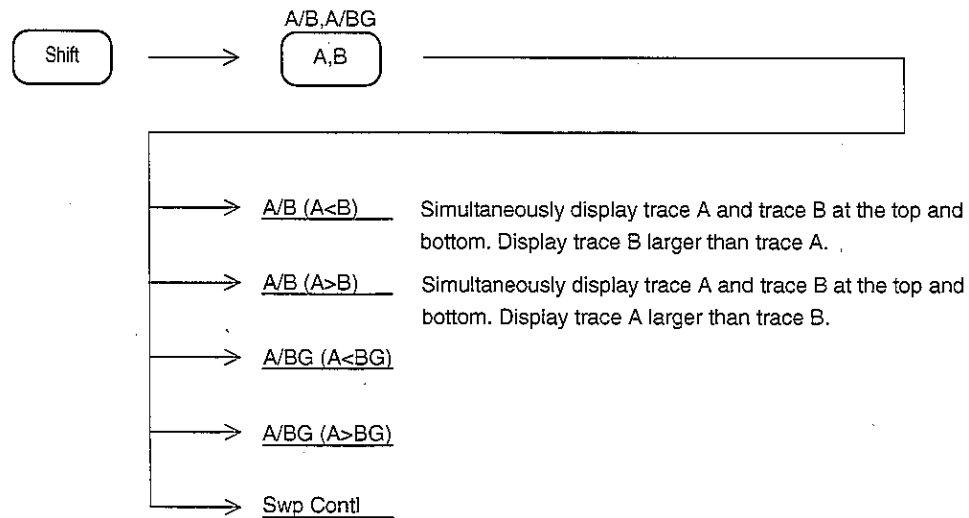

- The large display is called the main trace and the small display is called the sub-trace.

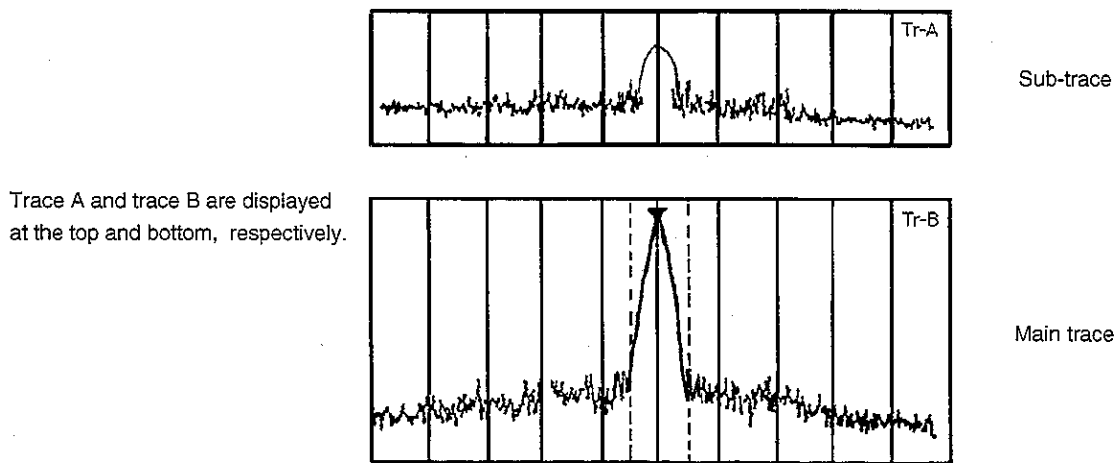

Trace A and trace B are displayed at the top and bottom, respectively.

For A/B (A<B)

## Setting Sub-trace Sweep

To set the sub-trace storage mode, perform the following key operations.

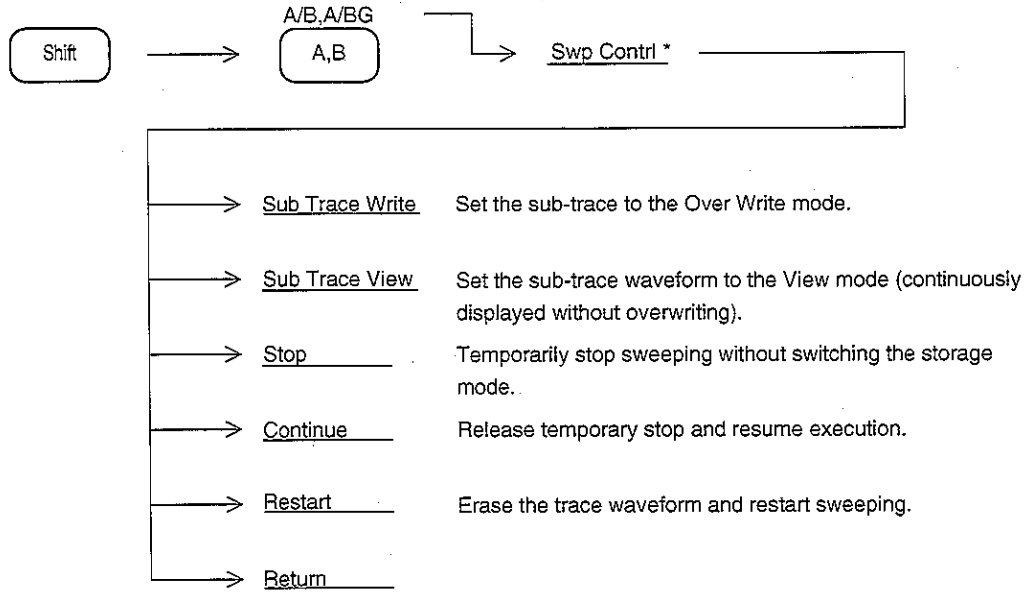

# Trace A/Trace BG Top and Bottom Split Display

This mode simultaneously displays trace A and trace BG. It is used to extract a specific signal from a wide frequency range.  
 The conditions over a wide surrounding frequency range can be monitored while simultaneously observing the selected signal in detail.

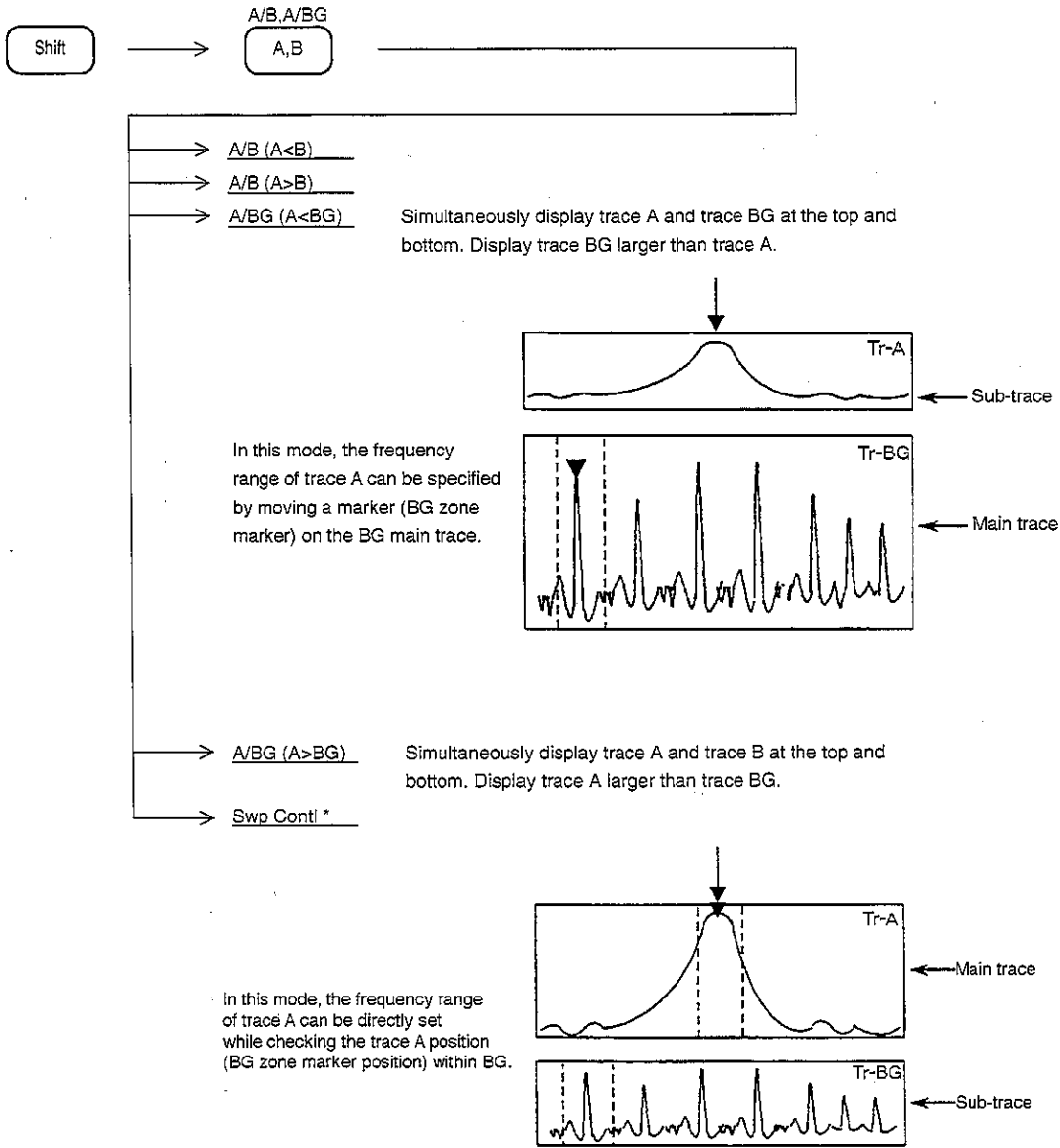

Trace A and trace BG parameters other than reference level, vertical axis scale, and input attenuator settings are used independently. Each parameter can be set in the main trace (larger displayed side).  
 Marker operation is available only for the main trace.

# Trace Time

Trace Time displays the time axis waveform at the center frequency of trace A or trace B. To display trace Time, press the **Time** key.

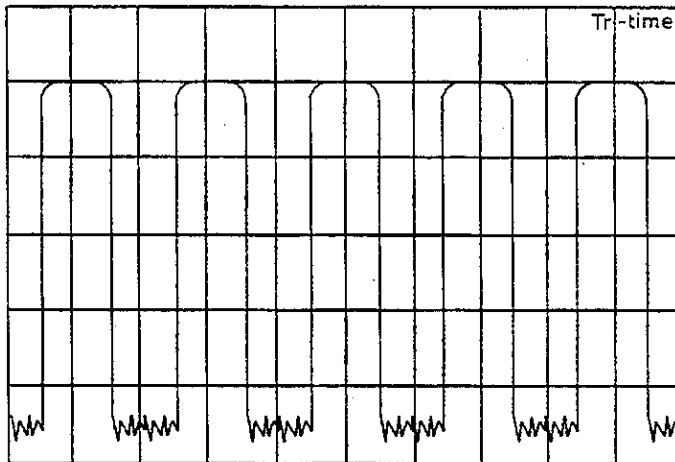

- |  |   |  |  |
|--|---|--|--|
| <div style="border: 1px solid black; border-radius: 10px; padding: 2px 5px; display: inline-block;">Time</div> | → | Delay Time<br><u>10.0 ms</u>   | Sets the delay time from trigger to sweep. When a negative value is input, the waveform before the trigger is displayed up to one screen. (See paragraph 6.12 of CHAPTER 6.) |
|  | → | Time Span<br><u>200 us</u>   | Sets the time span (time domain sweep time).   |
|  | → | Trigger<br><span style="border: 1px solid black; padding: 1px;">Freerun</span><br><u>Triggered</u> | Select freerun or trigger sweep by pressing this key.  |
|  | → | Trigger<br><u>Source *</u>   | Selects the trigger signal source.   |
|  | → | Storage *<br><u>          </u>   | Selects the storage display mode.  |
|  | → | Detection *<br><u>1</u>  | Selects the detection mode.  |
|  | → | FM Monitor *<br><u>          </u>  | Displays the FM demodulated waveform.  |
|  | → | Expand *<br><u>2</u>   | Expands and displays part of the time domain waveform.   |

(Display page 2 of the menu by pressing the More key.)



Trace-A center frequency and Trace-Time tuning frequency is always common. Other parameters can be set independently. However, the following parameters can be used commonly by "Coupled function common/independent setting mode" of Section 9.

- Resolution bandwidth (RBW)
- Video bandwidth (VBW)
- Sweep time (Sweep Time/Time Span)

# Trace A/Trace Time Top and Bottom Split Display

Trace A/Trace Time top and bottom split display simultaneously displays trace A and trace Time.

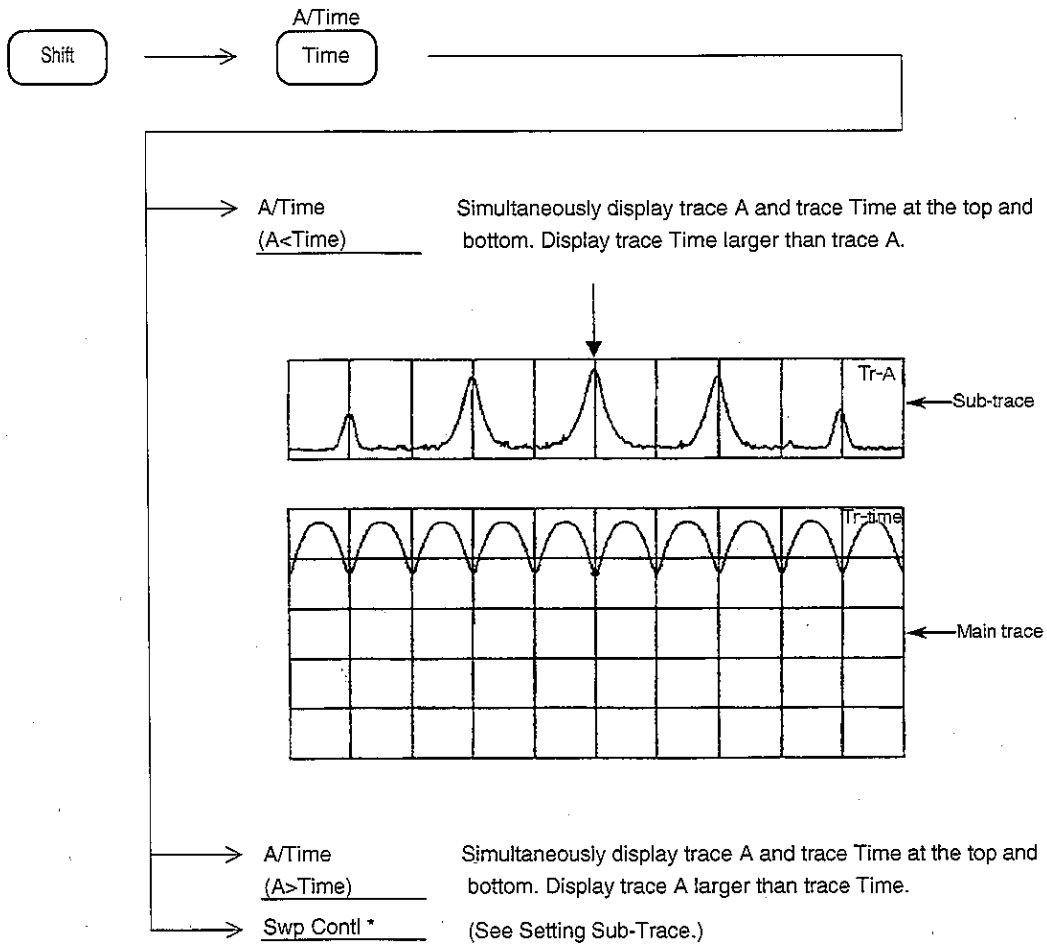

Each parameter can be set in the main trace (larger displayed trace). However, for common parameters (center frequency, reference level, input attenuator, and when system setting is coupled mode resolution bandwidth, video bandwidth, etc.), the sub-trace parameters can also be changed even when setting is performed at the main trace. Marker operation is only available for the main trace.

# Storage Mode

The following seven storage modes can be selected for Display modes trace A, trace B, and trace Time.

Types of Trace Modes (1/2)

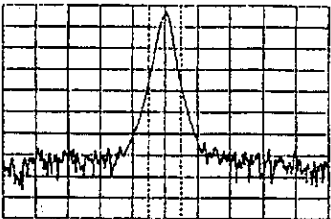
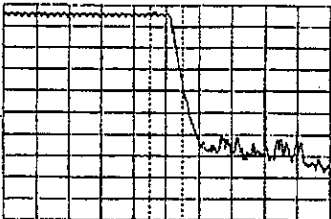
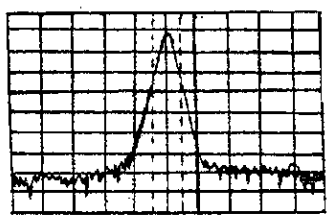
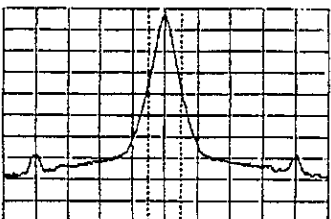
NO.	Mode	Explanation	Display example
1	Normal	Refreshes and displays the trace data at each sweep. This is used for normal measurement.	
2	Max Hold	At each sweep, compares the new trace data with the old data at each X axis point, then displays the larger value data. It is used to record a frequency-drifting signal.	
3	Min Hold	At each sweep, compares the new trace data with the old data at each X axis point, then displays the smaller value data.	
4	Average	At each sweep, calculates the average data at each X axis point, then displays the averaged results. This mode is used to improve the S/N ratio. For further details on the averaging function, see page 5-18.	

SECTION 5 SELECTING THE DISPLAY METHOD

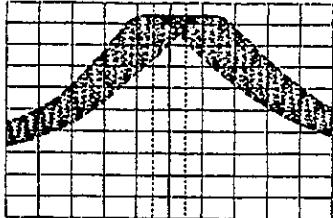
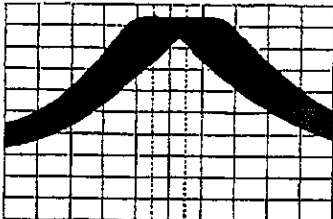
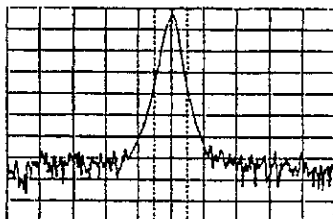
NO.	Mode	Explanation	Display example
5	Cumulative	Displays the cumulative waveform at each sweep. The waveform data, which are not connected by lines, are displayed by plotting the data.	
6	Over write	Displays the waveform overwritten without deleting the old trace data.	
7	View	Continues displaying the waveform as it is, without refreshing the currently-displayed trace data. This mode is used to observe waveforms with the trace data stopped temporarily.	

# Setting Storage Mode

The storage mode can be selected by operating the function keys shown below while the spectrum analyzer is operating in the trace A, trace B, or trace Time mode.

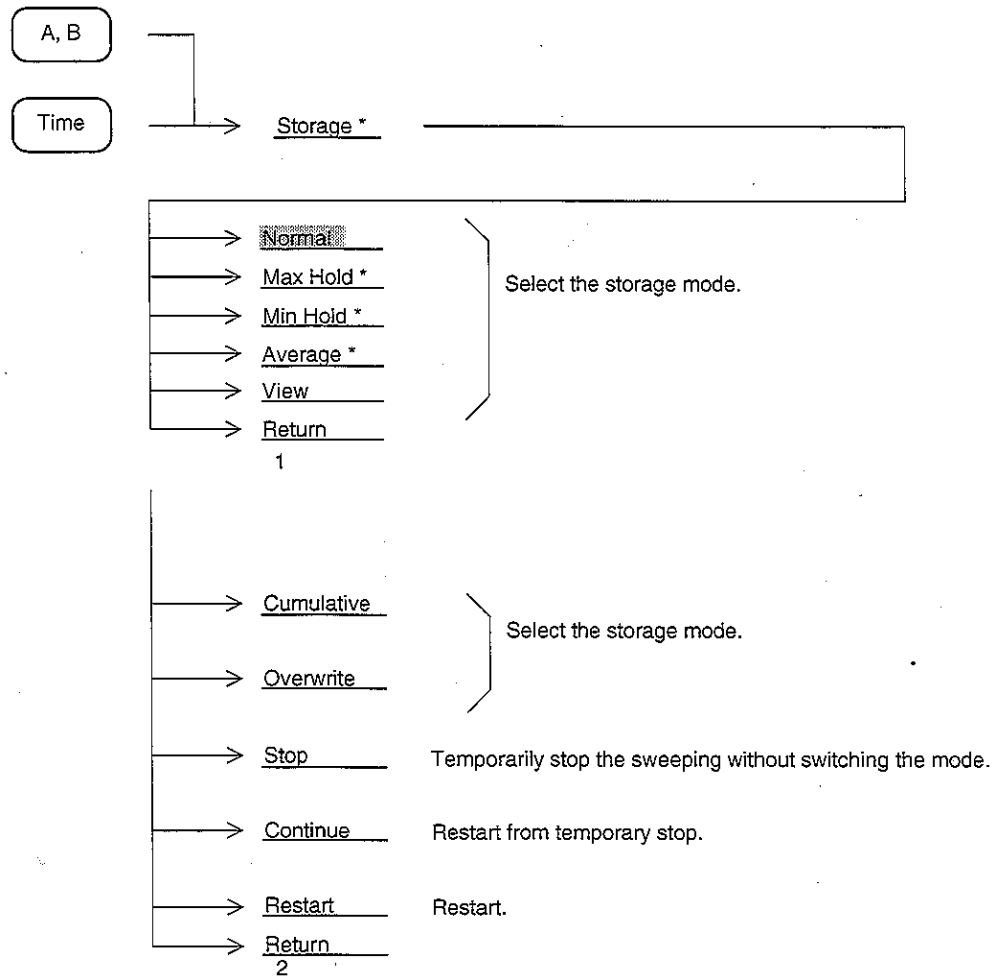

(Display page 2 of the menu by pressing the More key.)

## Averaging Function

The digital averaging function calculates the average data at each X axis point at each sweep and displays the results. It is executed by selecting Average in the trace A, trace B, and trace Time display modes.

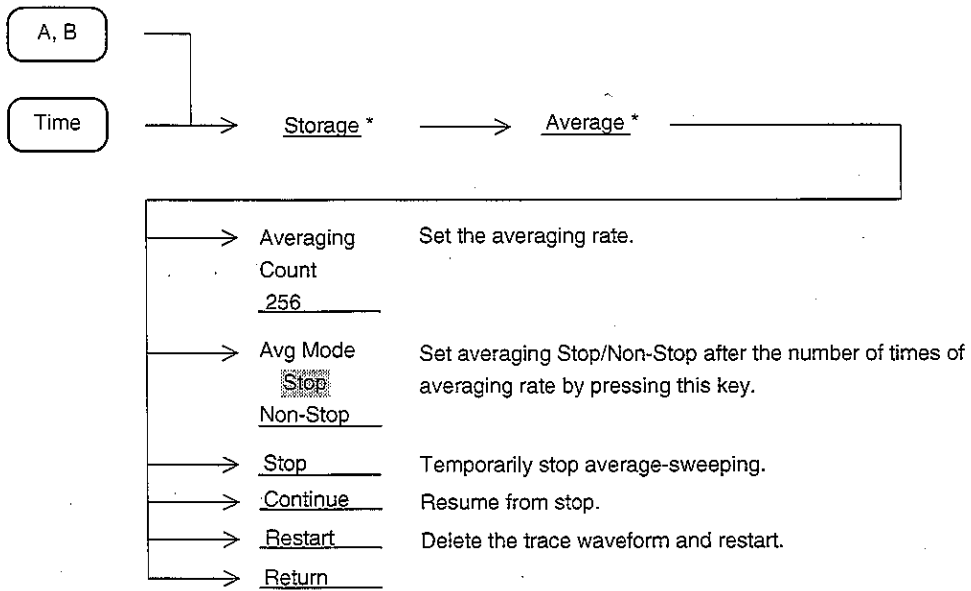

The averaging function improves the S/N ratio depending on the averaging rate and the number of sweep repetitions as shown on the next page.

Digital video averaging is performed by the method shown below.

## Averaging Rate = N

	NUMBER OF sweep repetitions	Measurement value	Displayed value
[3] Restart ↓	1	M (1)	$Y (1) = M (1)$
	2	M (2)	$Y (2) = Y (1) + \frac{M (2) - Y (1)}{2}$
	3	M (3)	$Y (3) = Y (2) + \frac{M (3) - Y (2)}{3}$
	⋮	⋮	⋮
	N-1	M (N-1)	$Y (N-1) = Y (N-2) + \frac{M (N-1) - Y (N-2)}{N-1}$
[1] Stop ↓	N	M (N)	$Y (N) = Y (N-1) + \frac{M (N) - Y (N-1)}{N}$
[2] Continue ↓	N + 1	M (N+1)	$Y (N+1) = Y (N) + \frac{M (N+1) - Y (N)}{N}$
	N + 2	M (N+2)	$Y (N+2) = Y (N+1) + \frac{M (N+2) - Y (N+1)}{N}$
	⋮	⋮	⋮

[1] Sweep stops after N repetitions. (When Avg Mode is Stop)

[2] The above stop condition is released by restarting sweep by Continue. The averaging operation resumes, while counting the number of sweep repetitions as N+1, N+2....

[3] When Restart is performed during sweep or Stop, averaging is repeated from sweep count 1.

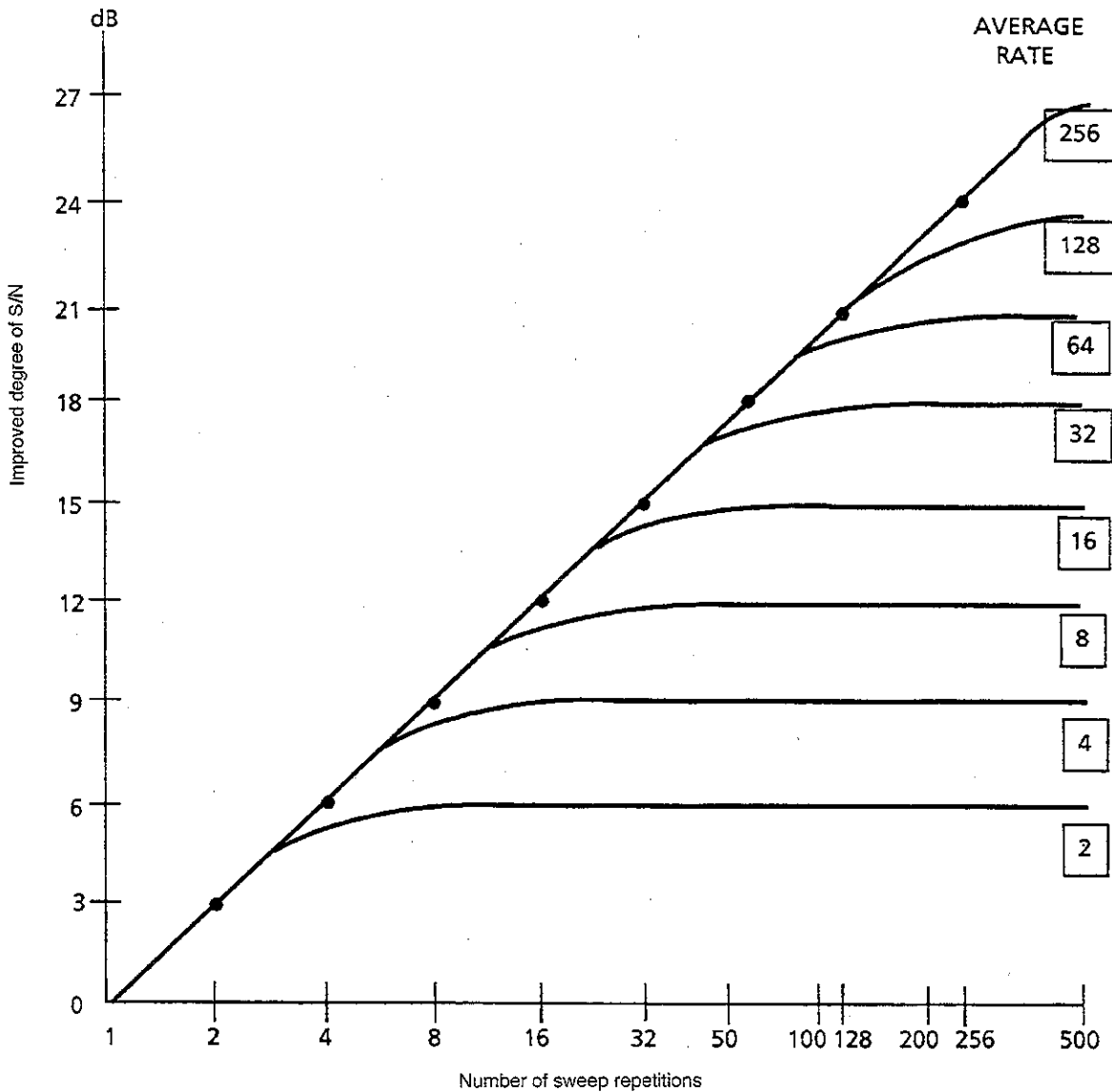

S/N Improvement by Digital Video Averaging

Averaging by video filter has the disadvantage that the sweep time becomes longer when the video bandwidth is narrowed to improve the averaging effect.

On the other hand, digital video averaging smoothes the trace display by averaging the digital data after A/D conversion at each sweep, without narrowing the video bandwidth (VBW). Since the video bandwidth (VBW) gets comparatively wider and the time required for each sweep can be shortened, the entire spectrum image can be verified quickly and the repetitive sweep can be stopped when the required smoothing has been obtained. The problem of averaging with the video filter is that the time required for each sweep becomes longer and it takes a long time to verify the entire spectrum image.

Since the averaging rate is initially eight, the above figure shows that an S/N improvement of 9 dB is obtained with eight sweeps.



# Max Hold and Min Hold Functions

When Max Hold or Min Hold is selected, the sweeping can be performed by the number of specified repetitions, and then stops.

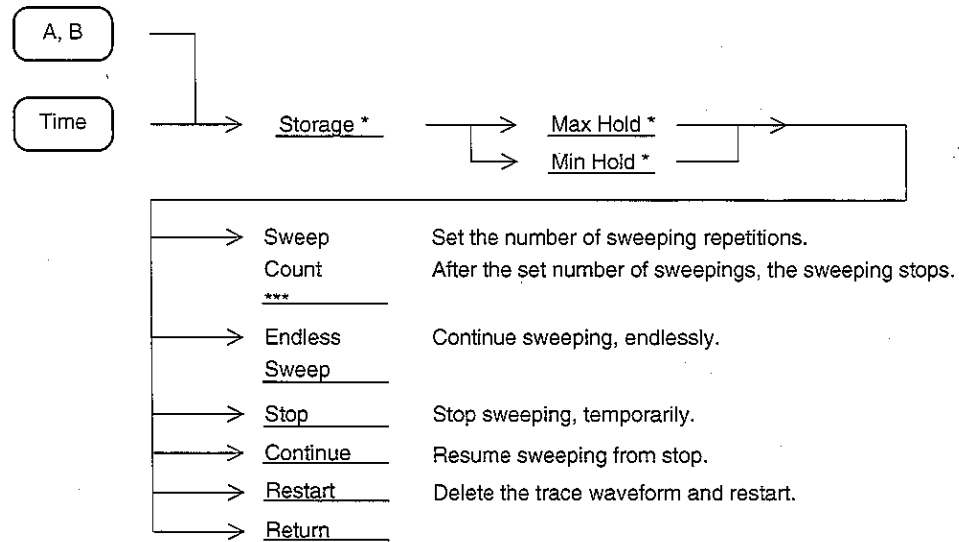

## Detection Mode

The detection mode can be selected from among Normal, Pos Peak, Sample, and Neg Peak for trace A and trace B.

Normal	Traces the maximum value and minimum value between sample points.
Pos Peak	Traces the maximum value between sample points.
Sample	Traces the instantaneous value between sample points.
Neg Peak	Traces the minimum value between sample points.

However, trace BG is fixed at Pos Peak.

When the time span is under 20 ms at trace Time, only Sample is available.

# Selecting Detection Mode

Select the detection mode for trace A, trace B, or trace Time by performing the following key operations.

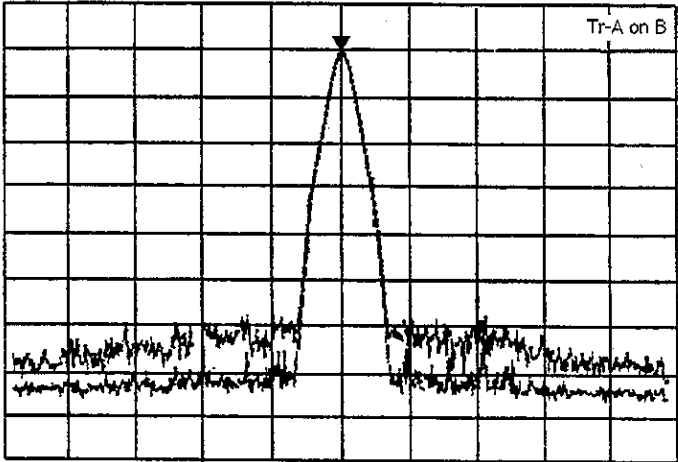
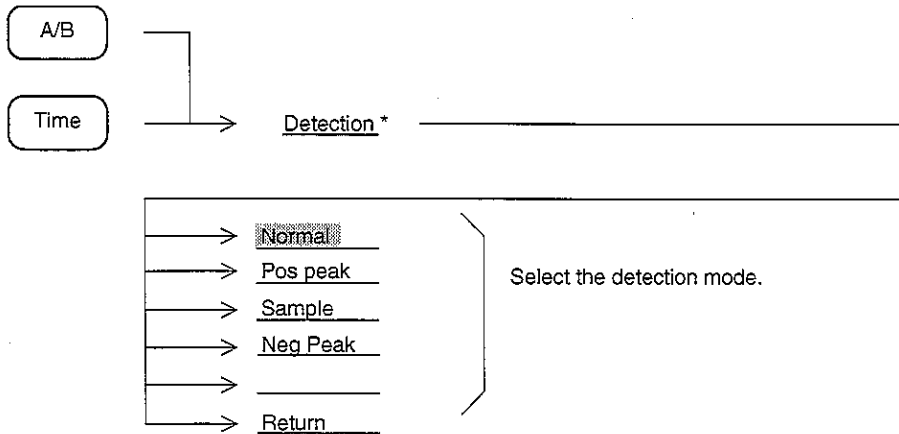

Waveforms when trace A is in the Pos Peak mode and trace B is in the NegPeak mode

## Selecting Measured Level by Detection Mode

The spectrum analyzer has 501 horizontal-axis measurement sample points. This corresponds to 501 storage trace memories.

The detection mode determines what type of measured value should be stored in the trace memory at each measurement sample point.

Detection mode	Description
Normal	Stores both the maximum level and the minimum level present between the current sample point and the next sample point and displays them on the screen. This mode is used in normal measurement.
Pos Peak	Holds the maximum level present between the current sample point and the next sample point, then stores the maximum value in the trace memory corresponding to the current sample point. Pos Peak is used to measure the peak value of signals near the noise level.
Sample	Stores the instantaneous signal level at each sample point to the trace memory. Sample is used for noise level measurement, time domain measurement, and other measurements.
Neg Peak	Holds the minimum level present between the current sample point and the next sample point, then stores the minimum value to the trace memory corresponding to the current sample point. The Neg Peak mode is used to measure the lower envelope side of a modulated waveform.

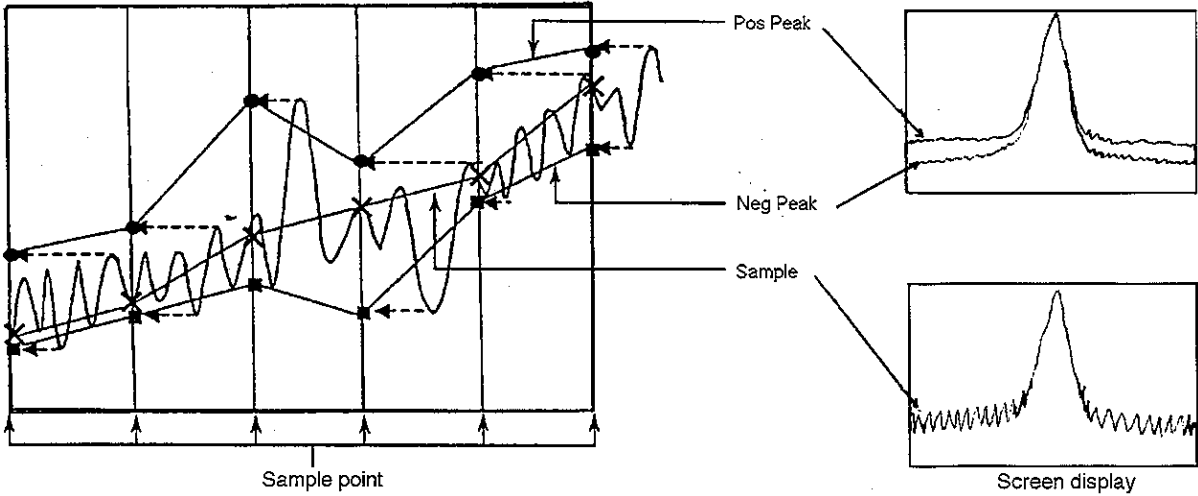

Note: When the detection mode is set to Sample or Neg Peak while the frequency span and resolution bandwidth are set so that the spectrum is displayed as discrete vertical lines, the spectrum peak is incorrectly displayed.

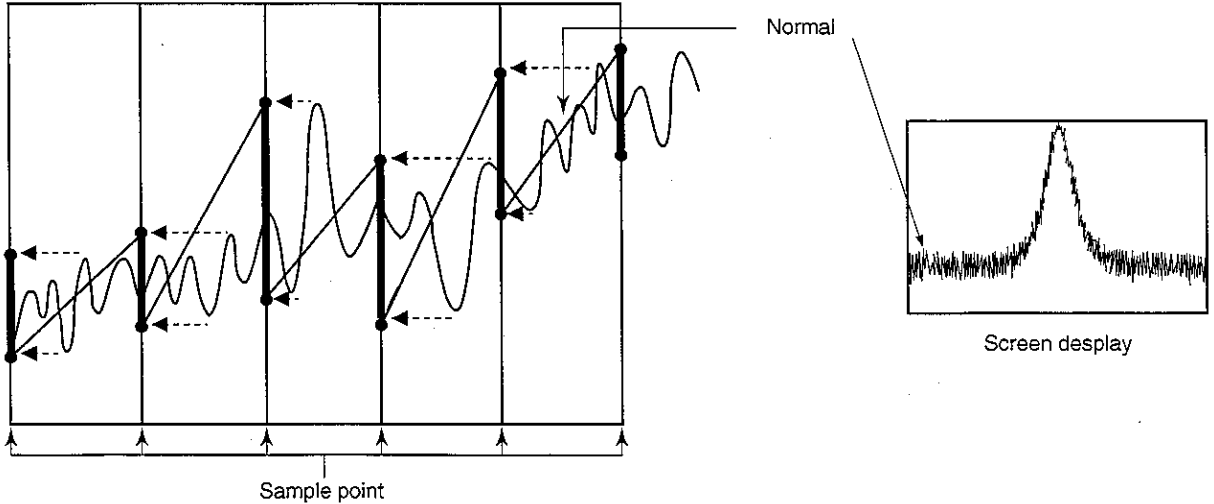

Normal traces and displays both Pos Peak and Neg Peak.

# Time Domain

Since the spectrum analyzer stops sweeping the frequency when set to a frequency span of 0 Hz, the spectrum analyzer becomes a selective level meter that continues to receive only the center frequency. In this case, the horizontal axis of the time-axis sweep waveform is graduated in time and displayed on the spectrum analyzer screen. This display method is called "time domain display".

The spectrum analyzer time domain display has an Expand function for expanding the waveform time axis to create a more convenient display. It also has a special function for monitoring an FM demodulated waveform.

## Setting Time Domain

The time domain can normally be set by pressing the **Time** key in the Display section. It can also be set by setting the frequency span to 0 Hz in the frequency domain mode.

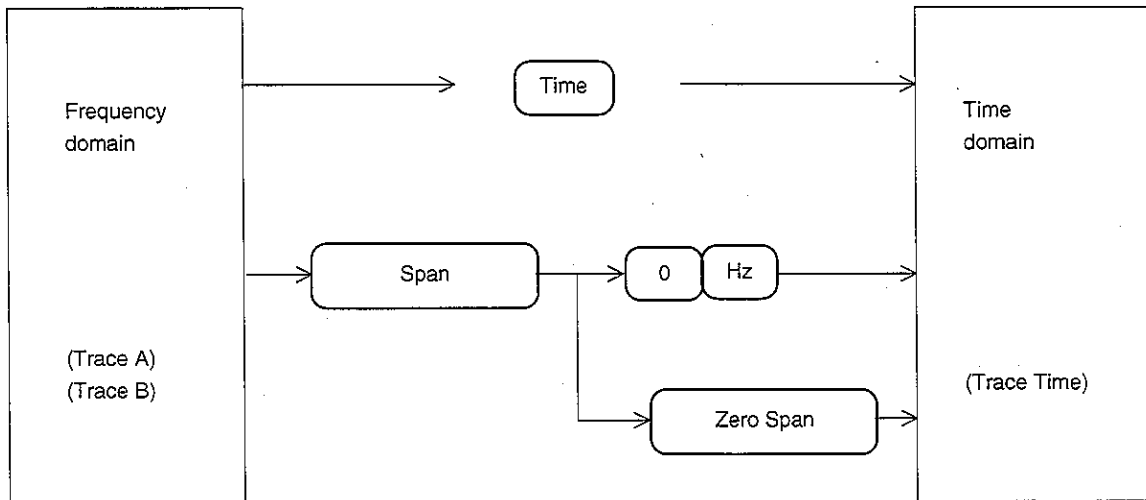

The following parameters can be set independently in the frequency domain or time domain mode.

- Vertical scale mode (Log/Lin)
- Vertical scale range (10 dB/div, 10%/div, etc.)
- Storage mode (Normal, Max Hold, Average, etc.)
- Detection mode (Pos Peak, Sample, Neg Peak, Normal)
- Resolution bandwidth (RBW)
- Video bandwidth (VBW)
- Sweep time (Sweep Time/Time Span)
- Trigger switch (Freerun/Triggered)

The three parameters resolution bandwidth, video bandwidth, and sweep time can be selected in common or independently in the frequency domain or time domain mode when setting the system.

Note: The time domain mode marker function uses a spot marker. A zone marker cannot be used.

## Setting Time Span

In the time domain mode, the measurement range on the horizontal axis does not set the frequency span, but sets the time span. To set the time span, perform the following key operations.

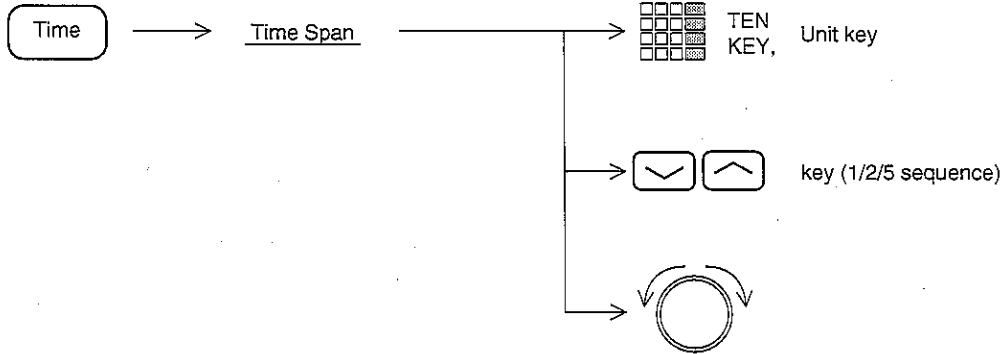

# Time Domain Expanded Display

Part of the time domain time axis can be expanded and displayed.

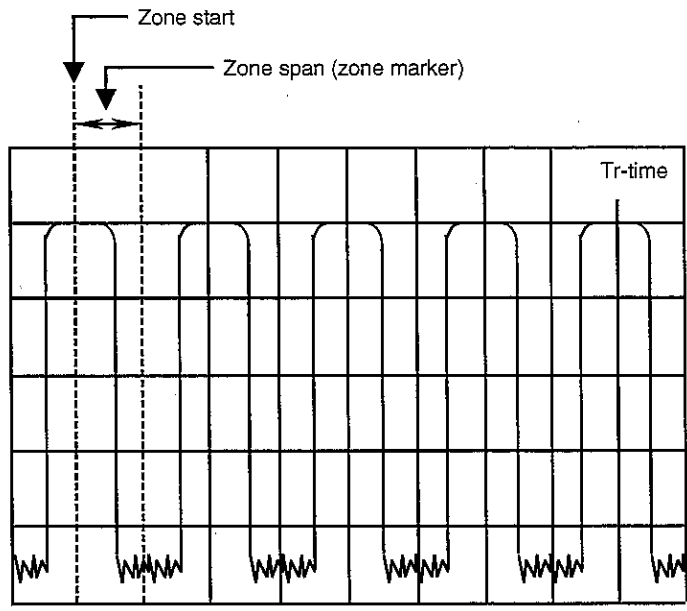
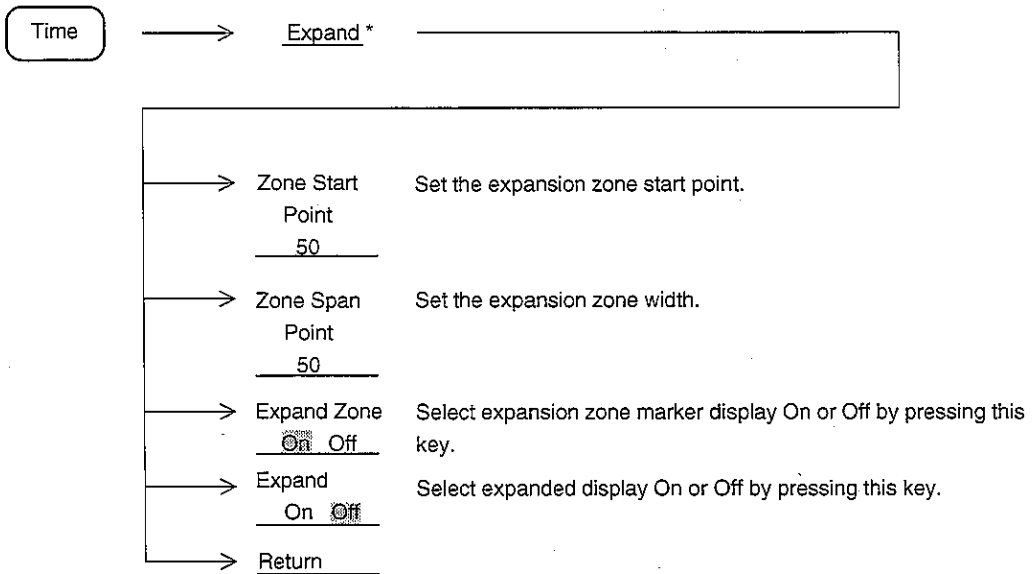



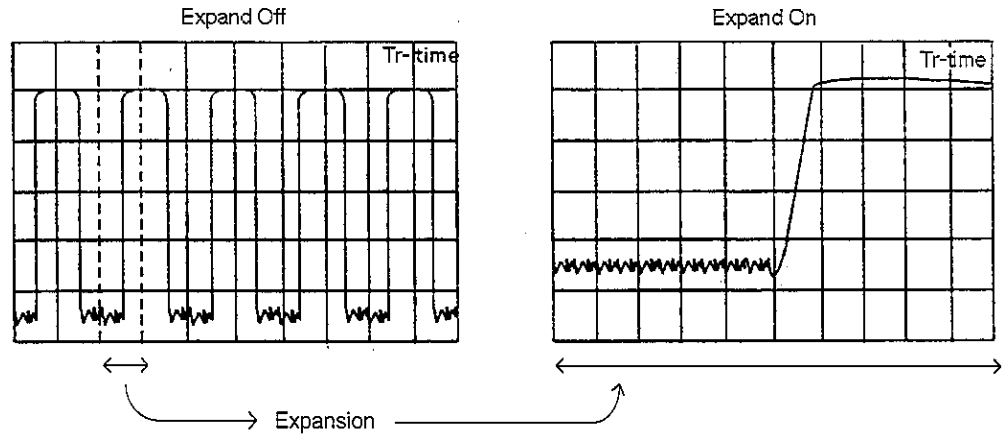

The Expand mode cannot be executed under the following conditions.

- Trigger mode ..... Freerun

# Monitoring FM Demodulated Waveforms

The spectrum analyzer contains an FM demodulator to display demodulated waveforms.

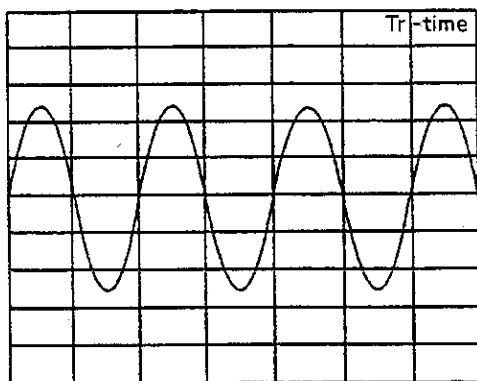
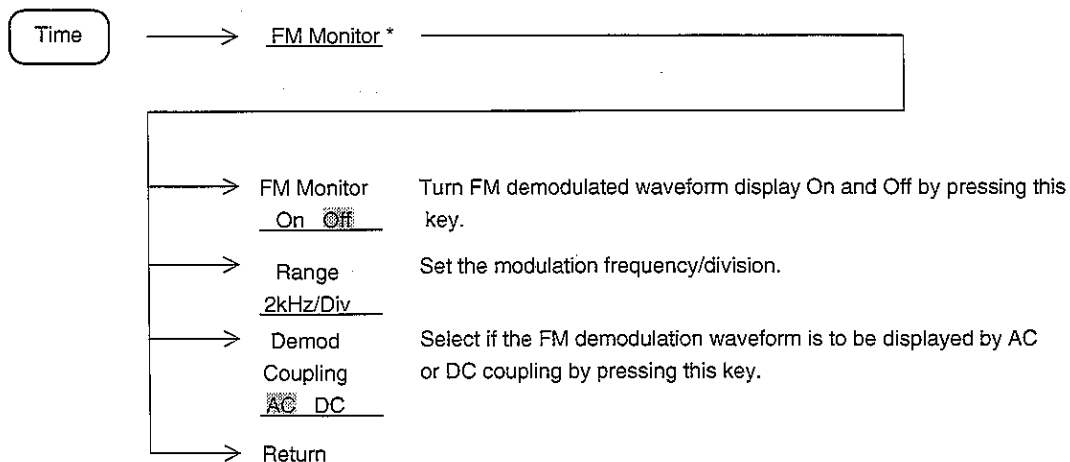

By using the FM demodulated waveform monitor function, frequency deviation can be easily measured.

To monitor an FM demodulated waveform, set the resolution bandwidth and video bandwidth as follows:

- Resolution bandwidth (RBW) ..... When a signal not accompanied by an interference wave has been received, the resolution bandwidth should be made as wide as possible. If it is necessary to narrow the resolution bandwidth, the bandwidth should be made more than three times (frequency deviation + modulation frequency). Too narrow a resolution bandwidth results in a distorted modulation waveform.
- Video bandwidth (VBW) ..... The video bandwidth should be made as narrow as possible although a bandwidth of more than ten times the modulation frequency is required. Setting a wide video bandwidth will degrade the S/N ratio. If it is necessary to set a wide bandwidth, digital averaging can be used to improve the S/N ratio.

Note: • Because the demodulation frequency range depends on the FM demodulation range, if the FM demodulation range is switched to an FM signal with a high demodulation frequency, a different waveform will be observed.

The following shows the demodulation frequency range corresponding to the respective FM demodulation ranges.

50, 100, 200 kHz/div range	DC or 50 Hz to 500 kHz
2, 5, 10, 20 kHz/div range	DC or 50 Hz to 50 kHz

- Usable RBW are:  $RBW \geq 1 \text{ kHz}$



## SECTION 6

### SELECTING THE SWEEP METHOD

This section describes the sweep mode, trigger sweep mode, zone sweep, and signal tracking and time gate functions.

#### TABLE OF CONTENTS

Sweep Mode .....	6-3
Continuous Sweep Mode .....	6-3
Single Sweep Mode .....	6-4
Trigger Mode .....	6-5
Freerun .....	6-5
Triggered .....	6-6
Video Trigger .....	6-7
Wide IF Video Trigger .....	6-8
External Trigger .....	6-8
Line Trigger .....	6-10
Delay Time .....	6-10
Zone Sweep and Signal Tracking .....	6-12
Zone Sweep .....	6-12
Signal Tracking .....	6-13
Time Gate Function .....	6-14
Creating a Gate Control Signal .....	6-17
Setting Gate Function .....	6-18
Domain Sweep .....	6-22
Using Domain Sweep .....	6-22



# SECTION 6 SELECTING THE SWEEP METHOD

## Sweep Mode

The spectrum analyzer sweep mode is set by using the following key.

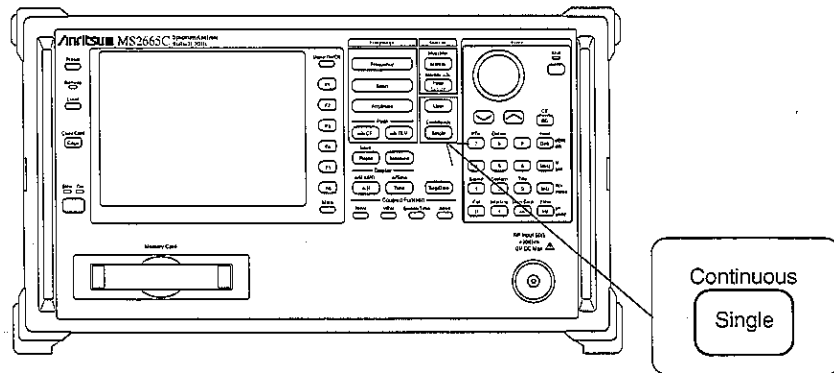

## Continuous Sweep Mode

When the trigger mode is set to Freerun, sweep is performed continuously. When the trigger mode is set to Triggered, sweep is executed each time the trigger conditions are met.

To set the continuous sweep mode, perform the following key operation. (The continuous sweep mode is initially set.)

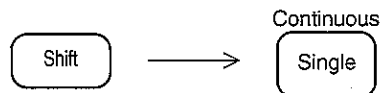

## Single Sweep Mode

When the trigger mode is set to Freerun, sweep is executed once immediately after the <sup>Continuous</sup> Single key is pressed.

When the trigger mode is set to Triggered, sweep is executed only once when the trigger conditions are met after the <sup>Continuous</sup> Single key is pressed.

To set (sweep start) the single sweep mode, operate the following key.

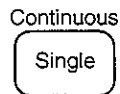



# Trigger Mode

The spectrum analyzer trigger mode can be divided into Freerun and Triggered.  
In the Triggered mode, Video, Wide IF Video, External, or Line can be selected as the trigger source.  
To use the Trigger mode, Option 06 Trigger/gate circuit is required.

# Freerun

When the sweep mode is set to continuous, sweep is repeated continuously. When the sweep mode is set to single sweep, sweep is started immediately after the <sup>Continuous</sup> Single key is pressed.

To set the Freerun mode, perform the following key operations. (The Freerun mode is initially set.)

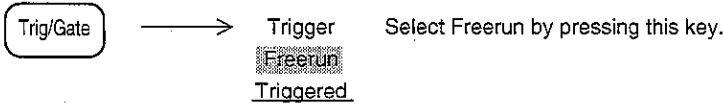

# Triggered

When the conditions of the pre-selected trigger source are met, sweep is started.

To set the Triggered mode and to select the trigger source, perform the following key operations.

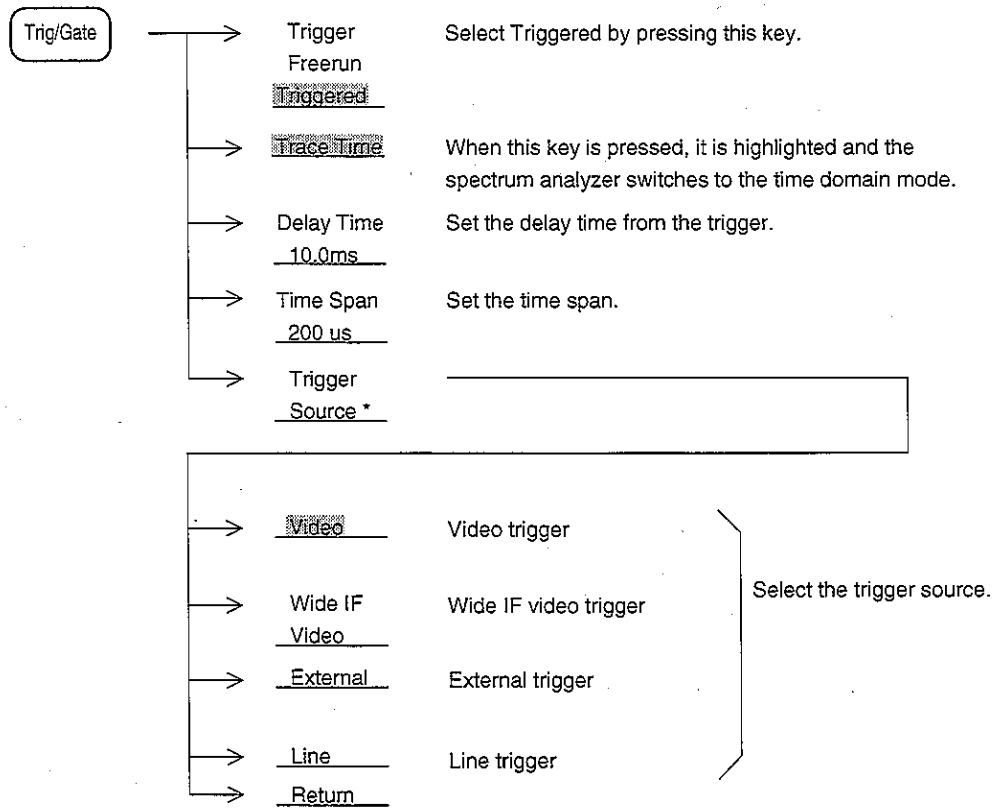

# Video Trigger

Sweep is started in synchronization with the positive leading edge or negative leading edge of the detected waveform.

To select the trigger level and trigger slope, perform the following key operations.

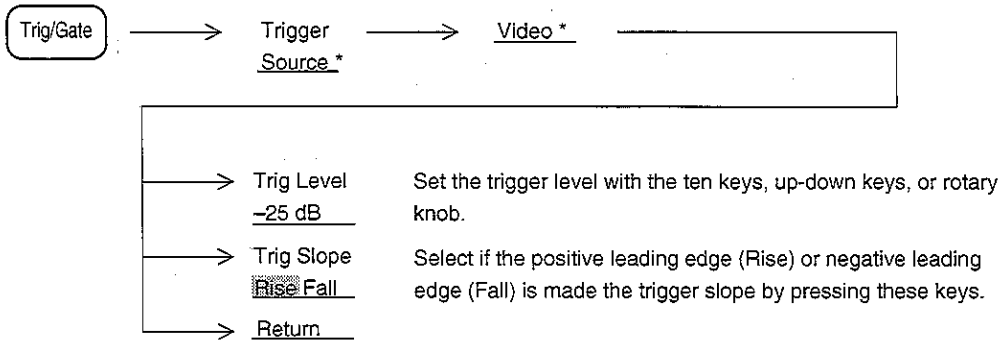

The trigger level is indicated by displaying the trigger level indicator ► at the leftmost vertical line of the screen.

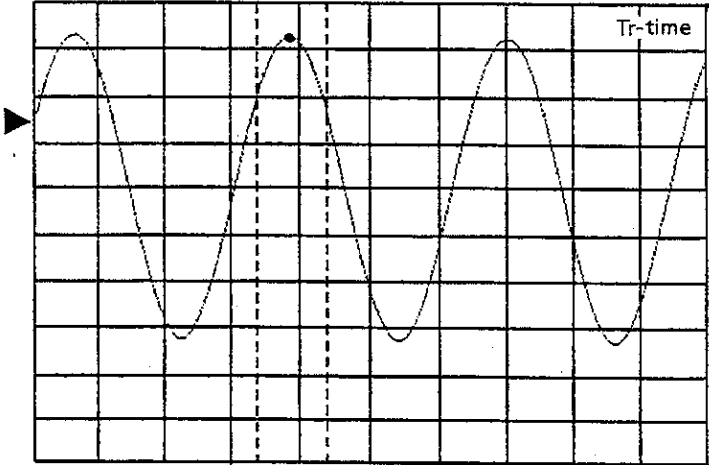

## Wide IF Video Trigger

A wide bandwidth IF signal of at least 5 MHz is detected and sweep is started in synchronization with its positive leading edge or negative leading edge.

To select the trigger level and trigger slope, perform the following key operations.

Generally, there is no burst synchronizing signal and this signal is used as a burst wave gate control signal.

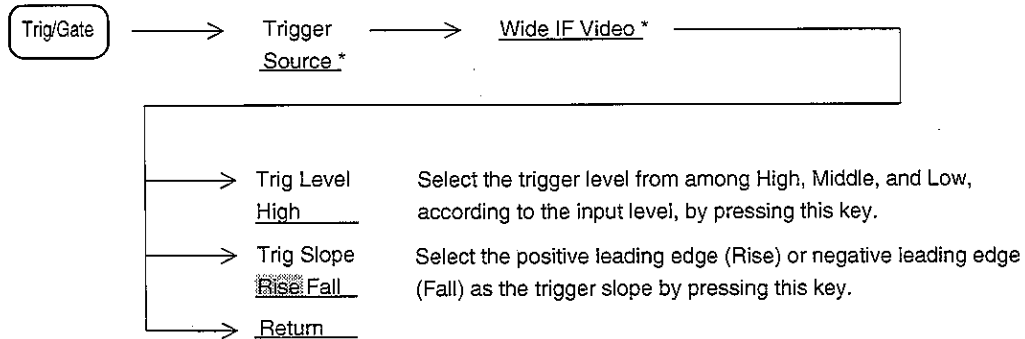

An indicator of appropriate trigger levels for Wide IF Video is listed below.

Trig Level	Mixer level*
High	-10 dBm(nominal)
Middle	-20 dBm(nominal)
Low	-30 dBm(nominal)

\* This designed at 100 MHz.

Actual trig level is dependent of frequency of input.

Mixer level is "actual input of RF input" - " RF attenuator value ", if the instrument has no preamplifier option installed.

## External Trigger

Sweep is started in synchronization with the positive leading edge or negative leading edge of the signal waveform input to the Ext Input connector on the rear panel. To select the trigger level and trigger slope, perform the following key operations.

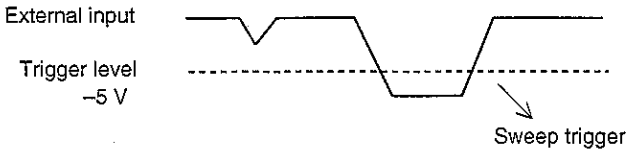
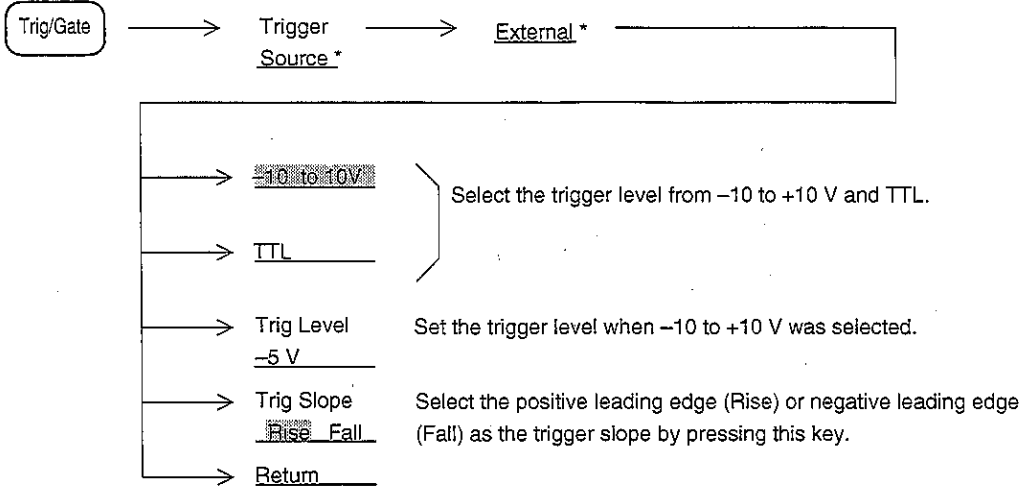

(Example) When trigger level is -5 V and trigger slope is Rise

## Line Trigger

This function starts sweep in synchronization with the AC power line frequency. Line trigger is conveniently used to observe power line-related hum waveform. With the line trigger function, the trigger level and trigger slope are not selected.

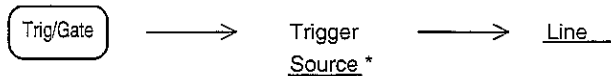

## Delay Time

When the trigger mode is set to Triggered in the time domain mode, the trigger point is usually positioned at the left end of the screen. This, however, means that it is not possible to see the waveform before the trigger point and the waveform beyond the right end of the screen.

With the spectrum analyzer, a waveform away from the trigger point can be displayed by changing the delay time.

To set the delay time, perform the following key operations.

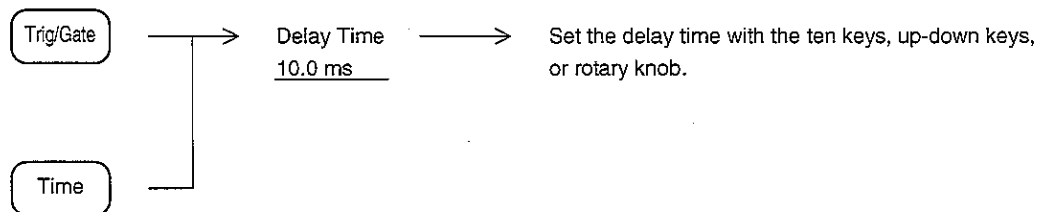

If the trigger point on the time axis on the screen was set by delay time, the trigger level indicator ► is displayed at the bottom of the screen.

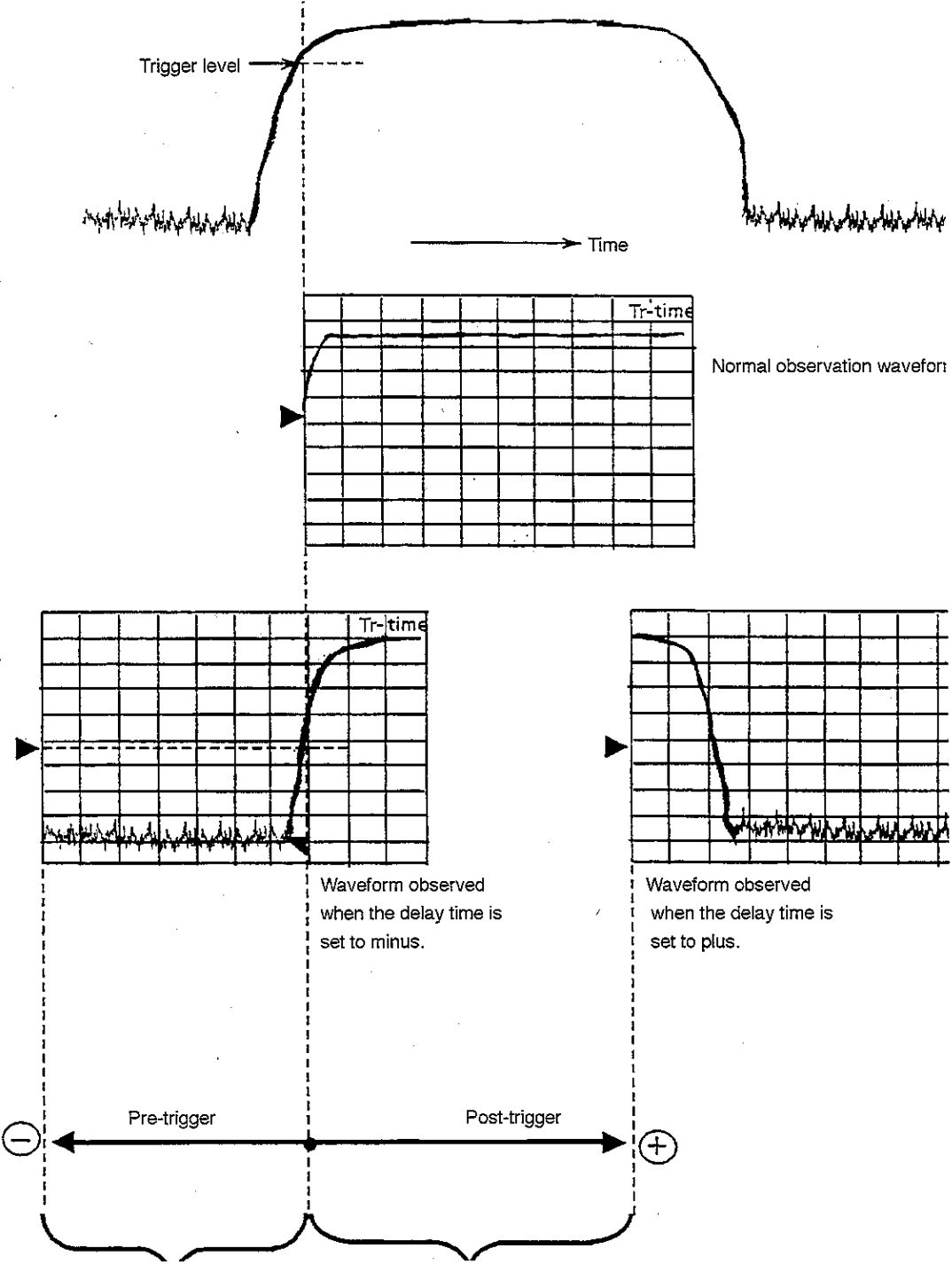

Example of Waveform With Delay Time (when used with video trigger)

## Zone Sweep and Signal Tracking

The spectrum analyzer has two sweep methods - zone sweep which sweeps only within the zone marker and a signal tracking function which detects the peak level frequency at each sweep, then moves it to the center of the zone marker.

### Zone Sweep

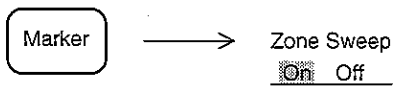

(Display page 2 of the menu by pressing the More key.)

Zone sweep can be conveniently used to closely and quickly analyze part of the whole sweep range on the screen.

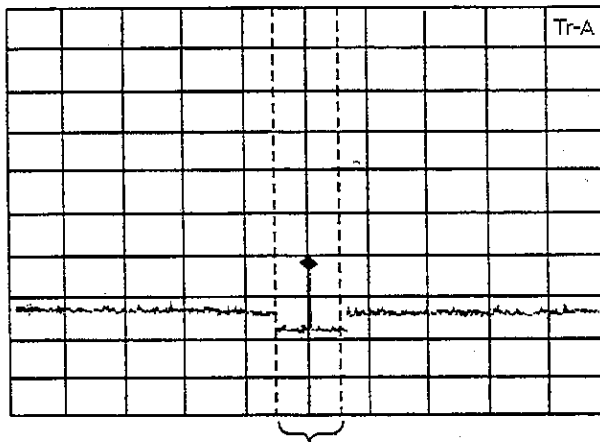

A signal masked by noise can be analyzed at high speed by setting zone sweep to On and adjusting the resolution bandwidth and video bandwidth.

Note: Zone sweep cannot be executed while the marker is Off or when the instrument is in the time domain mode.



When the multimarker function is on, Each multimarker in on state is sequentially zone-swept(multi-zone sweep).

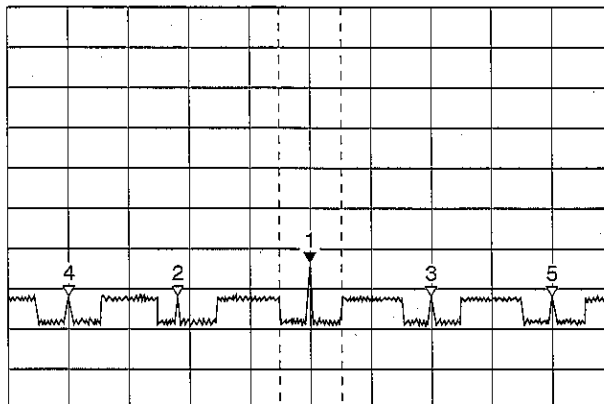

## Signal Tracking

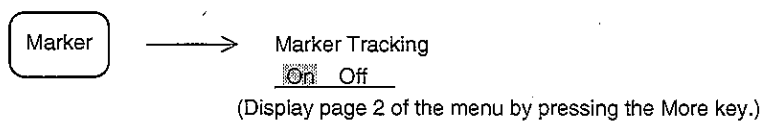

The signal tracking function moves the frequency of the signal of the peak level in the zone marker to the center of the zone marker at each sweep. This is convenient when tracking and analyzing a signal whose frequency drifts.

Note: The signal tracking function cannot be executed while the marker is Off or when the instrument is in the time domain mode.

## Time Gate Function

The time gate function is a sweep mode which turns the waveform data display On and Off by the gate control signal generated in the spectrum analyzer based on an external signal or video trigger signal.

Since the timing that displays the spectrum waveform can be set by using this mode, the spectrum when the burst signal is On can be analyzed.

In order to use the time gate function, an external trigger signal synchronized with burst wave On/Off or other signal change is required to create the gate control signal.

When an external synchronizing signal is unavailable, set the trigger source to wide IF video trigger. A synchronizing signal can be obtained internally.

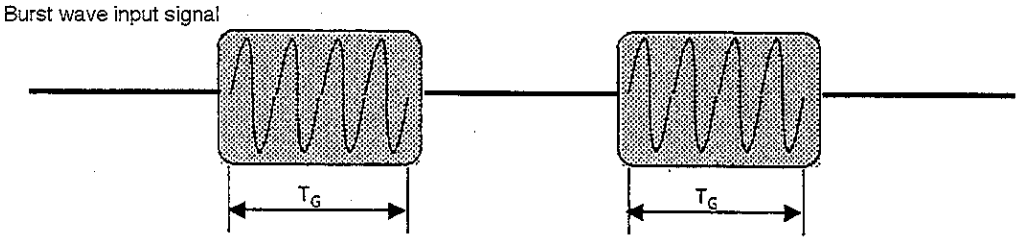

If the spectrum of the burst wave above is analyzed as it is,

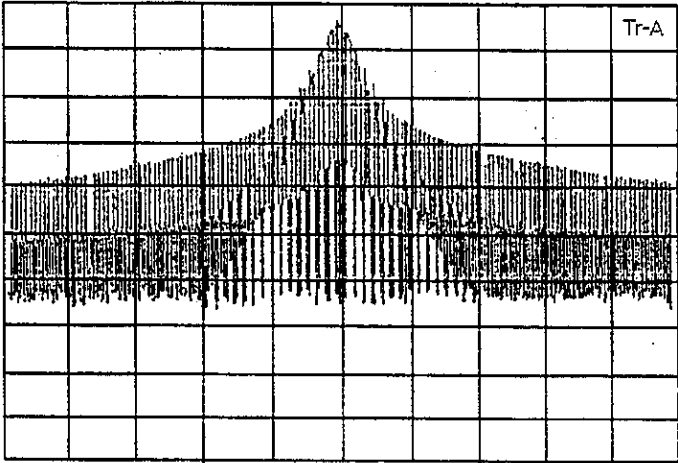

The spectrum spread by the positive leading edge or negative leading edge of the burst wave prevents the spectrum from being observed with the burst set to On.

If the spectrum can be analyzed only during the gate time  $T_G$ ,

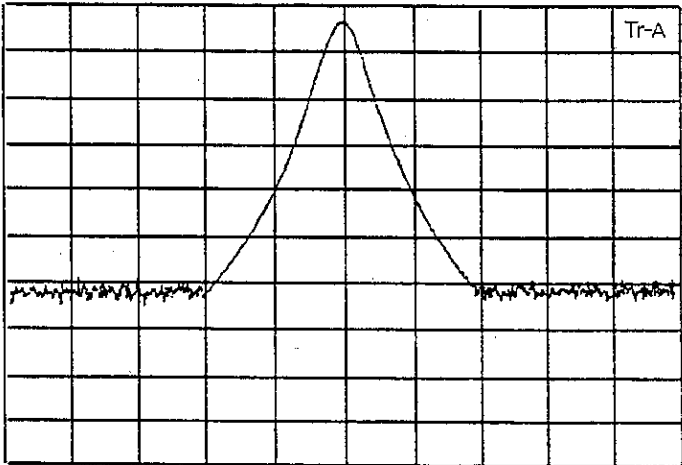

Only the spectrum when the burst is set to On is displayed.

SECTION 6 SELECTING THE SWEEP METHOD

When the time gate function is executed, sweep runs in the Freerun mode and only the waveform data validated by the gate control signal is refreshed. If the sweep period is not synchronized with the gate control signal, a perfectly shaped trace can be obtained by increasing the number of sweep repetitions.

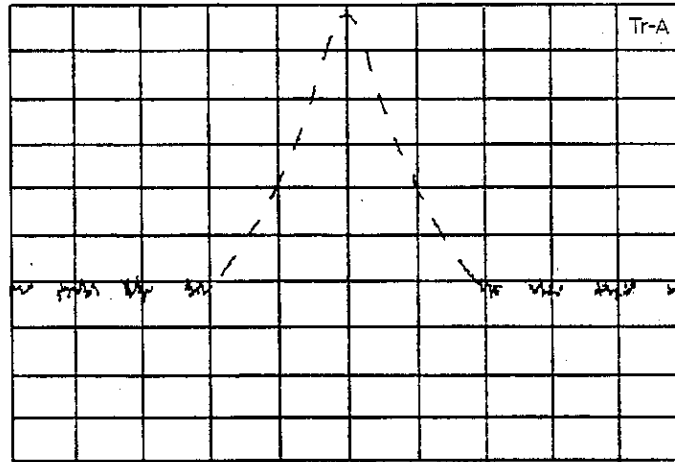

Fewer Sweep Repetitions

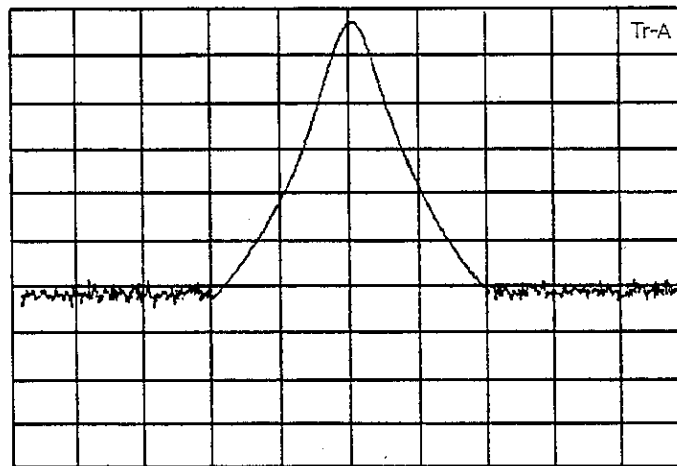

More Sweep Repetitions

Example of Frequency Spectrum Measurement on Burst Signal

# Creating a Gate Control Signal

If the point where an external trigger signal (Ext Input only) or a wide IF video trigger signal is triggered is assumed to be the reference position, the gate control signal remains On over the period from the point immediately after the Gate Delay time has elapsed from the reference position to the time set by Gate Length, or to the time reset by a trigger signal.

- Gate End: When Int selected

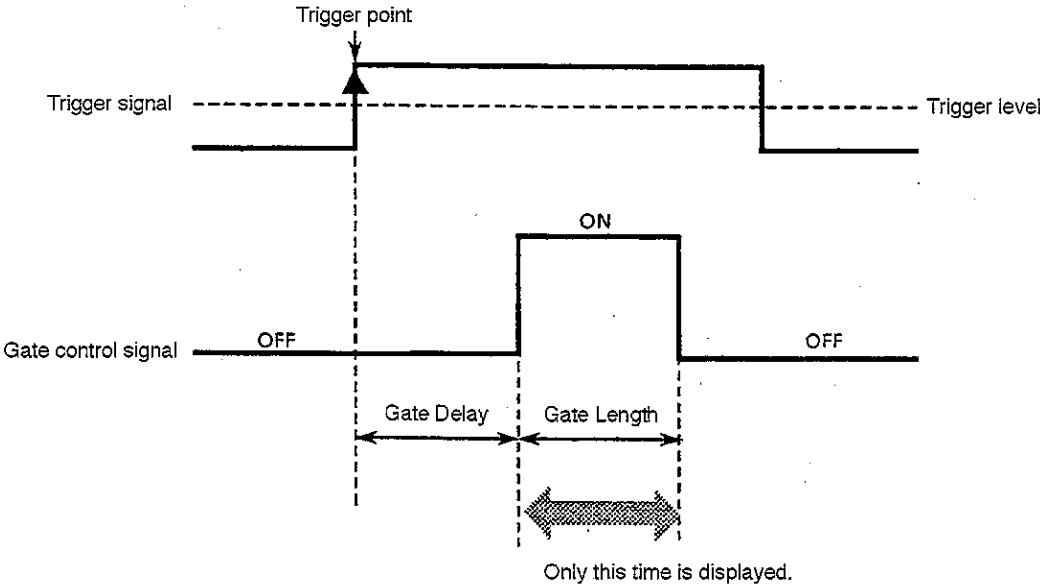

- Gate End: When Ext selected

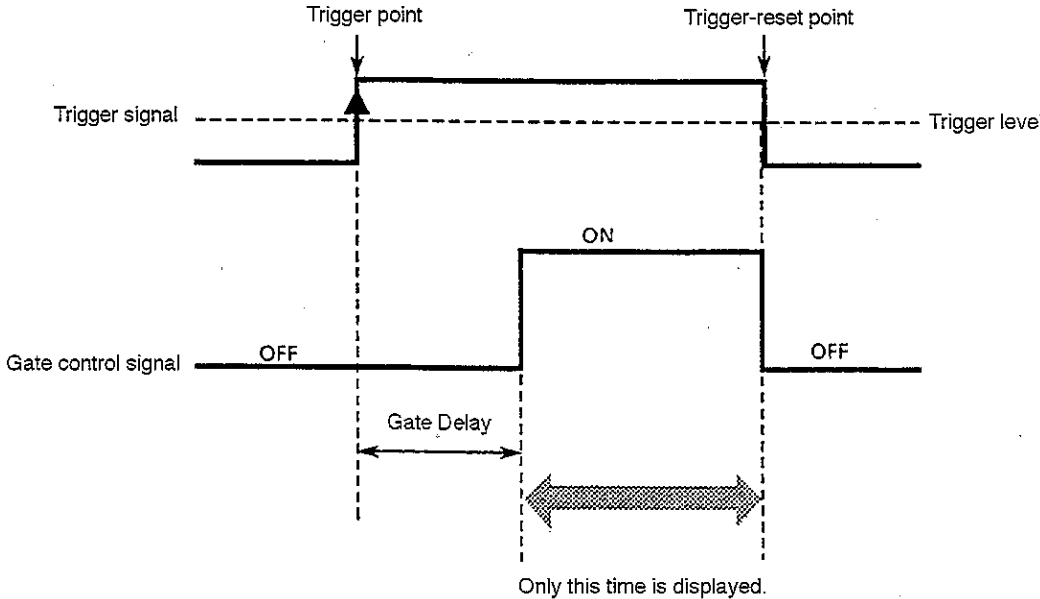

To turn the gate time analysis function On and Off and to create the gate control signal, perform the following key operations.

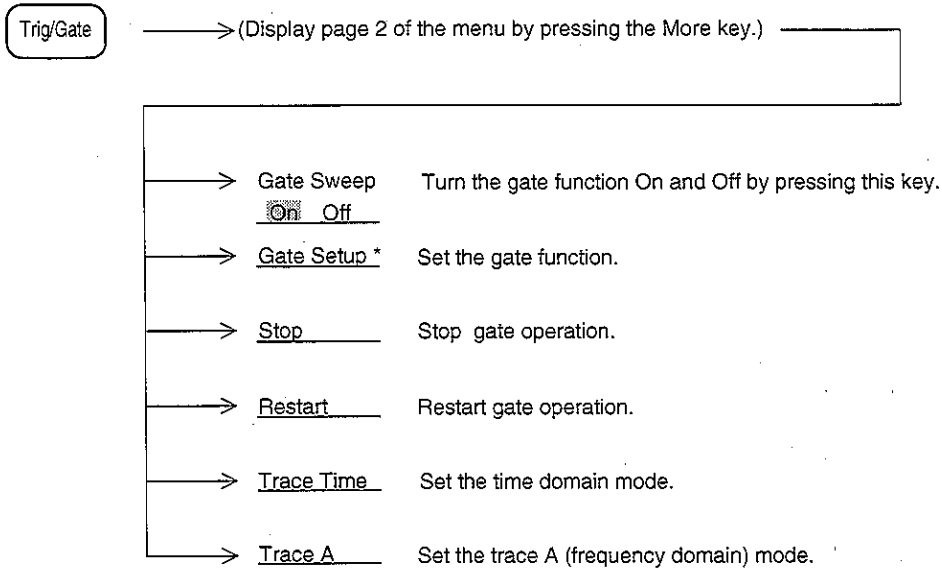

## Setting Gate Function

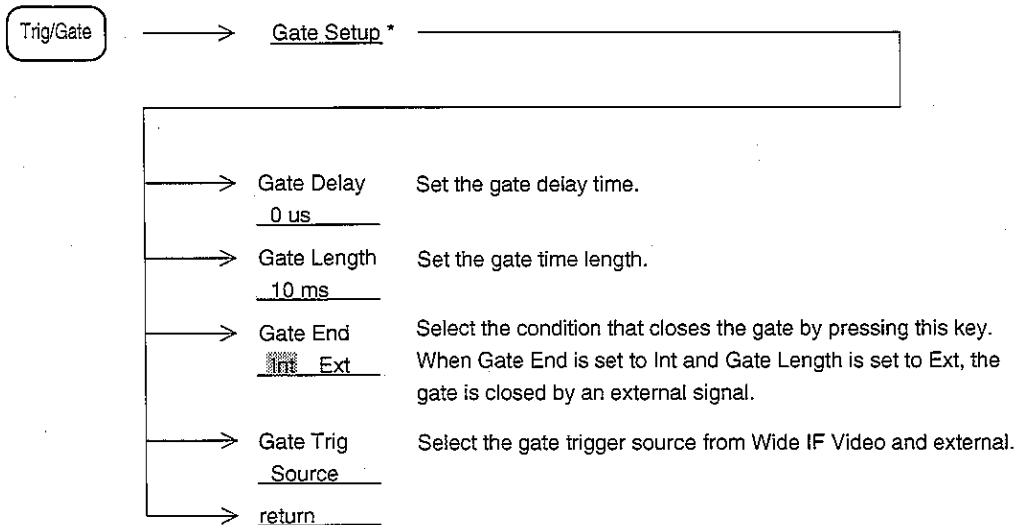

The time domain mode facilitates setting the gate control signal time. The following shows an example of how to use the Time Gate function that uses the time domain mode.

Step	Procedure
1	Input the following signals to the spectrum analyzer.

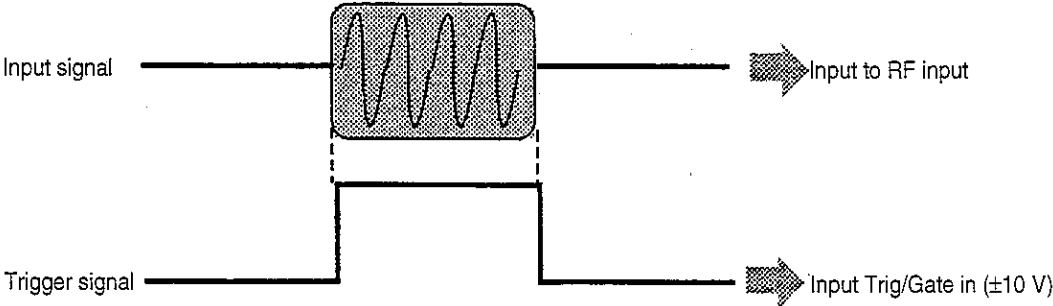

- 2 Display the waveform in the time domain mode. Synchronize the input signal by setting the trigger mode to Triggered and the trigger source to Trig/Gate in (-10 to 10V).

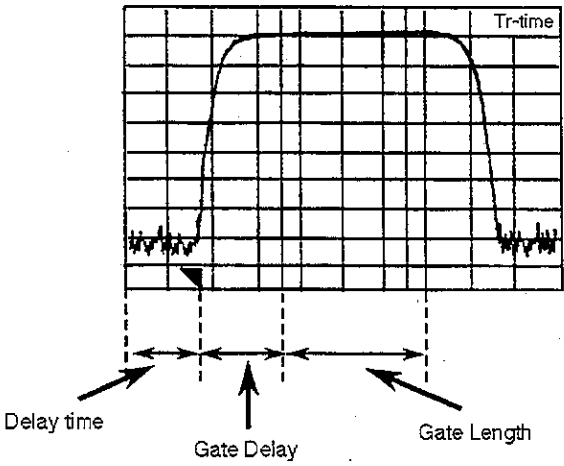

- 3 Set Gate to On. Vertical lines (gate cursor) should appear at the Gate Delay and Gate Length positions. Set Gate Delay and Gate Length to appropriate positions while observing the waveform.  
At this time, adjust the resolution bandwidth and video bandwidth in the time domain mode to equal those in the frequency domain mode, then set the gate cursor positions. The influence of spike-like noises independent of the conditions shown in Note [1] described later can be avoided.

Step	Procedure
4	Set the frequency domain mode. The trigger mode becomes Freerun and the waveform data is displayed only for the time set by Gate Length.

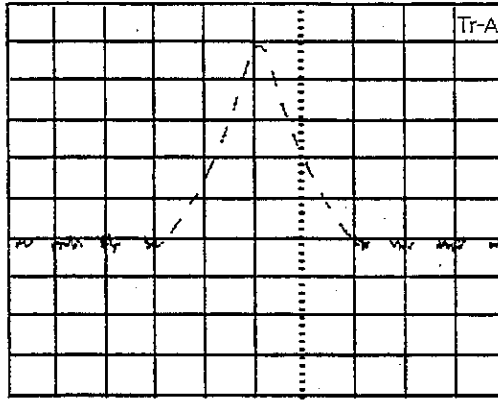

Notes: [1] The detector output is delayed compared to the positive leading edge of the input waveform when the resolution bandwidth (RBW) is narrowed in the frequency domain measurement mode. As a result, spike-like noises may appear on the trace. To prevent this from appearing, set Gate Delay and Gate Length to values that satisfy the following conditions.

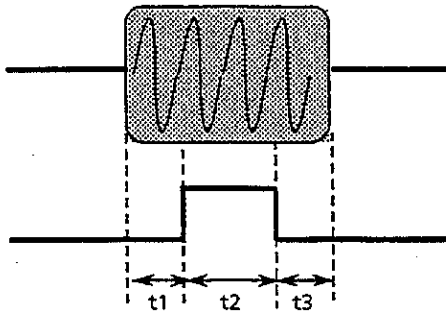

RBW	t1	t2	t3
1 kHz	$\geq 3$ ms	$\geq 20$ $\mu$ s	$\geq 1$ $\mu$ s
3 kHz	$\geq 1$ ms		
10 kHz	$\geq 230$ $\mu$ s		
30 kHz	$\geq 200$ $\mu$ s		
100 kHz	$\geq 20$ $\mu$ s		
300 kHz	$\geq 15$ $\mu$ s		
1 MHz	$\geq 10$ $\mu$ s		
3 MHz			



- [2] When the resolution bandwidth (RBW) is extremely narrow for the frequency span, some waveforms cannot be displayed correctly. Set each parameter so that the following conditions are satisfied.

$$\text{RBW} \geq \frac{\text{Span}}{\text{Number of data points (501)}} \times 5$$

- [3] The Time Gate function can use a video trigger as the gate control signal. In this case, the gate control signal must be generated correctly so that a trigger can be normally set with the same RBW, VBW, and trigger level conditions at all frequencies within the frequency span observed in the frequency domain. (See the figure below.)

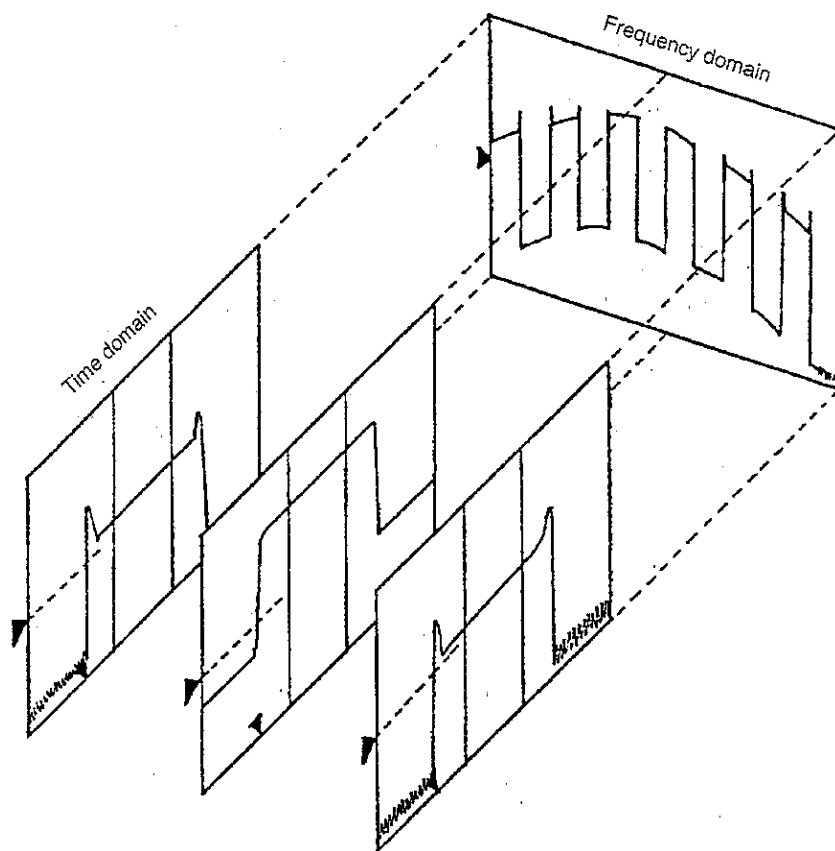

Trigger can be applied by the gate control signal created internally by setting the trigger source to Wide IF Video.

## Domain Sweep

In conducting a sweep by traces A and B (frequency axes), a sweep operation consists of the procedures; setting a center frequency in each sweep, and moving observation frequency. (Lock and Roll)

When "Domain Sweep" function is selected, the frequency setting is done only once in a specified number(Domain count) of sweep operations; and the rest of the sweep operations are performed without this setting.

When the frequency setting is performed, it is necessary to wait for the frequency to stabilize before a sweep can be started. By using "Domain Sweep" function, the time required for frequency to stabilize is saved, and the sweep repetition cycle can be shortened.

- Note:*
- When using "Domain Sweep" function, the specifications on frequency such as frequency stability and frequency indicating determinacy are no longer assured.
  - Selecting "storage mode=Max hold/Min hold/Average" in using "Domain Sweep" function, may result in making the errors between measured levels large. When using "Domain Sweep" function, it is suggested to select "storage mode=Normal".
  - When a certain sweep duration or frequency span is set, sweep repetition cycle may not be shortened even though using "Domain Sweep" function.

## Using Domain Sweep

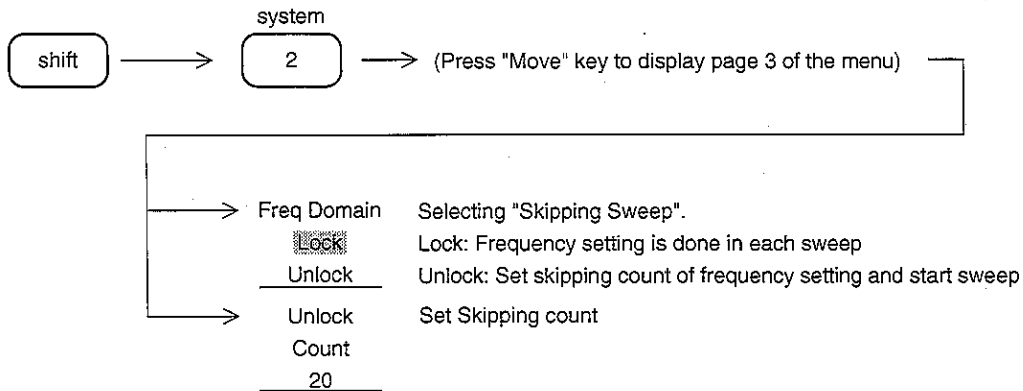

## SECTION 7

### COUPLED FUNCTION

This section describes the coupled function. Generally, the spectrum analyzer automatically selects the optimum values of the coupled function so that both the correct level and correct frequency values can be measured.

This is called the Auto Coupled Function.

This section mainly describes manual settings that are used to set the coupled function according to the application.

### TABLE OF CONTENTS

From Auto to Manual Operation .....	7-4
Resolution Bandwidth (RBW) and Sweep Time .....	7-4
Video Bandwidth (VBW) .....	7-7
Input Attenuator (Atten) .....	7-8



# SECTION 7 COUPLED FUNCTION

The coupled function of the four functions Resolution Bandwidth (RBW), Video Bandwidth (VBW), Sweep Time, and Attenuation (Atten) is initially set to Auto so that the spectrum analyzer can automatically select the optimum setting.

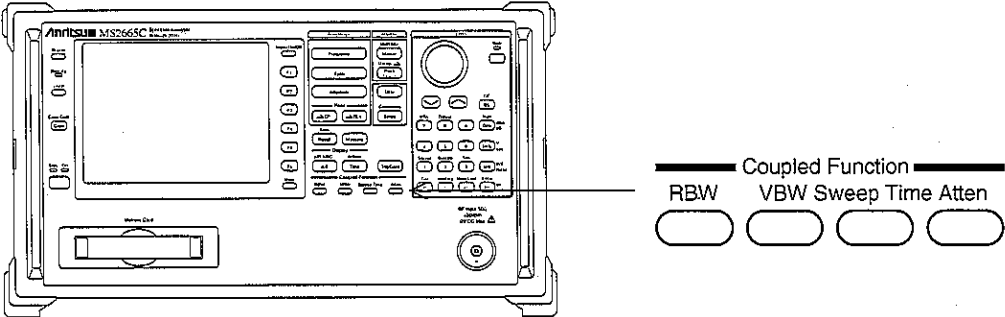

## From Auto to Manual Operation

Perform manual setting as follows:

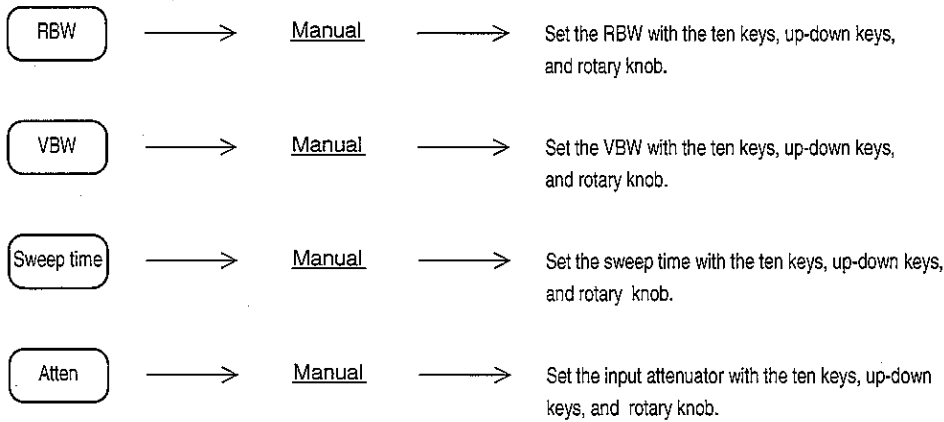

## Resolution Bandwidth (RBW) and Sweep Time

To set the RBW and Sweep Time, perform the following key operations.

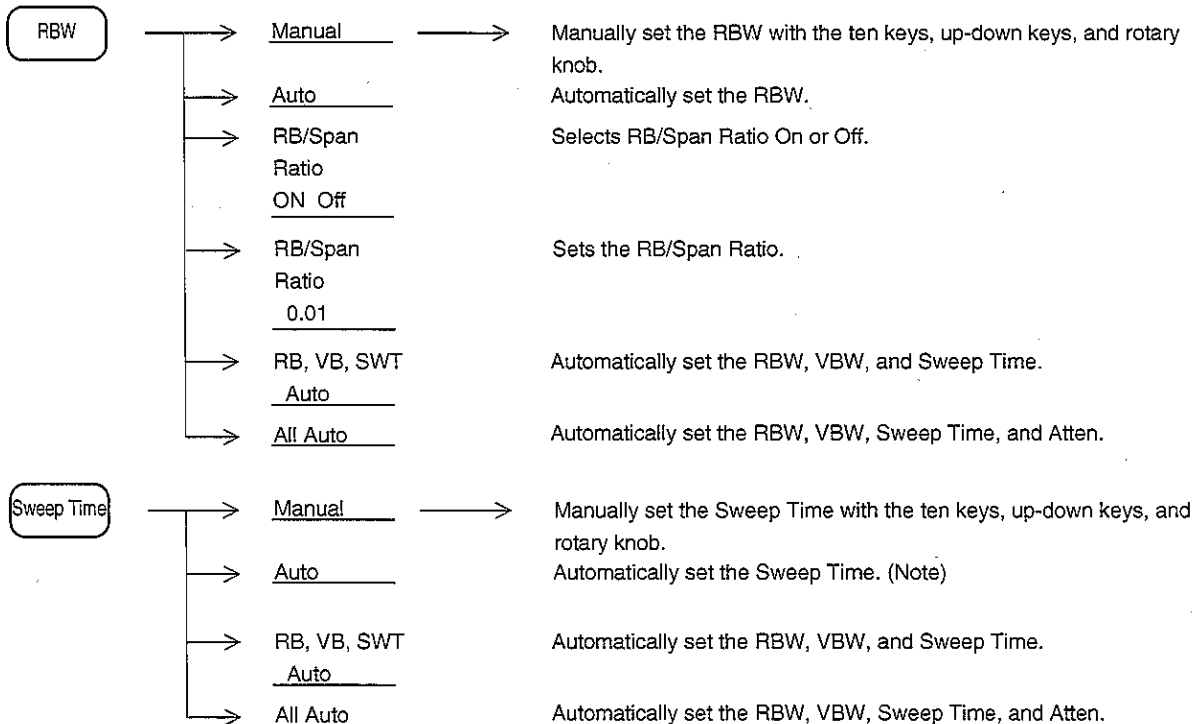

Note: Either of the two automatic set modes (Auto SWT: Hi-Lvl-Acc and Fast) can be selected. Normally, select the Hi-Lvl-Acc mode. See Section 9 for details.

## (1) Auto mode

The RBW, Sweep Time, and VBW parameters are set to Auto so that even if the frequency span is varied, the respective parameters are automatically set to the optimum values so that frequency and level measurement errors do not occur.

The following shows the Swp Time Auto setting range:

- Lower limit value  
20 ms
- Upper limit value  
1000 s

## (2) Manual setting

If RBW, VBW, and Sweep Time are set to the Auto mode, normal measurements can be made without considering their settings.

However, in the following cases, RBW should be set to the Manual mode.

**General measurements:** When observing two adjacent signals, increasing the frequency resolution by narrowing the RBW can reduce the noise level (a tenth part of the current RBW results in a 10 dB reduction).

However, if the RBW is too narrow, the spectrum waveforms will become too steep, the response characteristics become worse, and the sweep time will also become longer. Therefore, the RBW value should be determined to give a practical sweep speed.

**Intermodulation distortion measurement:** When measuring two signal intermodulation distortion with a comparatively wide frequency span and a reduced noise level, the RBW value should be narrowed by manual setting. However, the sweep time increases in inverse proportion to the square of the RBW.

The RBW can be selected from among the following by Manual setting:

- 1 kHz, 3 kHz, 10 kHz, 30 kHz, 100 kHz, 300 kHz, 1 MHz, 3 MHz
- 30 Hz, 100 Hz, 300 Hz (Option 02 Narrow RBW is required.)
- 10 Hz, 30 Hz, 100 Hz, 300 Hz (Option 03 Narrow RBW is required, for MS2667C/68C.)

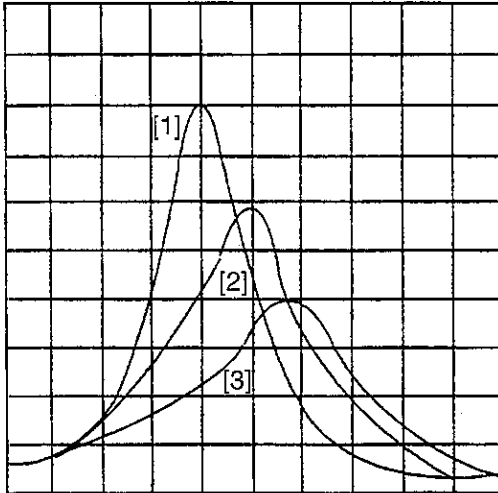

[1] Optimum trace waveform  
[2],[3]UNCAL trace waveforms

Note: The spectrum traces on the screen are displayed as shown at the left according to the sweep time. The optimum sweep time gives a waveform like [1]. However, a sweep time that is too fast decreases the waveform amplitude on the display as shown in [2] and [3]. Therefore, the apparent bandwidth gets wider, and the frequency also shifts. When waveform [1] cannot be maintained, "UNCAL" is displayed.



## Video Bandwidth (VBW)

To set the VBW, perform the following key operations.

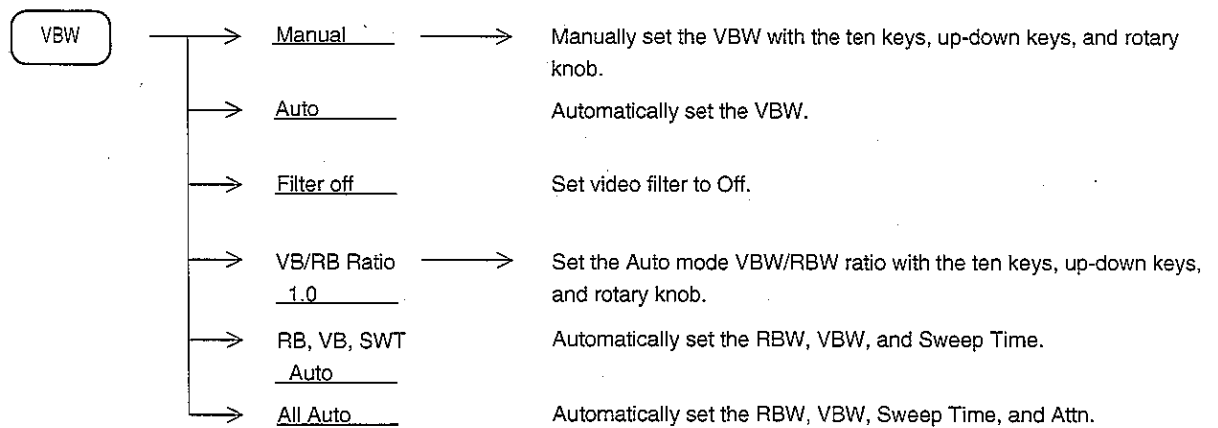

### (1) Auto mode

When VBW is set to Auto, the product of the RBW set value multiplied by the VB/RB Ratio is set. Since VB/RB Ratio is initially set to 1, RBW and VBW are set to the same value.

By setting the VB/RB Ratio to a small value, since VBW is set to a narrow value according to the RBW setting, noise can be efficiently averaged.

**Note:** Since the VBW setting range is 1 Hz to 3 MHz, if an attempt is made to exceed this range, the VBW is set to 1 Hz or 3 MHz.

### (2) Manual setting

When wanting to average the noise by making the VBW narrow without regard to the RBW set value, or when wanting to make the VBW wide to observe the waveform of signals modulated at a high frequency, use Manual setting.

The VBW value can be manually set from among the following values:

1 Hz, 3 Hz, 10 Hz, 30 Hz, 100 Hz, 300 Hz, 1 kHz, 3 kHz, 10 kHz, 30 kHz, 100 kHz, 300 kHz, 1 MHz, 3 MHz, OFF

**Note:**

- When  $\text{VBW} \geq \text{RBW}$  is set, noise is not averaged and the sweep speed is increased.
- Noise can also be averaged without narrowing the VBW (without decreasing the sweep time) by performing video averaging. For further details, see SECTION 5.

## Input Attenuator (Atten)

To set the input attenuator, perform the following key operations.

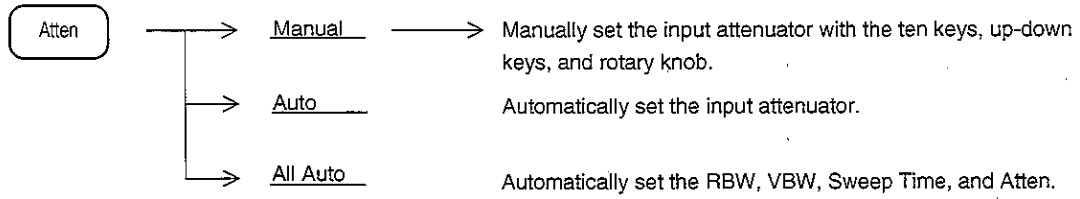

### (1) Auto mode

When the reference level is set while Auto is selected, the input attenuator is automatically set to the optimum value according to the reference level.

## (2) Manual setting

When a signal with the same level as the reference level is input, the input attenuator value in the Auto mode is controlled so that high accuracy measurements can be made without being influenced by gain compression and the noise level can be reduced. However, when you want to measure a low level signal by raising the sensitivity when measuring nonharmonic spurious response and the spurious response of adjacent signals, measurement may be impossible because the Atten values in the Auto mode are too large. In this case, set the input attenuator manually according to the table above.

Reference Level and Input Attenuator (Manual)

Reference Level effective range (dBm)	Atten Manual (dB)
+30 to -30	70
+30 to -40	60
+30 to -50	50
+30 to -60	40
+20 to -70	30
+10 to -80	20
0 to -90	10
-10 to -100	0

A small input attenuator value can be set within the range at which internal mixer level = {(same input level as reference level) - (input attenuator set value) is -10 dBm or less.

For second and third harmonic measurements, the influence of internal distortion must be eliminated by decreasing the mixer input level. Because the internal distortion is -70 dB when the mixer input level is -30 dBm, when wanting to measure spurious harmonics up to -70 dB, the mixer input level must be made -30 dBm or less. In this case, set the input attenuator manually because the Atten value in the Auto mode is too small.

SECTION 7 COUPLED FUNCTION

# SECTION 8

## AUTOMATIC CALIBRATION AND LEVEL CORRECTION FUNCTION

This section describes the internal calibration function and measuring system level correction function which minimize the spectrum analyzer measurement error.

### TABLE OF CONTENTS

Automatic Calibration Function CAL .....	8-3
Automatic Calibration .....	8-4
Details of Each Calibration Item .....	8-5
Preselector tuning .....	8-6
Measurement System Level Correction .....	8-7



# SECTION 8 AUTOMATIC CALIBRATION AND LEVEL CORRECTION FUNCTIONS

## Automatic Calibration Function ..... CAL

The spectrum analyzer incorporates a 625 kHz calibration oscillator and a calibration attenuator, which perform automatic calibration so that the spectrum analyzer can minimize measurement errors and make high accuracy measurements.

### WARNING

If calibration is executed with an external signal applied to the RF input, the correct calibration value cannot be obtained. Perform calibration without applying a signal to the RF input connector.

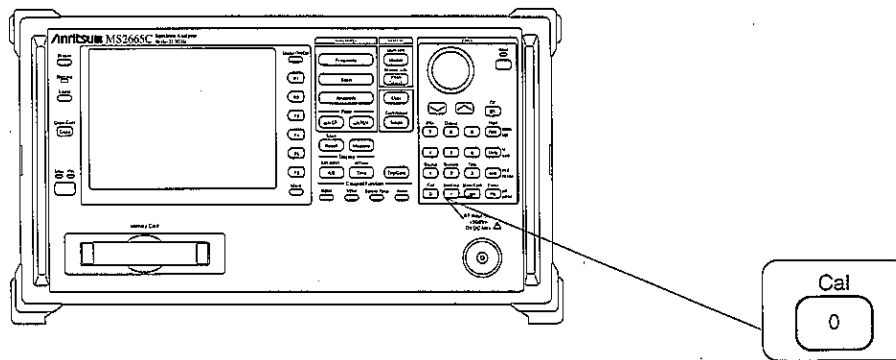

## Automatic Calibration

Execute spectrum analyzer automatic calibration by performing the following key operations.

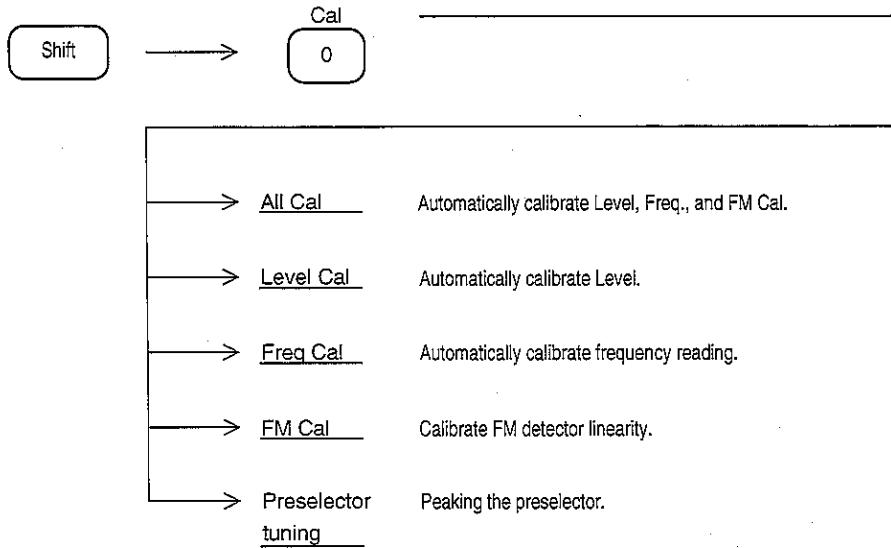



## Details of Each Calibration Item

The following describes the items that are calibrated by the automatic calibration function and the items that are calibrated at the factory.

ALL CAL	LEVEL CAL	Reference level error calibration	Calibrates the absolute-value levels on the LOG/LIN scale.
		LOG-scale linearity calibration	Calibrates the LOG-scale linearity.
		IF Gain switching error correction	Calibrates the error caused by the IF gain from among the level errors when the reference level is switched.
		RBW switching error calibration	Calibrates the error when the resolution bandwidth (RBW) is switched.
		Detection-mode switching error calibration	Calibrates the level error when the detection mode (Pos Peak, Sample, Neg Peak) is switched.
		Input-attenuator switching error calibration	Calibrates the level error when the input-attenuator is switched.
	FREQ CAL	RBW center frequency calibration	Calibrates the center frequency error when the resolution bandwidth (RBW) is switched.
RBW bandwidth measurement		Measures the RBW bandwidth used for noise measurement bandwidth conversion.	
	FM CAL	FM detector linearity calibration	Calibrates the linearity of the FM detector for monitoring FM demodulated waveforms.
Factory Calibration		Frequency response calibration	Calibrates the amplitude frequency response over the entire band.

When ALL CAL is executed, the calibration data is retained by the built-in battery back-up even when the spectrum analyzer power is turned off. Therefore, it is not always necessary to execute automatic calibration each time the power is turned on. However, when a particularly high accuracy measurement is required, when the specifications are not met, or when the set-up circumstances have changed greatly (such as ambient temperature), execute automatic calibration again.

- Notes:
- Since the built-in calibration oscillator is automatically connected internally when automatic calibration is executed, external connection is unnecessary.
  - Unless the frequency span is taken into account, the measurement frequency error depends on the local oscillator frequency error and the IF center frequency error. The local oscillator is a synthesizer system and its frequency error depends on the frequency accuracy of the reference crystal oscillator or external reference signal input. Frequency-related automatic calibration calibrates the IF center frequency error.

# Preselector tuning

Since this equipment is a superheterodyne type spectrum analyzer, it generates unrequired wave responses such as image responses and multiple responses.

This equipment uses a preselector to remove these unrequired wave responses and to display only true signals on the screen. The preselector is a variable synchronous type bandpass filter that follows the receiving frequency of an analyzer. Since the MS2665C/67C/68C uses the preselector in the band 1-, band 1+, band 2+, band 3+, and band 4+ the peaking is described below:

In normal use, since the initial value of the peaking bias is set for each frequency, peaking is required only when the bias value is shifted purposely.

If it is shifted, the receiving level is decreased as shown in the diagram at the bottom left. Accordingly, perform peaking so that the maximum response can be obtained as shown in that figure.

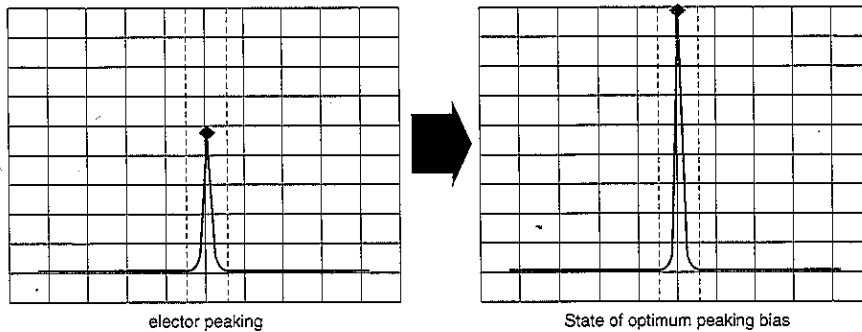

Perform peaking using the following method.

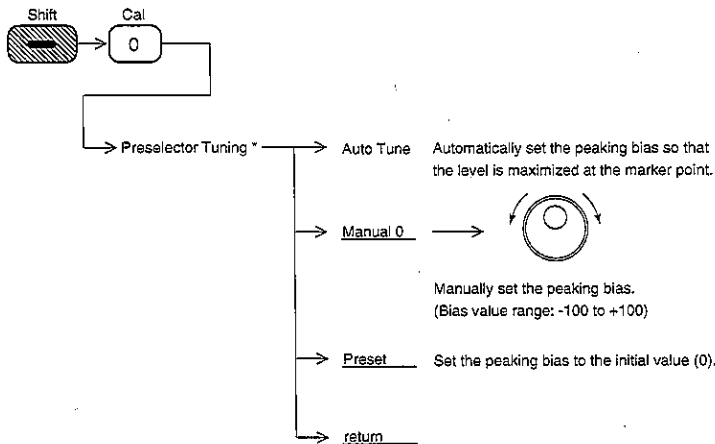

Note: Preselector Auto Tuning cannot be done when:

- The frequency span exceeds 500 MHz.
- The marker is OFF.
- Trace BG is the main trace in the trace A/trace BG indication.
- The FM monitor mode is active in the Time Trace.

## Measurement System Level Correction

When making measurements with a spectrum analyzer, it may be necessary to correct the error and gain of the measurement system. The following are examples of this.

- [1] Frequency characteristics and loss of measurement cables
- [2] Frequency characteristics and loss of pre-amplifier, etc. connected to RF input connector
- [3] When wanting to measure the field strength with an antenna or near-field probe connected (antenna factor correction)

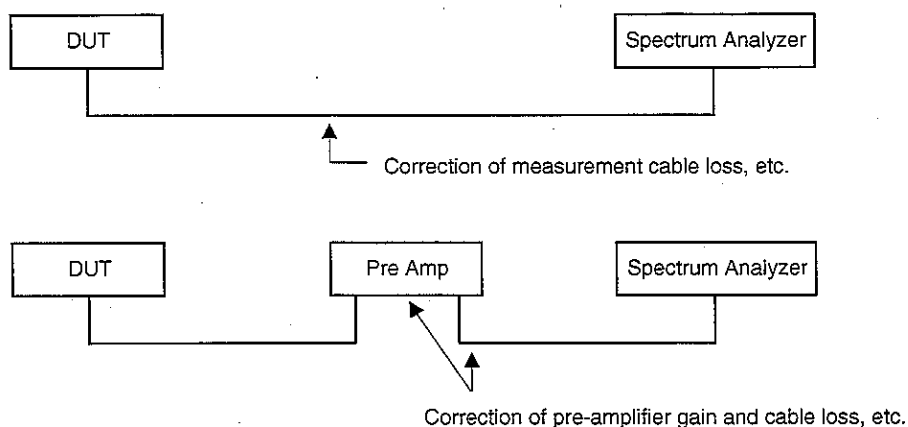

The correction factors for these measurement systems can be stored in the internal memory to add the factor to the measured value and display the spectrum.

Up to five correction factors (maximum 150 points each) can be stored in the internal memory by storage from an external computer via an external interface or by using the internal PTA. For a more detailed explanation of these methods, refer to the Remote Control part of the separate operation manual.

SECTION 8 AUTOMATIC CALIBRATION AND LEVEL CORRECTION FUNCTIONS

The following shows the procedure for adding the correction factor to the measured value by using the correction data saved in advance.

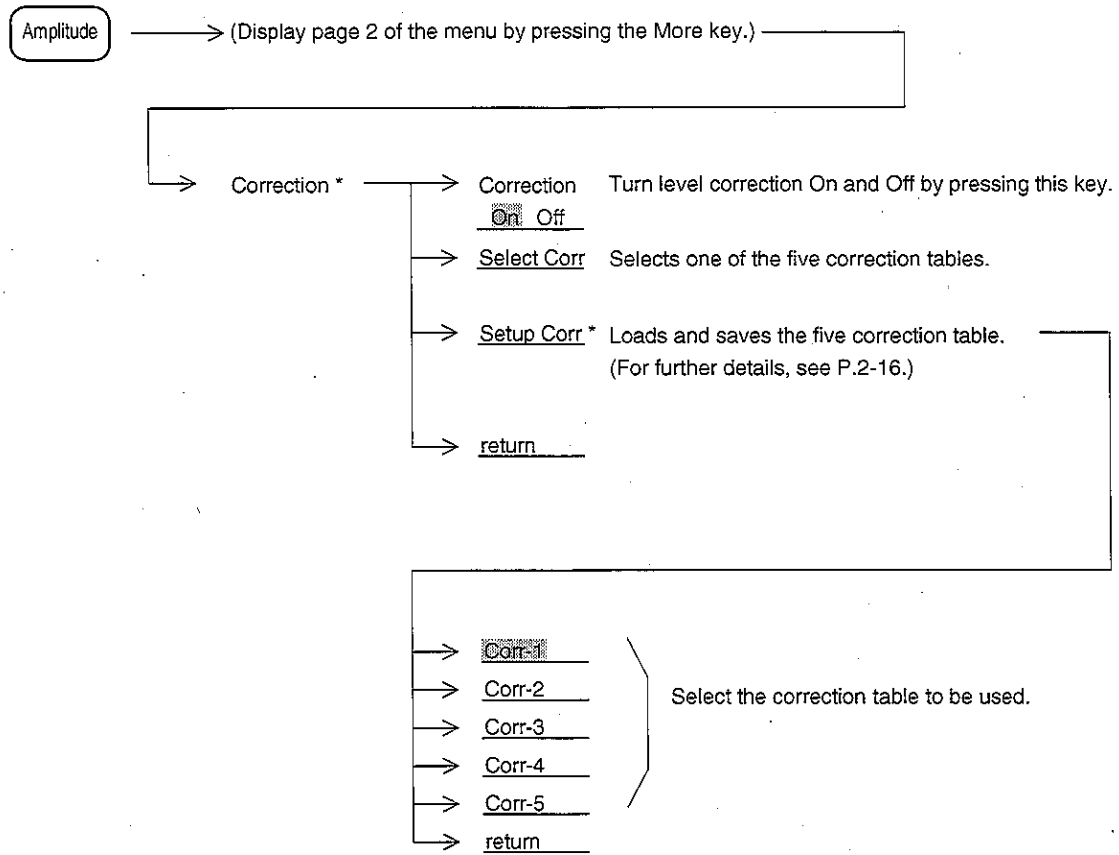

Press one of the Corr-1 to Corr-5 keys. The spectrum data is corrected and displayed by the corresponding correction value.

If the frequency range over which the correction values are entered is from  $F_a$  to  $F_b$ , displayed frequency ranges lower than  $F_a$  or higher than  $F_b$  have correction values applied as shown in the figure below. The correction value for frequencies lower than  $F_a$  is the same as that ( $L_a$ ) for  $F_a$  and the correction value for frequencies higher than  $F_b$  is the same as that ( $L_b$ ) for  $F_b$ .

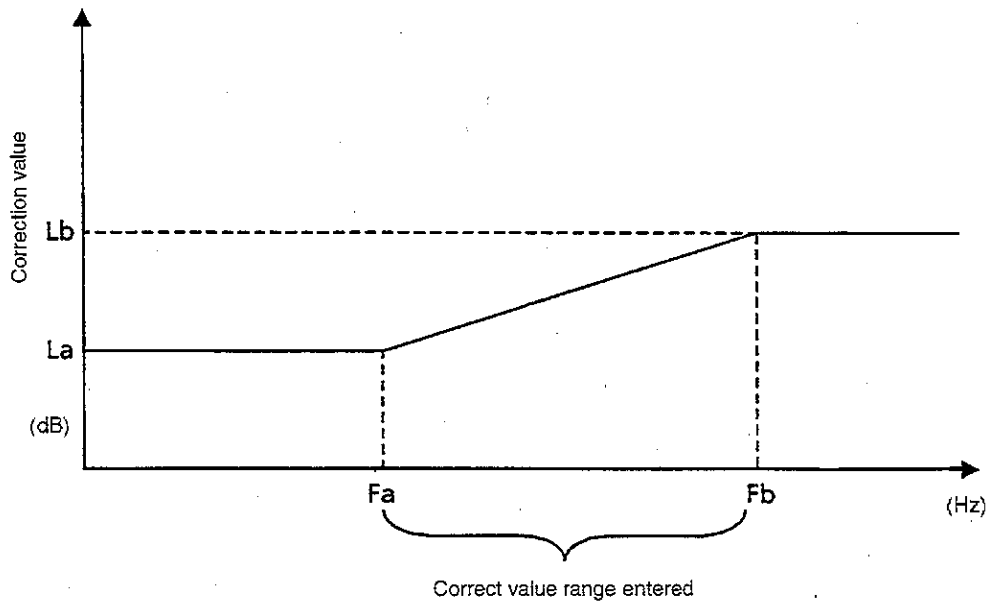

- Notes:
- [1] No correction factor is entered at the factory. The correction values are all 0 dB.
  - [2] The correction value is backed-up by a battery. Therefore, once the value has been entered, it is not lost even after the power is turned off.
  - [3] The Corr-1 to Corr-5 soft keys allow each menu label to have up to 20 characters. The labels can be entered from the remote control command only. For further details, refer to the Remote Control part of the separate Vol.3 operation manual.

SECTION 8 AUTOMATIC CALIBRATION AND LEVEL CORRECTION FUNCTIONS

# SECTION 9

## SYSTEM SETTING AND PRESET FUNCTION

This section describes the spectrum analyzer system setting method and the measurement parameters preset function.

### TABLE OF CONTENTS

Coupled Function Common/Independent Setting Mode .....	9-4
Screen Display Type System Setting .....	9-6
Modifying Display Color (Change Color) .....	9-7
User Definition of Display Color .....	9-8
Adjusting LCD Brightness .....	9-9
Setting Composite Out .....	9-10
Conditions Setting at Power-on .....	9-10
Setting Mode at Auto Sweep Time .....	9-11
Setting Date/Time .....	9-11
Erasing Warm up Message .....	9-12
Switching "X-out, Z-out" output specification in a zero span sweep .....	9-11
Setting Domein Sweep .....	9-13





# SECTION 9 SYSTEM SETTING AND PRESET FUNCTION

The following system parameters of the spectrum analyzer can be set depending on the usage objective.

- Frequency domain and time domain coupled function  
value common/independent setting ..... Coupled Common Independent
- Measurement parameters and date display type setting ..... Display
- Screen display color (color pattern) setting ..... Change Color
- Adjusting LCD brightness for comfortable viewing depending on  
vertical angle of observation ..... LCD Brightness
- Setting Composite Out ..... Composite Mode
- Setting Mode at Auto Sweep Time ..... Auto SWT
- Setting Date/Time ..... Set Date/Set Time
- Erasing warm up message ..... Erase Warm up Message
- Power on state setting ..... Power On State
- Switching X-out, Z-out output specification in a zero span sweep ..... Zero Span
- Setting skipping sweep ..... Freq Domain, Unlock count  
changed when recalled.

These system settings are independent from, and are not affected by, the preset function.

However, they are included in the Save parameters described in SECTION 10, so the system settings may have

## Coupled Function Common/Independent Setting Mode

At factory shipment, the four coupled functions RBW, VBW, Sweep time (Time Span), and Atten are set to have the independent value for frequency domain and time domain.

When these coupling functions are desired to be used with the same sense of operation as zero span of a traditional spectrum analyzer, they can be set commonly by making the following system settings.

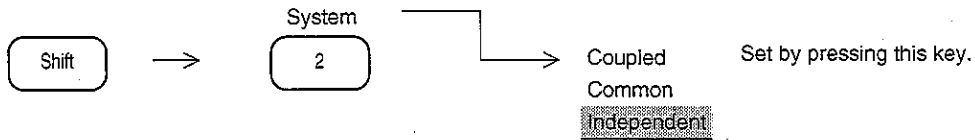

Common ..... The same values are set for both frequency domain and time domain.

Independent ..... Different values are set for frequency domain and time domain.

The Atten value cannot be set independently. When the coupled mode is set to Independent, "RB" and "VB" displayed at the top of the screen change to "RBt" and "VBt", respectively.

**Note:** The sweep time (time span) setting range and resolution in the frequency domain and the time domain differ as shown below. In some cases, the same values cannot be obtained even if the coupled mode is sent to Common.

Frequency domain

20 ms to 1000 s

Resolution: High-order 2 digits

Time domain

12.5  $\mu$ s, 25  $\mu$ s, 50  $\mu$ s, 100  $\mu$ s to 1000 s (with option 04)

Resolution: High-order 1 digit (100  $\mu$ s to 900  $\mu$ s)

High-order 2 digits (1 ms to 1000 s)

**Example:** After switching to the time domain mode to set the time span to 100  $\mu$ s when the sweep time is 300 ms in the frequency domain mode, the display mode returns to the frequency domain mode.



Since the lower limit value of the sweep time that can be set in the frequency domain mode is 20 ms, the sweep time is set to the 20 ms nearest to 100  $\mu$ s. Then, when the display mode switches to the time domain mode, the time span is renewed to 20 ms.

## Screen Display Type System Setting

This function selects the measurement parameters display type and date display type that are displayed on the screen.

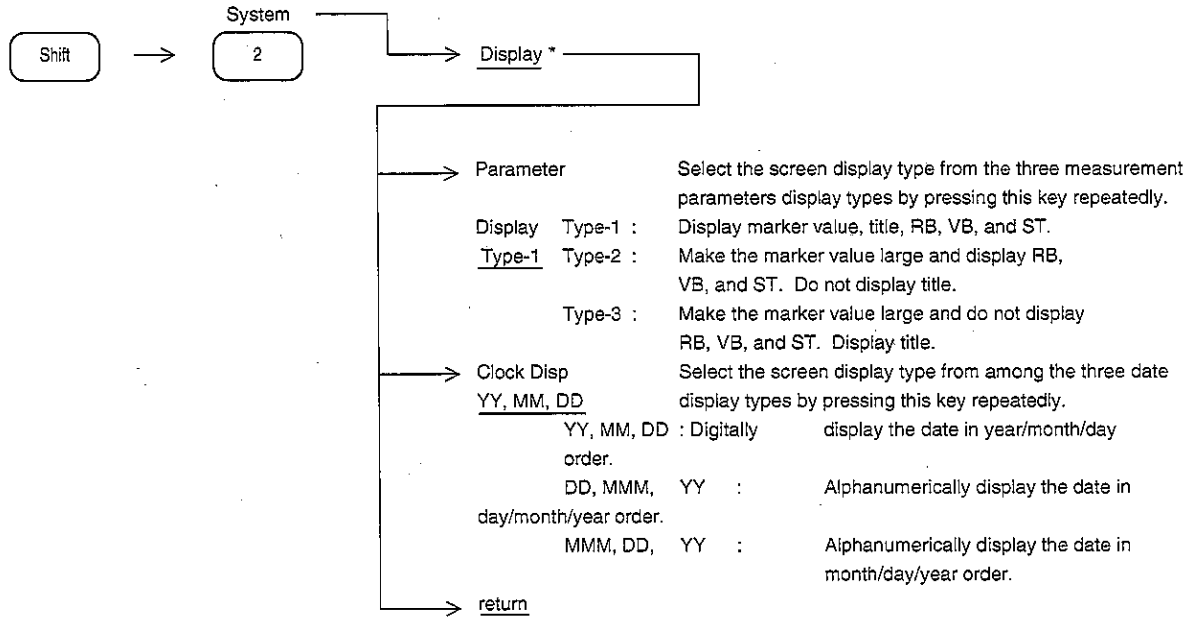

## Modifying Display Color (Change Color)

This function changes the color of the trace waveform, scale, measurement parameters, menu, and other items displayed on the screen. The color pattern can be selected from among four color patterns, or defined by the user.

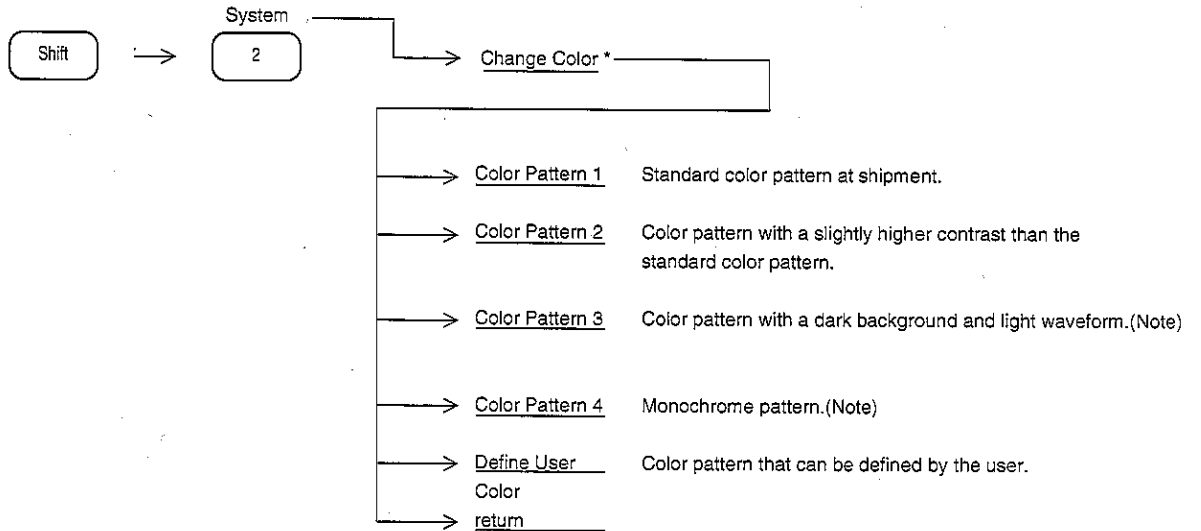

**Note:** Mainly use color pattern 3 when using in the dark place.  
Mainly use color pattern-4 when photographing the display screen.

## User Definition of Display Color

The MS2665C spectrum analyzer has a color pattern function that allows the user to define the color of the trace waveform, scale, measurement parameters, menu, and other items displayed on the screen.

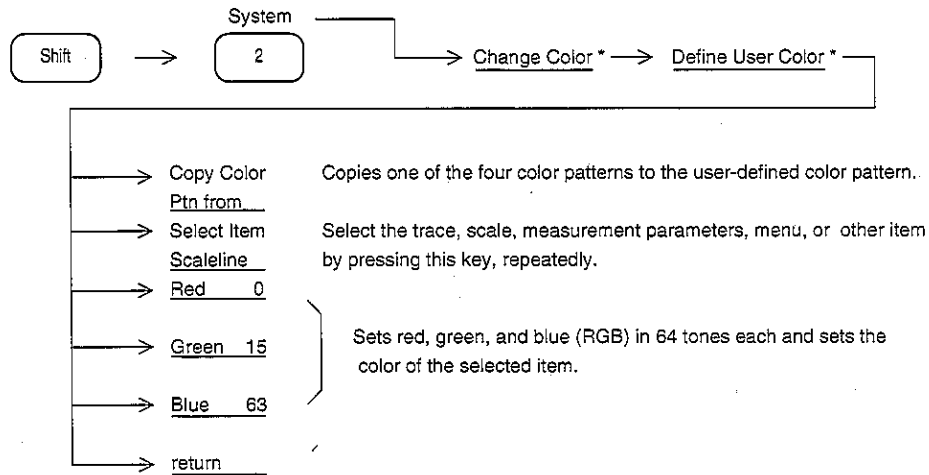

*Note:* Marker, PTAScreen, Menufield, Menutext, EntryArea, Background, Scalefield, Scaleline, 2ndTrace, 1stTrace, Parameter, Displayline, Trigger, Zone, Temp/Mask, and MultiMarker can be selected.

## Adjusting LCD Brightness

LCD Brightness can be adjusted by the following key operations.

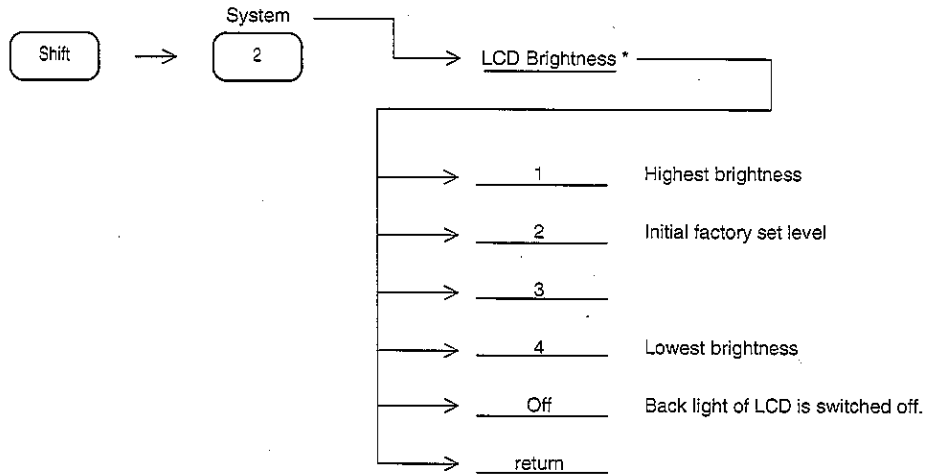

*Note:* LCD type display have a particular range of angle for comfortable viewing depending on the level of brightness of the display.

*In this instrument level of brightness (see figure below) varies from 1 to 4 as the point of observation goes from above to below.*

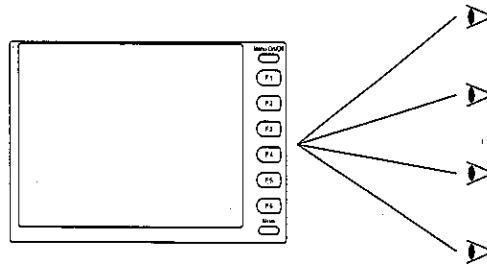

- When the display is in backlight off mode, the brightness can be brought back by either setting a display level 1 to 4 or by the **PRESET** key.
- LCD backlight off mode is useful when there is no need for human observation of the display. Also the speed of processing increased, if the backlight is switched off in remote controlled mode of operation.

## Setting Composite Out

Switching of the Video signal form the Composite Out terminal at the rear panel is carried out by the following key operations.

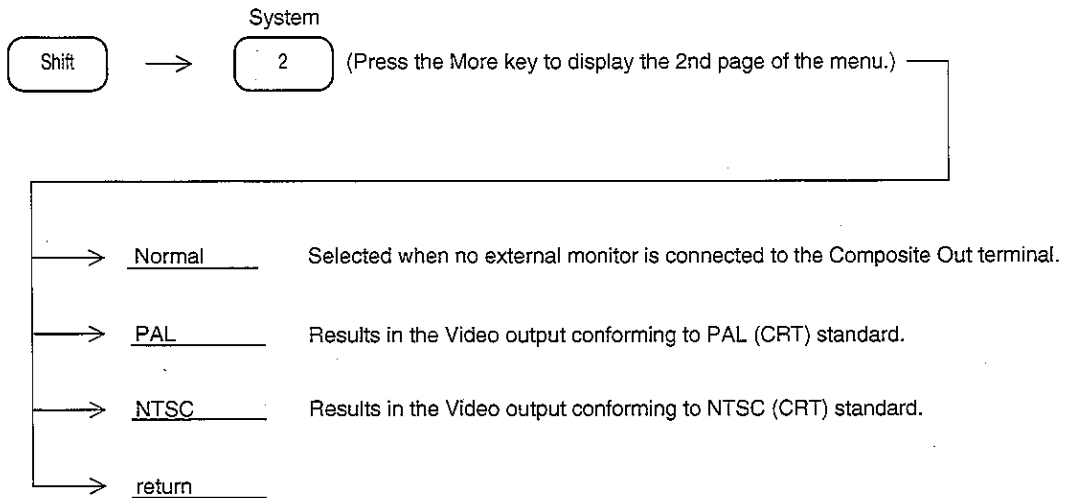

## Conditions Setting at Power-on

Set the state of the screen display when the power is turned on by performing the following key operations.

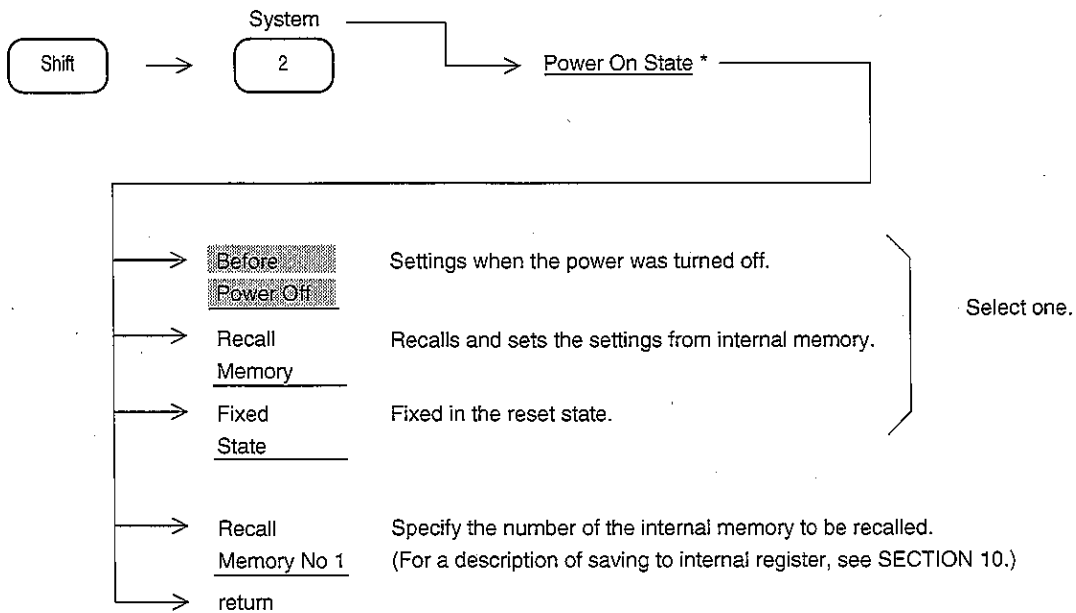



## Setting Mode at Auto Sweep Time

Set the sweep time mode when sweep time is Auto.

Normally, select the Hi-Lvl-Acc mode.

In Fast mode, the sweep time becomes fast, but level-measurement error may increase by approx. 1 dB.

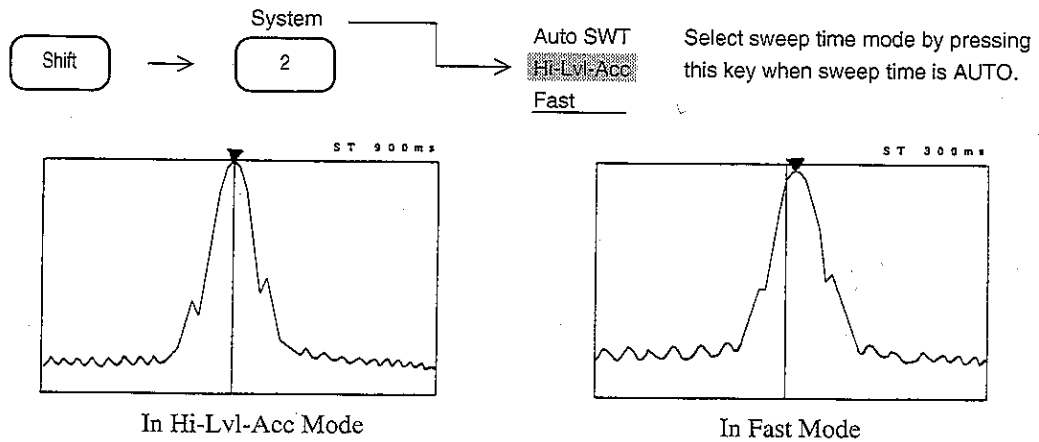

## Setting Date/Time

Set the date and time by performing the following key operations.

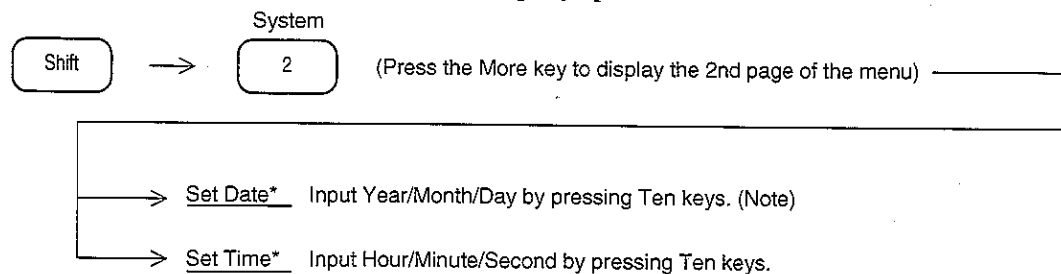

Note: For an example, when inputting 1st January 1996,

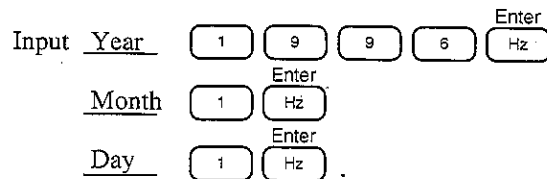

## Erasing Warm up Message

"Warm up" message is indicated on the top right of the display for about 3 minutes after turning on the power. This message is indicated because it is necessary to wait for frequency to stabilize when a frequency span is 200kHz or less. This message can be erased.

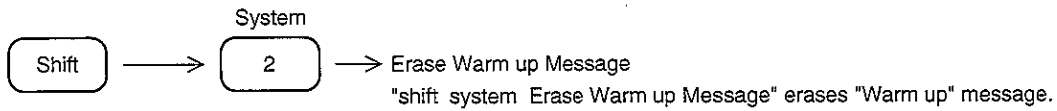

## Switching "X-out, Z-out" output specification in a zero span sweep

Using Option 15, sweep signal output, image signals of spectrum analyzer (X, Y, Z: Y-out is the standard, and X-out/Z-out is an option) can be output and observed by an oscilloscope or the like.

When indicated waveforms are the traces A and B (frequency axes), each signal is output by the following timing.

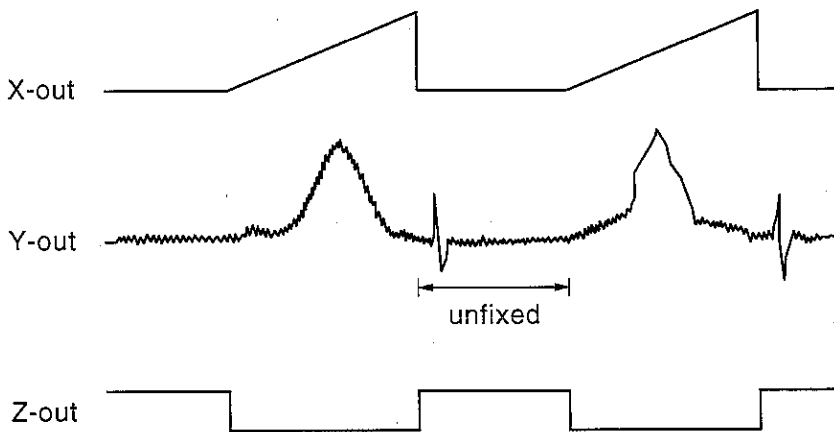

Zero Span Sweep: When trace "Time" (time axis), normally Y-out only is output, and X-out and Z-out are not output. The mode in a zero span sweep is usually set at "Digital". When X-out and Z-out signals are necessary in a zero span sweep, set the zero-span mode at "Analog".

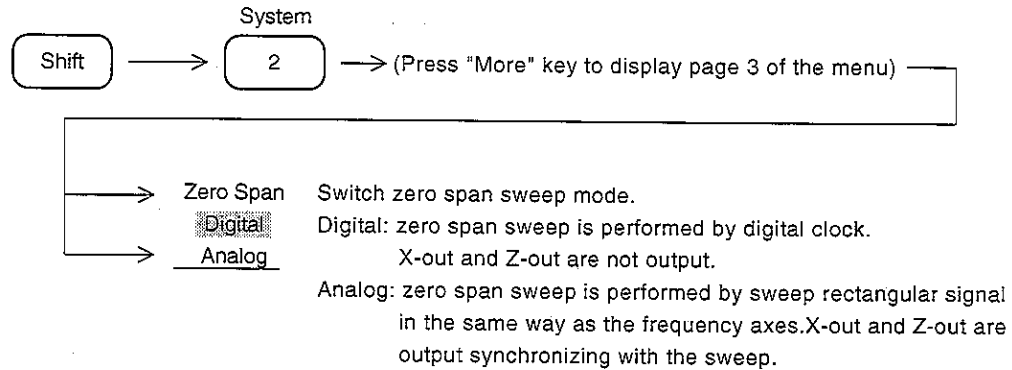

*Note:* When switching the zero span sweep mode to "Analog", a sweep duration is limited to 20ms or more. Even if Option 04 high speed time domain sweep, is mounted, the duration cannot be set at less than 20ms.

## Setting Domein Sweep

Refer the Section 6 "Selecting Sweep Method" "Skipping Sweep".

SECTION 9 SYSTEM SETTING AND PRESET FUNCTION

# SECTION 10

## SAVE/RECALL FUNCTION

This section describes saving and recalling of the waveform and parameter data to and from internal register and memory card, respectively.

It also describes memory card file management.

### TABLE OF CONTENTS

Internal Register .....	10-4
Memory Card .....	10-4
Saving Parameter and Waveform Data .....	10-5
Recalling Parameter and Waveform Data .....	10-7
Selecting Recall Item .....	10-9
Memory Card File Management .....	10-10
File Deletion and Write Protect .....	10-11

SECTION 10 SAVE/RECALL FUNCTION

# SECTION 10

## SAVE/RECALL FUNCTION

The spectrum analyzer can save the setting conditions (Parameter) and waveform data (Trace) to internal register and memory card. These data can be recalled and used later.

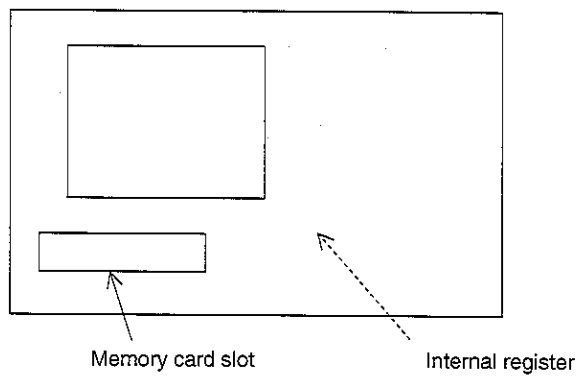

## Internal Register

The internal register uses the RAM backed-up by a battery in the spectrum analyzer.

Up to 12 parameters and waveform data can be saved. Parameters and waveform data, or parameters only, can be recalled.

## Memory Card

The memory card is an interface that corresponds to JEIDA Ver.4/4.1 type 2, and PCMCIA Rel. 2.0, 2 slots. Memory capacity can be selected from among 256kB, 512kB, 1024kB, and 2048kB.

Parameters and waveform data can be saved and parameter and waveform data, or parameters only, can be recalled.

(A 256kB memory can save more than 50 files.)

PTA programs created by external controller, etc. can also be uploaded and downloaded.



## Saving Parameter and Waveform Data

To save the current parameters and waveform data and title to internal register or memory card, perform the following key operations.

When a title is necessary, enter it in advance. (See SECTION 12.)

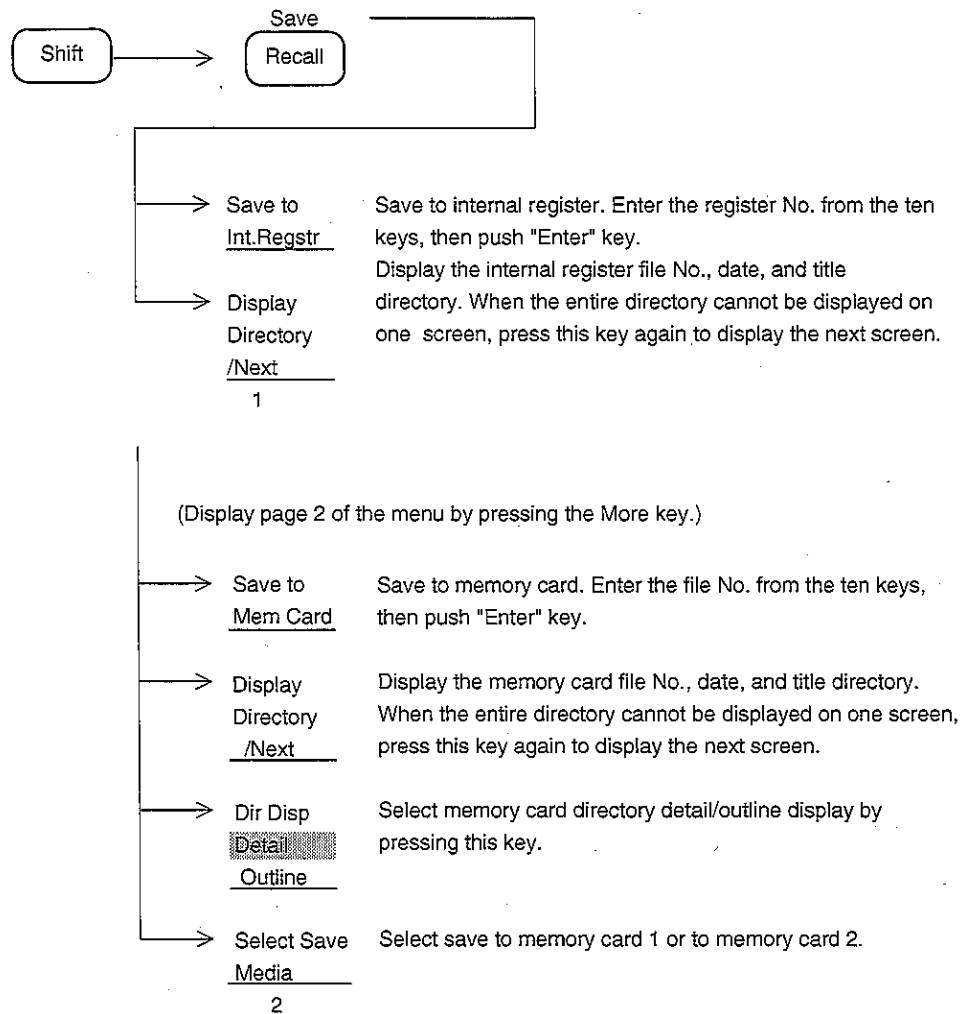

**Note:** Since the Save operation overwrites the data written using the same register/file number, check the directory before doing any saving.

<Memory Directory>			<u>save</u>
No.	Date	Title	
01	97-09-15	Noise Level Measurement	
02	97-09-23	FALL 0923	
10	97-10-10	SPRT 1010	
12	97-11-03	CLTR	

Save Int. Reg. NO=

Internal Register Directory Display Screen

## Recalling Parameter and Waveform Data

To recall the saved parameters and waveform data or parameters only from internal register or memory card, perform the following key operations.

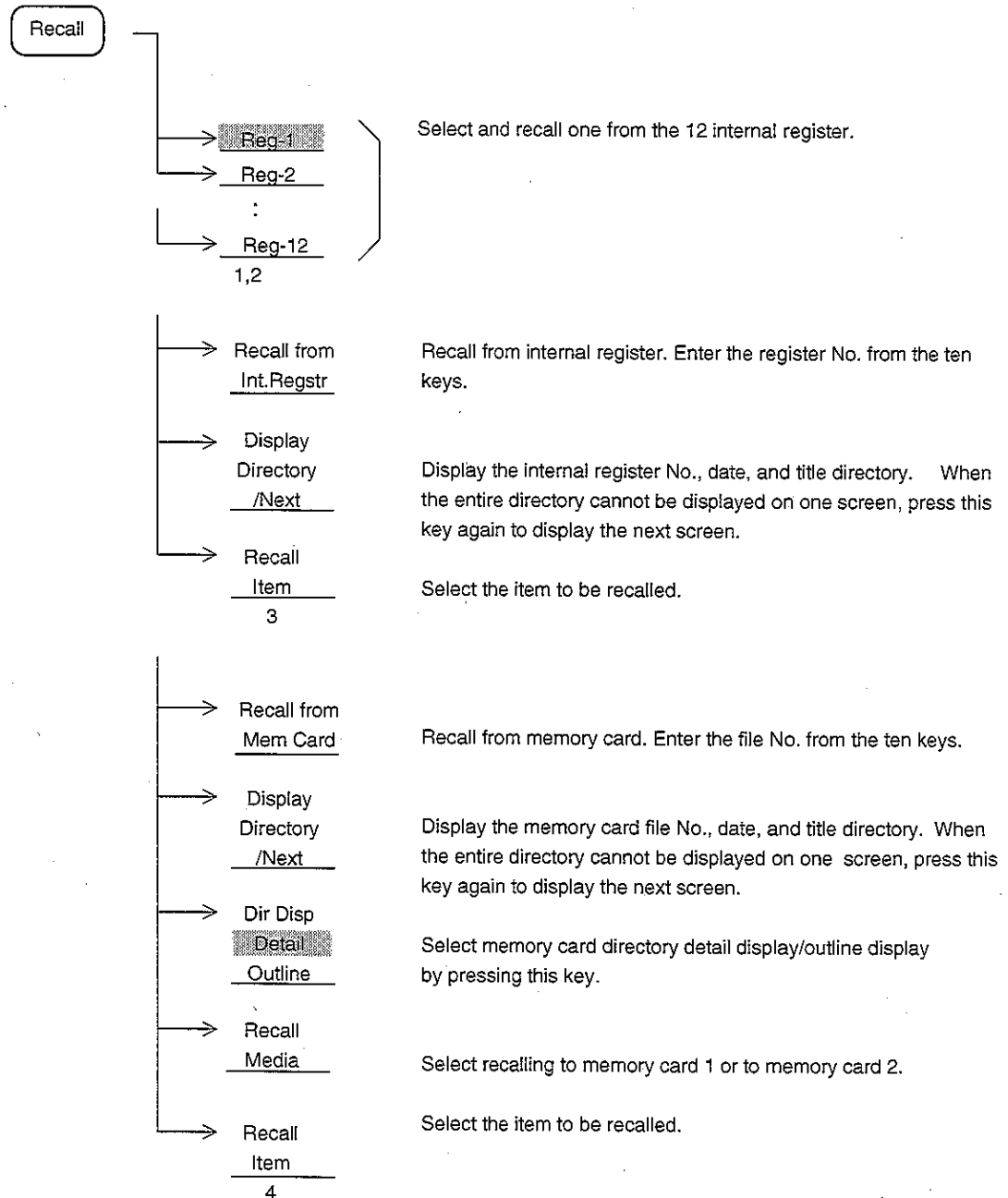

- Notes: [1] Waveform data should be saved in the View storage mode or in the state while stopped after a single sweep. Resweep immediately after recall clears from the screen display the data saves during continuous sweep.
- [2] The Cumulative and Overwrite storage modes allow the last-swept waveform data to be saved.
- [3] Since the system settings described in SECTION 9 MEASUREMENT SYSTEM SETTING (Coupled Mode) are included in the parameters to be saved, they may have changed when recalled.

<File Directory> Recall

Media: Mem Card-1  
 Unused Area: 205 824 byte  
 31 Files in \P-2110\TRACE

Name	Title	Bytes	Date	Protect
TRACE001	DAT Carrier Power Measure	2608	97-05-16 09:04	Off
TRACE002	DAT Power steps Measure	2608	97-05-16 09:04	Off
TRACE003	DAT PvsT full frame Measure	2608	97-05-16 09:04	Off
TRACE004	DAT PvsT full slot Measure	2608	97-05-16 09:04	Off
TRACE005	DAT PvsT top 10dB Measure	2608	97-05-16 09:04	Off

Recall File No =

(Detail)

<File Directory> Recall

Media: Mem Card-1  
 Unused Area: 205 824 byte  
 31 Files in \P-2110\TRACE

No.	Date	Title
001	97-05-16	Carrier Power Measure
002	97-05-16	Power steps Measure
003	97-05-16	PvsT full frame Measure
004	97-05-16	PvsT full slot Measure
005	97-05-16	PvsT top 10dB Measure
006	97-05-16	PvsT Rising edge Measure
007	97-05-16	PvsT Falling edge Measur
008	97-05-16	Intermod measure (carr
009	97-05-16	BS Tx band(800kHz abov
010	97-05-16	BS Tx band(800kHz belo
011	97-05-16	BS Rx band(3rd) measure

Recall File No =

(Outline)

Memory Card Directory Display Screen

## Selecting Recall Item

Select the item to be recalled by performing the following key operations.

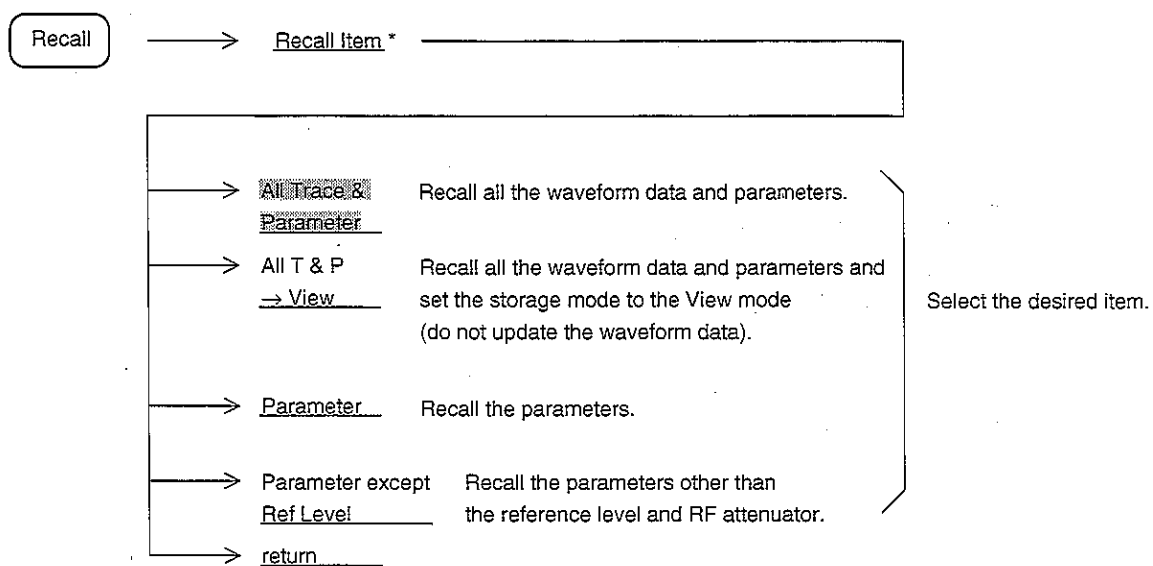

## Memory Card File Management

This parameter describes the memory card format, file deletion, and write protect key operation.

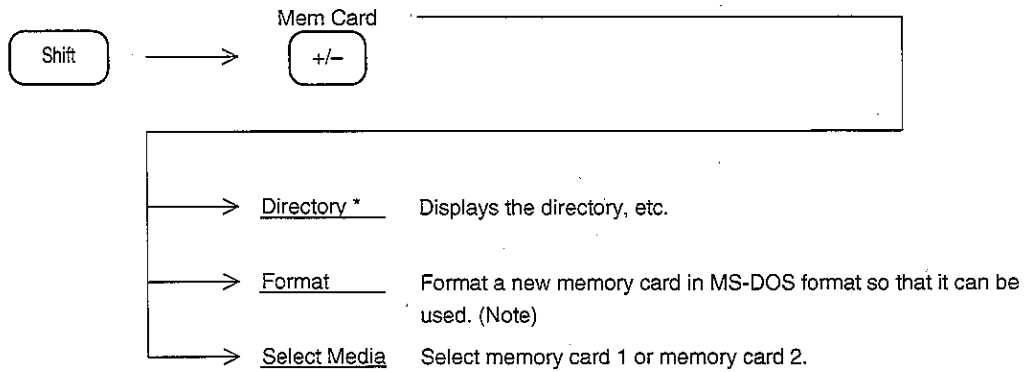

**Note:** When a memory card is formatted, all the file contents are deleted even if they are write-protected as described below.

MS-DOS is a registered trade mark of the Microsoft Corporation.

## File Deletion and Write Protect

To delete a file and set write protect, perform the following key operations.

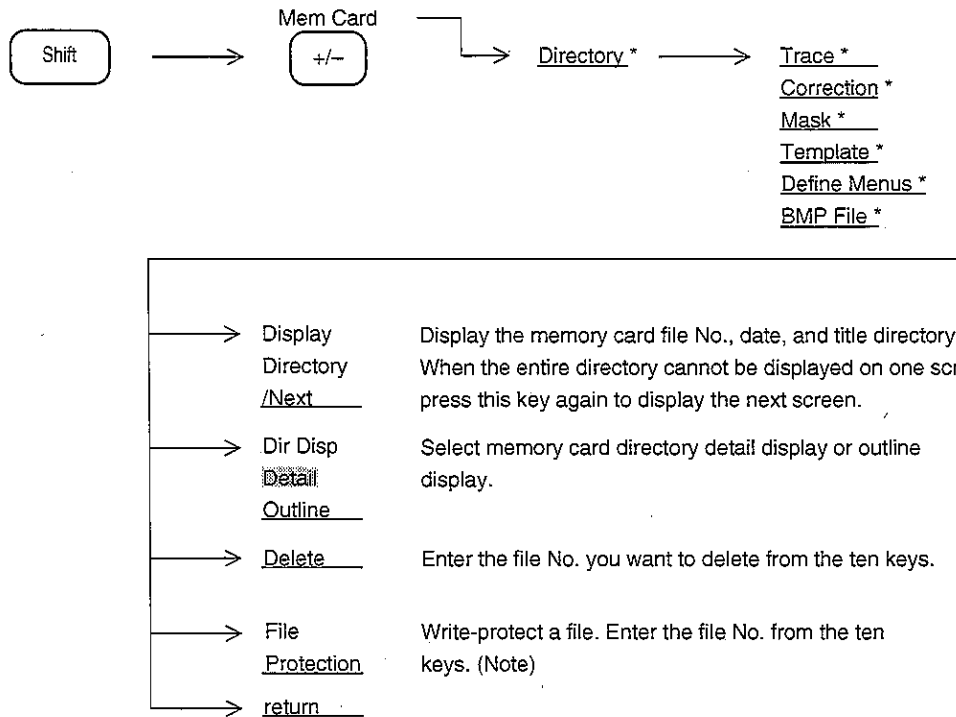

**Note:** The operation above releases write protection of the protected file. Write-protected files are displayed with "protect" in the memory card directory displayed set to "on" and cannot be saved or deleted. Note that the formatting deletes the protected file.

SECTION 10 SAVE/RECALL FUNCTION



# SECTION 11

## COPY/SOUND MONITOR

This section describes the COPY function for hard-copying the contents displayed on the screen, the SOUND function for monitoring an AM or FM modulated sound signal.

### TABLE OF CONTENTS

Direct Plotting .....	11-3
Connecting to Printer and Plotter .....	11-3
Selecting a Printer/Plotter .....	11-4
Selecting a Printer .....	11-5
Setting the Plotter .....	11-6
Setting Interface .....	11-7
Executing Hard Copy .....	11-8
Saving Screen Image Data to Memory Card .....	11-9
Selecting Memory Card .....	11-9
Executing Save .....	11-9
Executing Save by Specifying File Number .....	11-10
Displaying the Screen Image Data on PC .....	11-10
Displaying a Title .....	11-11
SOUND Monitor .....	11-12
AM Wave Sound Monitor .....	11-13
FM Wave Sound Monitor .....	11-13



# SECTION 11 COPY/SOUND MONITOR

## Direct Plotting

The spectrum analyzer can output a hard copy of the screen as follows:

- [1] Using a printer via RS-232C interface.
- [2] Using a printer via GPIB interface.
- [3] Using a printer via Centronics (Option) interface.
- [4] Output to a plotter in the specified format via RS-232C interface.
- [5] Output to a plotter in the specified format via GPIB interface.

However, the printer is limited to HP dot image and EPSON dot image types.

The plotter is limited to HPGL and GPKL types.

## Connecting to Printer and Plotter

Connect the spectrum analyzer and printer/plotter as shown below.

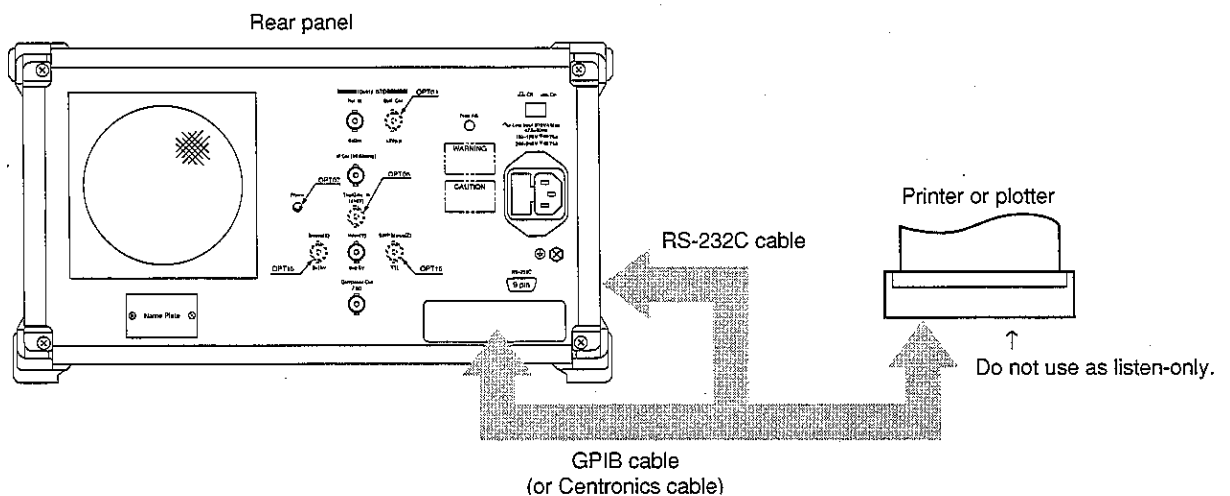

## Selecting a Printer/Plotter

To select printer/plotter, set-up the printer/plotter, feed the paper, stop printing, etc., perform the following key operations.

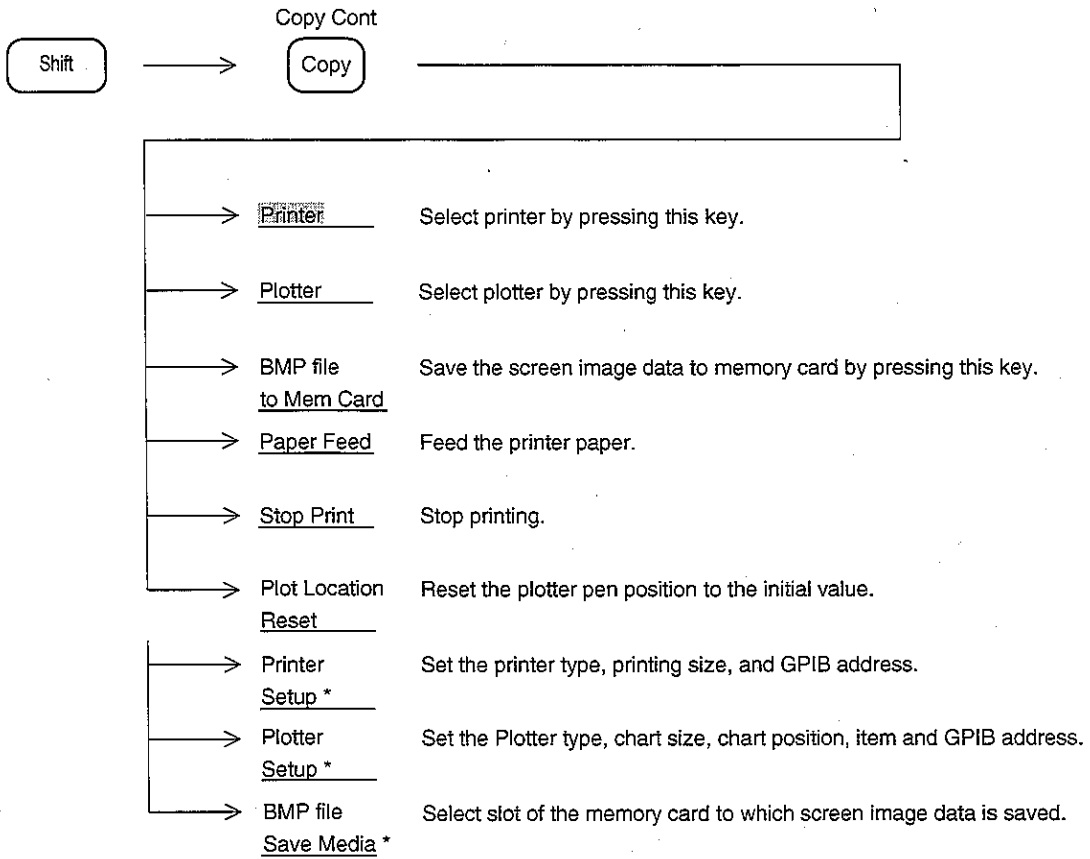

## Selecting a Printer

To select the printer to use and to set its GPIB address, perform the following key operations.

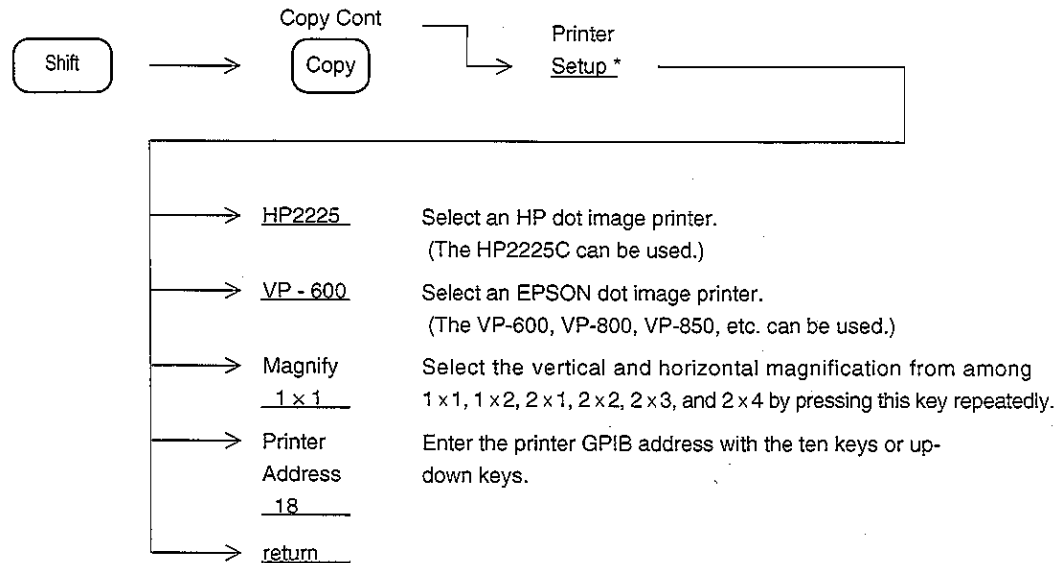

1 x 1	1 x 2
-------	-------

2 x 1	2 x 2
-------	-------

2 x 3
-------

2 x 4
-------

Print Magnification Selection

## Setting the Plotter

To select the plotter to use and to set its GPIB address, perform the following key operations.

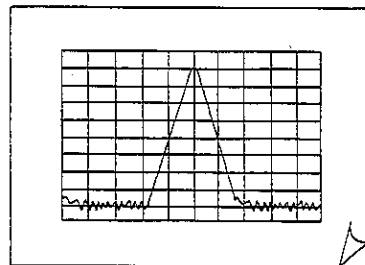
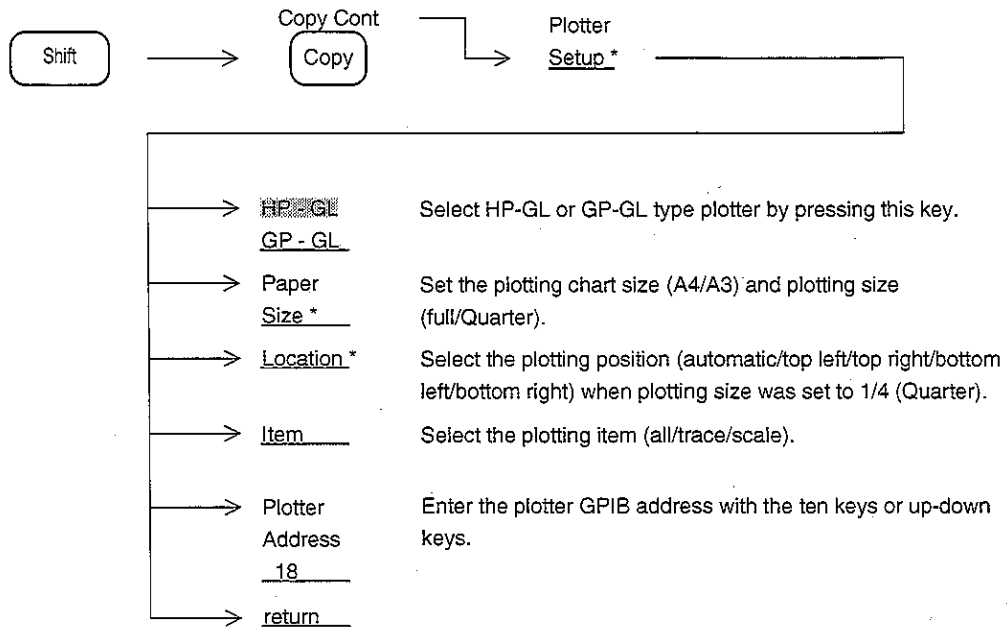

When Full Size is Specified for Plotting

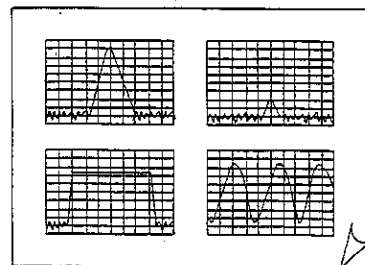

When Quarter Size is Specified for Plotting

## Setting Interface

To set the RS-232C baud rate and interface with external devices, perform the following key operations.

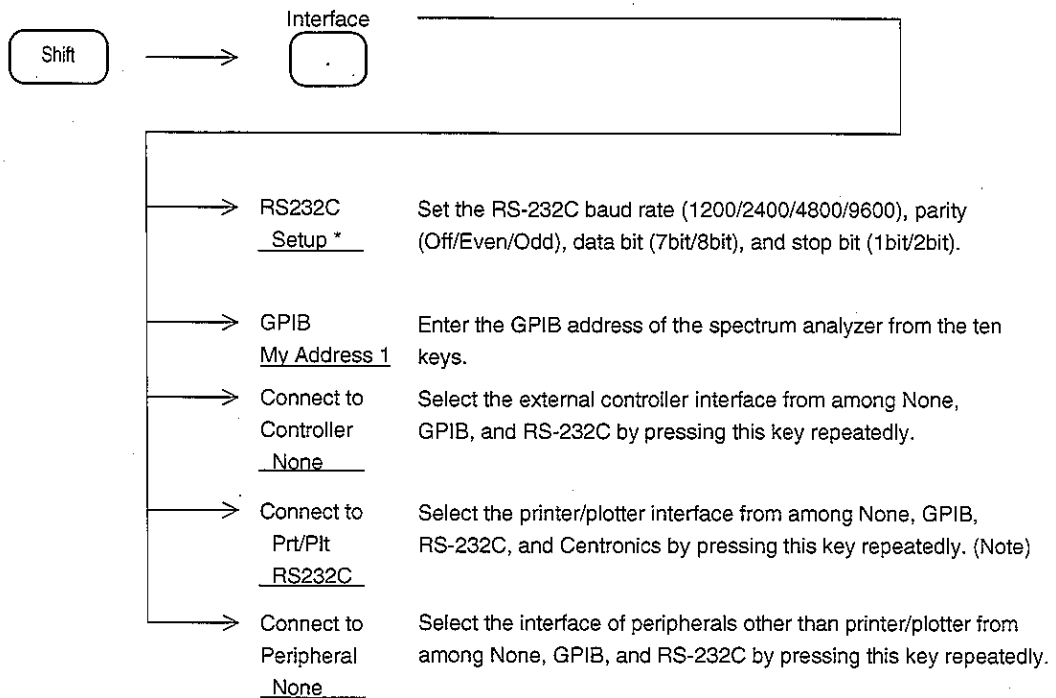

Note: When GPIB is selected as the external controller, for Prt/Plt, select from None and RS-232C.

## Executing Hard Copy

Start hard copy by pressing the  key. When the screen-image data saving is selected, saves the data to the memory card.

Note: Set the printer or plotter to the ON LINE mode.

Notes: • Some printer and plotter models take a considerable time to output a hard copy. This may cause a time-out error in the spectrum analyzer and the hard copy operation may be interrupted. In this case, modify the time-out setting value via GPIB using an external controller.

```
Nss-BASIC ..... PRINT Δ @1 ; "GTOUT Δ 60"
PTL ..... PUT Δ "GTOUT Δ 60"
```

Integer represented in units of second(s)

- Immediately after setting the copy execution, the sweep stops for a few seconds because of editing process of the data. After restarting the sweep, and beginning the printing at printer/plotter; the parameters etc. can be set. After completion of the current copying, perform the next copying.



## Saving Screen Image Data to Memory Card

The screen display contents can be saved to a memory card as a BMP-format(standard image data format of the Windows) file. After saving, the file in the memory card can be opened on the Windows of PC.

### Selecting Memory Card

To select the screen-image-data saving function and the memory-card slot at the front panel, perform the following key operations.

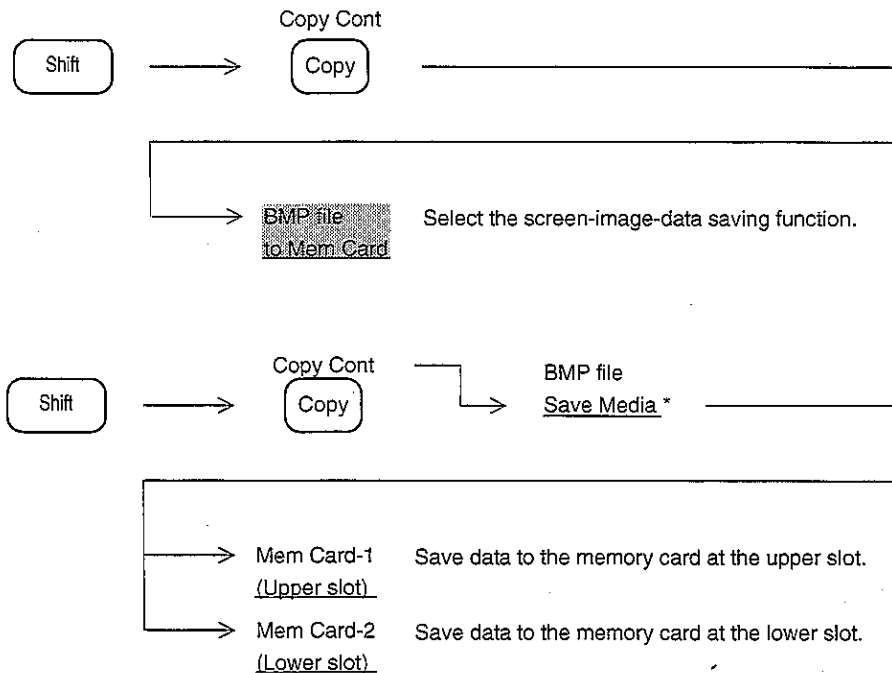

### Executing Save

Saves the screen-image data to a memory card by pressing the **Copy** key. <sup>Copy Cont</sup>

File name to be saved is automatically numbered.

When the menu is displayed in this saving mode, it is also saved as it is.

Use the memory card which is formatted by the spectrum analyzer.

## Executing Save by Specifying File Number

To save the screen-image data to a memory card by specifying a file number to be saved, perform the following key operations..

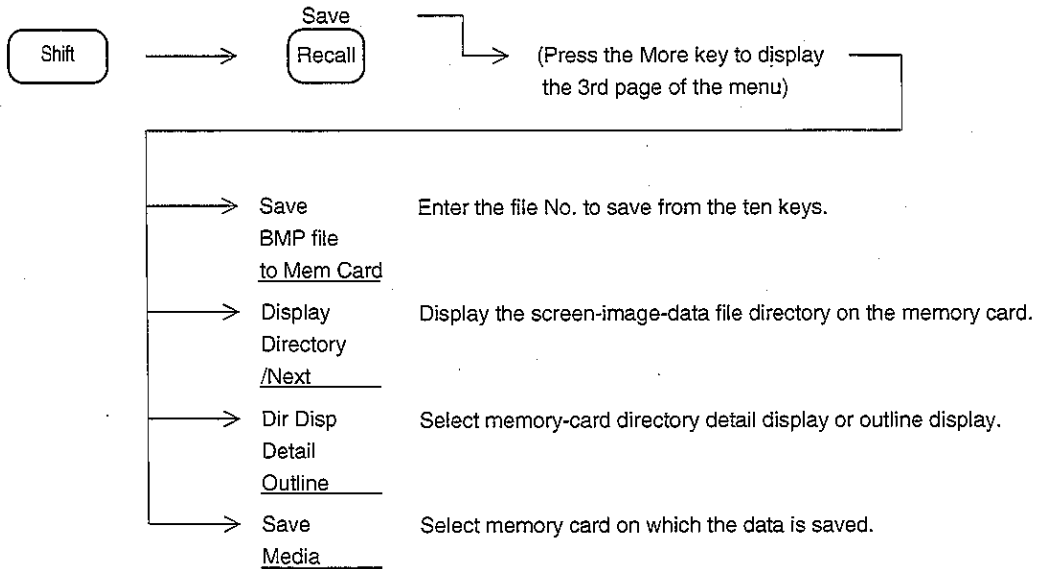

After deleting the menu and data input in this saving mode, only the screen-image-data is saved. Use the memory card which is formatted by the spectrum analyzer..

## Displaying the Screen Image Data on PC

The saved screen image data can be displayed on a personal computer(PC) with a tool on PC (ex. the paint brush of Windows).

The saved files on a memory card are in the directory as shown below.

¥P-2110¥COPY¥COPY001.BMP

↑  
File No.

## Displaying a Title

A character string of up to 19 letters can be displayed in the title display field at the top of the screen. To display a title character string, perform the following key operations.

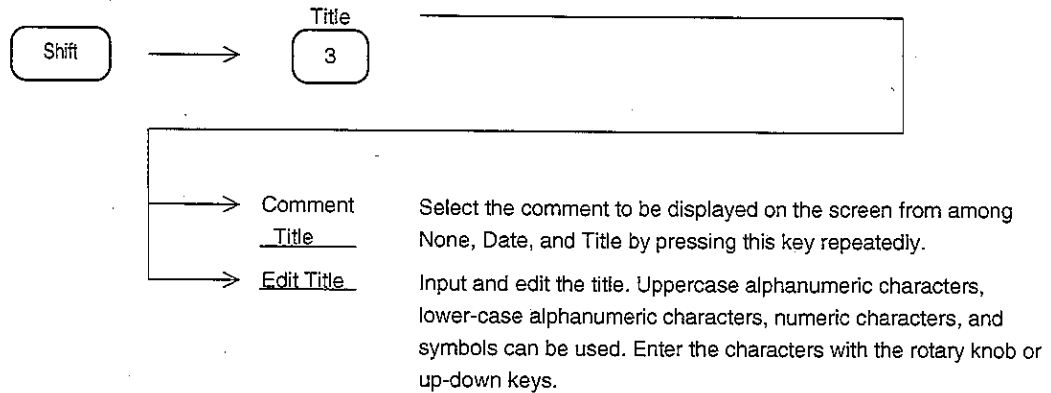

<p>Title: Meas Fre <u>q</u>                      Count On</p> <div style="border: 1px solid black; padding: 5px; margin: 10px 0;"> <p>ABCDEFGHIJKLMNOPQRSTUVWXYZ  abcdefghijklmnopqrstuvwxyz  0123456789-+*/=!°#\$\$%&amp;'()~`  /!@[]{}:;...&lt;&gt;?_</p> </div> <p>Select the characters by turning the rotary knob. After setting the title, press the [Return] key.</p>	<table border="1"> <thead> <tr> <th colspan="2">Edit</th> </tr> </thead> <tbody> <tr> <td style="text-align: center;">←</td> <td>Move Title cursor to the left.</td> </tr> <tr> <td style="text-align: center;">→</td> <td>Move Title cursor to the right.</td> </tr> <tr> <td style="text-align: center;">Insert</td> <td>Insert one character.</td> </tr> <tr> <td style="text-align: center;">Delete</td> <td>Delete one character.</td> </tr> <tr> <td style="text-align: center;">Clear</td> <td>Clear Title.</td> </tr> <tr> <td style="text-align: center;">return</td> <td></td> </tr> </tbody> </table>	Edit		←	Move Title cursor to the left.	→	Move Title cursor to the right.	Insert	Insert one character.	Delete	Delete one character.	Clear	Clear Title.	return	
Edit															
←	Move Title cursor to the left.														
→	Move Title cursor to the right.														
Insert	Insert one character.														
Delete	Delete one character.														
Clear	Clear Title.														
return															

Title Edit Screen

# SOUND Monitor

The spectrum analyzer has a SOUND monitor function which demodulates an AM or FM modulated signal so that the sound can be listened to using the built-in speaker.

To listen to the sound, first set the center frequency to the receiving frequency, then set the display mode to the time domain mode. Second, perform the following key operations, depending on the modulation system.

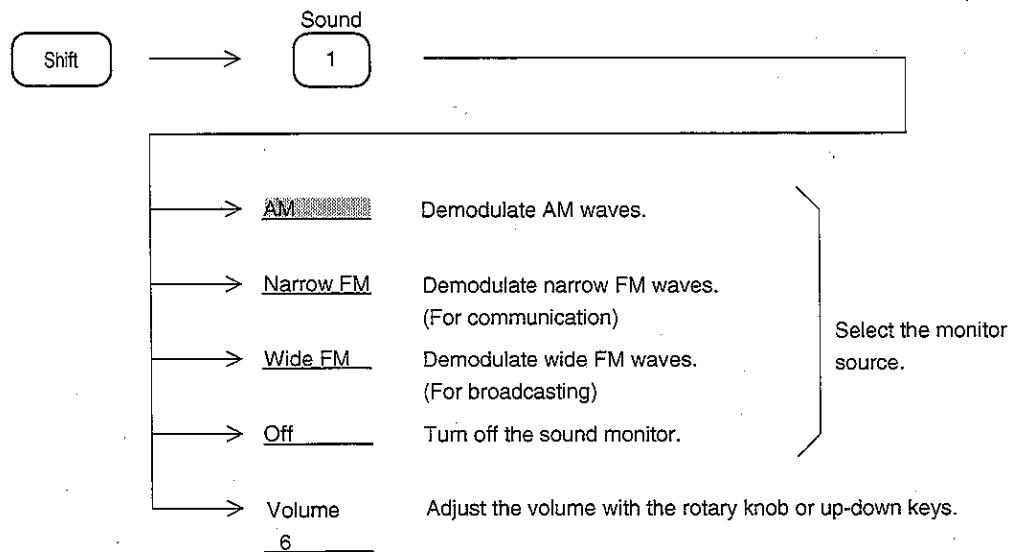

**Note:** In spite of setting the center frequency to the desired receive frequency, the sound may not be able to be monitored, correctly, because of the RBW center-frequency error calibration. In this case, turn off the RBW center-frequency error calibration, as shown below.

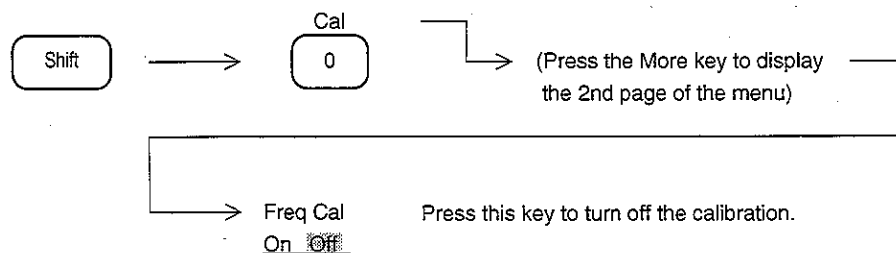

When Freq Cal turned Off, the displayed waveform moves by the error amount. When the Sound Monitor is not used, turn On the Freq Cal.

## AM Wave Sound Monitor

Since the spectrum analyzer is not equipped with the AGC circuit that is used in general AM receivers, the reference level must first be set to the optimum value depending on the receiving level.

In the time domain display (linear scale) mode, set the reference level so that the waveform shown below is displayed.

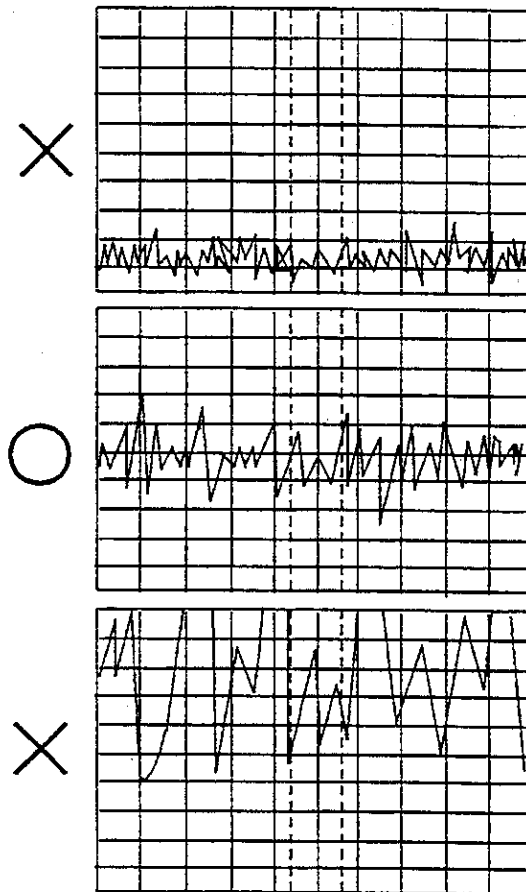

## FM Wave Sound Monitor

An FM wave is different from an AM wave in that the sound output level is not changed by the input level. When compared to the reference level, a too low input level results in deterioration of the S/N ratio. Therefore, the input level should be set so that it is preferably equal to the reference level.

SECTION 11 COPY/SOUND MONITOR

## SECTION 12

### PTA/DEFINE FUNCTIONS

This section describes the PTA function which uses the spectrum analyzer as the controller and the define function which allows definition of PTA automatic measurement program execution, etc. by user key.

#### TABLE OF CONTENTS

PTA Program Editing and Loading .....	12-3
Setting PTA Program .....	12-3
Loading and Executing PTA Program .....	12-4
Loading and Executing Library Program .....	12-5
User-Definition Function .....	12-6
Defining User Menu .....	12-7
Example of User-Definition Operation .....	12-8





# SECTION 12 PTA/DEFINE FUNCTIONS

## PTA Program Editing and Loading

Input and edit the PTA program by external computer editor by PTL language (BASIC-like interpreter). For further details, refer to the operating instructions of the PTA Control part.

Load the edited program to the spectrum analyzer program memory (192 kilobytes) via the RS-232C/GPIB interface or a memory card.

The measurement data can be directly accessed as variables by system variable, system subroutine, and system function.

## Setting PTA Program

To set a PTA program and library, perform the following key operation.

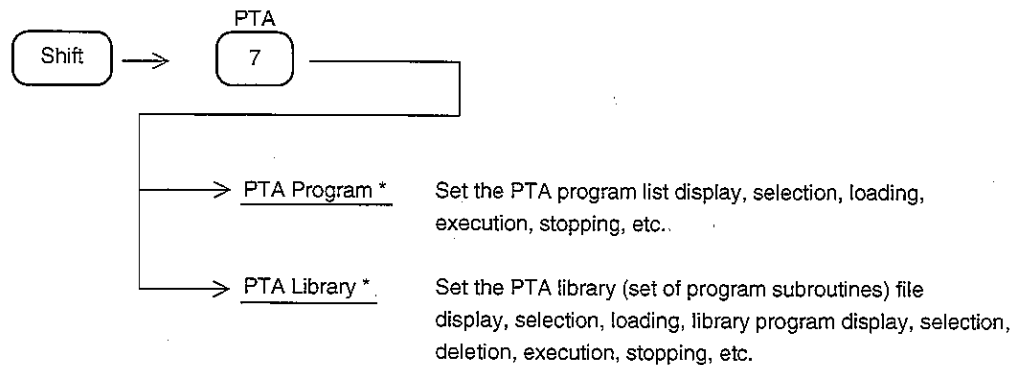

# Loading and Executing PTA Program

To load and execute a PTA program, perform the following key operations.

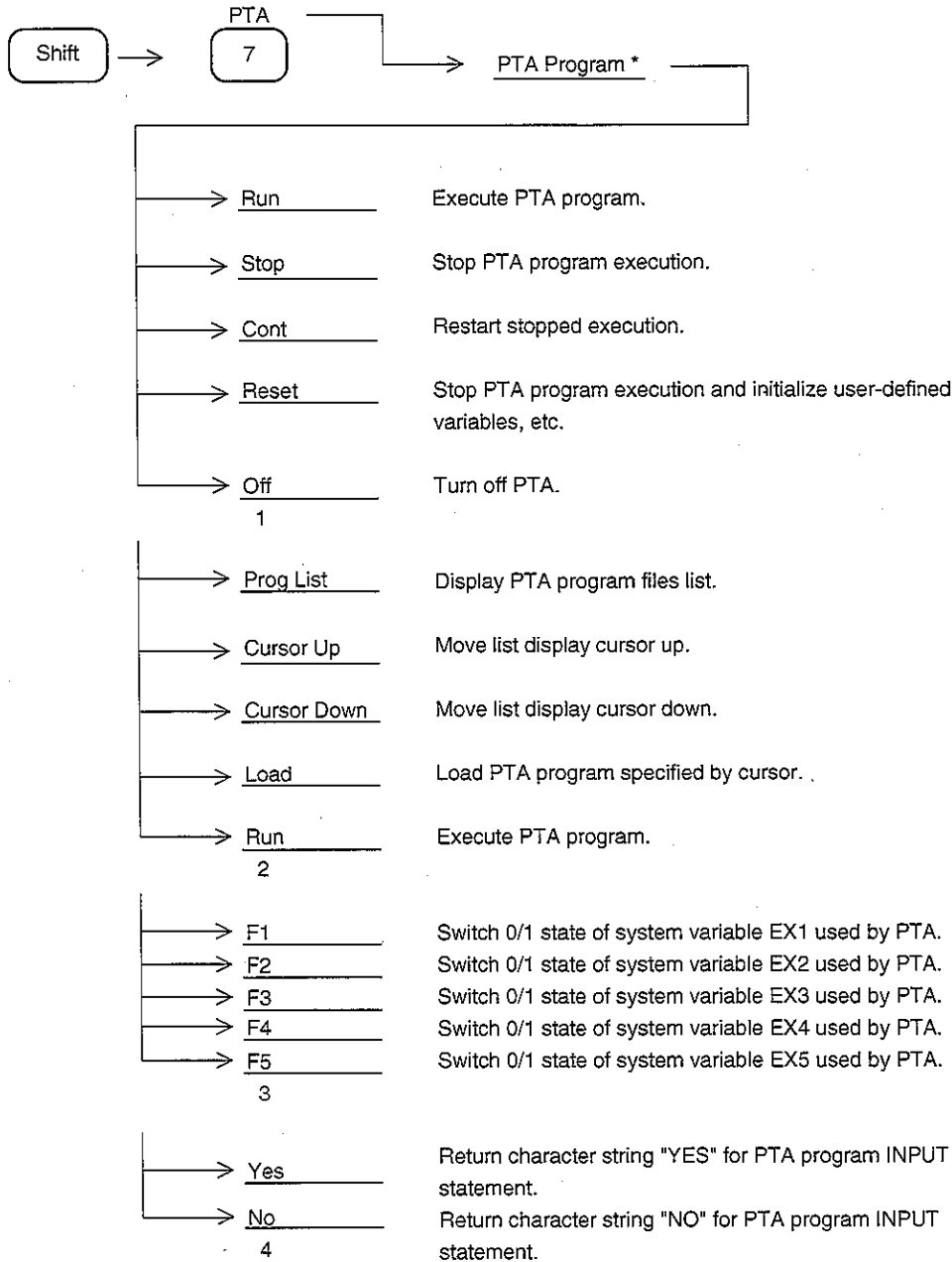

## Loading and Executing Library Program

To load and execute a library program, perform the following key operations.

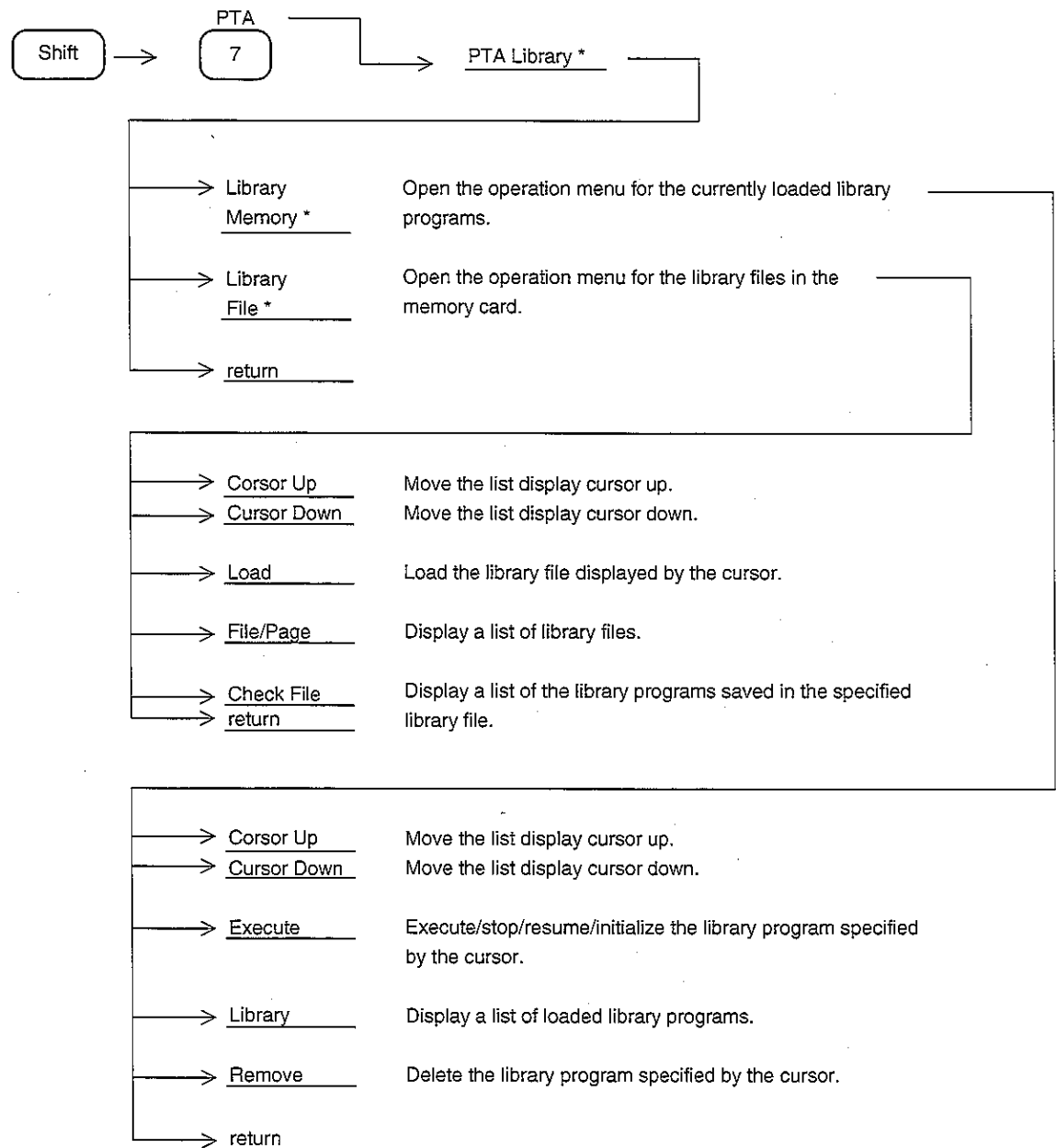

# User-Definition Function

This paragraph describes the define function that allows definition of library program execution or normal key operation, etc. by user key.

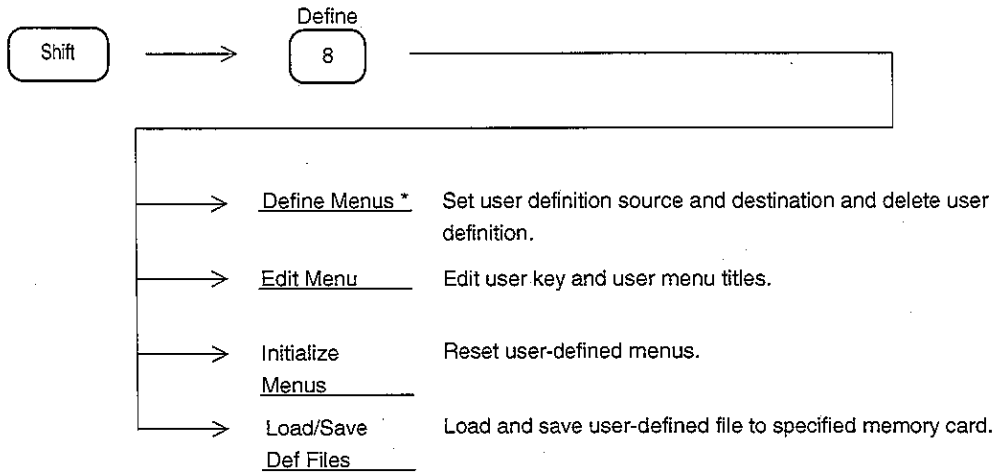

# Defining User Menu

To select the library programs or normal key operations, etc. that are frequently used and to define their function in the user keys, perform the following key operations.

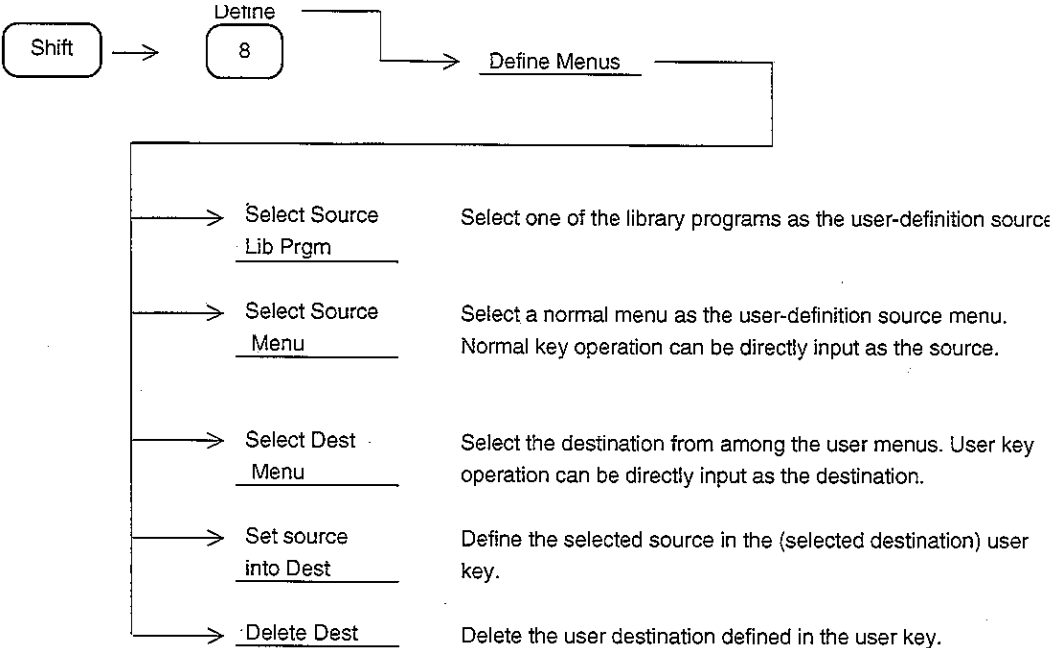

## Example of User-Definition Operation

To define the frequency count measurement function in the User1 F1 key, perform the following key operations.

The following also explains an example of key operation which makes the title of that key "Meas Freq".

- [1] Select the source by " **Shift** **Define** Define Menu Select Source Menu" key operation.
- [2] Set frequency count measurement start at the source by " **Measure** Frequency Count Count On" key operation.
- [3] Select the destination by " **Shift** **Define** Define Menu Select Dest Menu" key operation.
- [4] Set the User1 F1 key as the destination by " **User** **F1** " key operation.

Source	Destination
F1-Key	F1-Key
Freq Count	User-1
Count On	---

User Definition Screen Display

- [5] Execute user key definition by " **Shift** **Define** Define Menu Set source into Dest" key operation.
- [6] Perform " **Shift** **Define** Edit Menu Select Source" key operation and select the User1 F1 key by " **User** **F1** " key operation.

[7] Perform **Shift** **Define** **Edit Menus** **Edit F-key menu** key operation and enter "Meas Freq" at the title edit screen shown below by rotary knob and soft key operation.

<p>Title:Meas Freq</p> <p style="text-align: center;">Count On</p> <div style="border: 1px solid black; padding: 5px; margin: 10px auto; width: 80%;"> <p>ABCDEFGHIJKLMNOPQRSTUVWXYZ</p> <p>abcdefghijklmnopqrstuvwxyz</p> <p>0 1 2 3 4 5 6 7 8 9 - + * / = ! " # \$ % &amp; ' ( ) ~ `</p> <p>/ ! @ [ ] { } : ; , . &lt; &gt; ? _</p> </div> <p>Select the charcters by turning the rotary knob, After setting the title, press the [Return] key.</p>	<table border="1"> <thead> <tr> <th colspan="2">Edit</th> </tr> </thead> <tbody> <tr> <td style="text-align: center;">←</td> <td>Move Title cursor to the left.</td> </tr> <tr> <td style="text-align: center;">→</td> <td>Move Title cursor to the right.</td> </tr> <tr> <td style="text-align: center;">Insert</td> <td>Insert one character.</td> </tr> <tr> <td style="text-align: center;">Delete</td> <td>Delete one character.</td> </tr> <tr> <td style="text-align: center;">Clear</td> <td>Clear Title.</td> </tr> <tr> <td style="text-align: center;">return</td> <td></td> </tr> </tbody> </table>	Edit		←	Move Title cursor to the left.	→	Move Title cursor to the right.	Insert	Insert one character.	Delete	Delete one character.	Clear	Clear Title.	return	
Edit															
←	Move Title cursor to the left.														
→	Move Title cursor to the right.														
Insert	Insert one character.														
Delete	Delete one character.														
Clear	Clear Title.														
return															

Title Edit Screen

[8] Press the **User** key and check if the following is displayed at the F1 function key. Also press the User1 **F1** key and check if frequency measurement is performed.

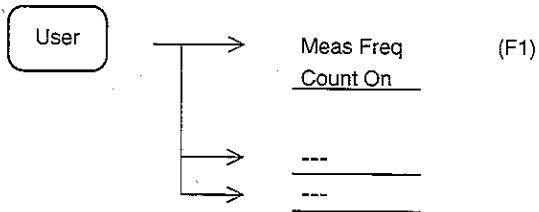

SECTION 12 PTA/DEFINE FUNCTIONS



# SECTION 13

## MEASUREMENT

This section describes the Measure key and the operating procedure for actual measurement examples.

### TABLE OF CONTENTS

Measure Measurement Function .....	13-3
Frequency Measurement Function .....	13-4
Measuring Noise Power .....	13-4
Measuring C/N Ratio .....	13-5
Channel Power .....	13-5
Measuring Occupied Bandwidth .....	13-5
Measuring Adjacent Channel Leakage Power .....	13-6
Pass/Fail Judgment by Mask .....	13-6
Pass/Fail Judgment by Time Template .....	13-7
Measuring Burst Average Power .....	13-7
Measurement Examples .....	13-8
Example of C/N Ratio Measurement .....	13-8
Example of Power (Noise) Measurement (Frequency Domain, Continuous Wave) .....	13-10
Example of Channel Power Measurement (Frequency Domain, Continuous Wave) .....	13-12
Example of Power Measurement (Time Domain) .....	13-14
Example of Time Domain Peak Detection .....	13-17
Example for Occupied Frequency Bandwidth (Burst Wave) .....	13-18
Example of Spurious Radiation Strength Measurement (Burst Wave) .....	13-20
Examples of Carrier-Off Leakage Power Measurement (Time Gate Spectrum Analysis) .....	13-23
Example of Measurement of Adjacent Channel Leakage Power .....	13-28
Example of Memory Card Use .....	13-30
Example of Time Template Creation (PHS Transmit Signal) .....	13-31
MASK Creation in Frequency Domain Mode .....	13-36



# SECTION 13 MEASUREMENT

## Measure Measurement Function

Various application measurements can be selected by performing the following key operations.

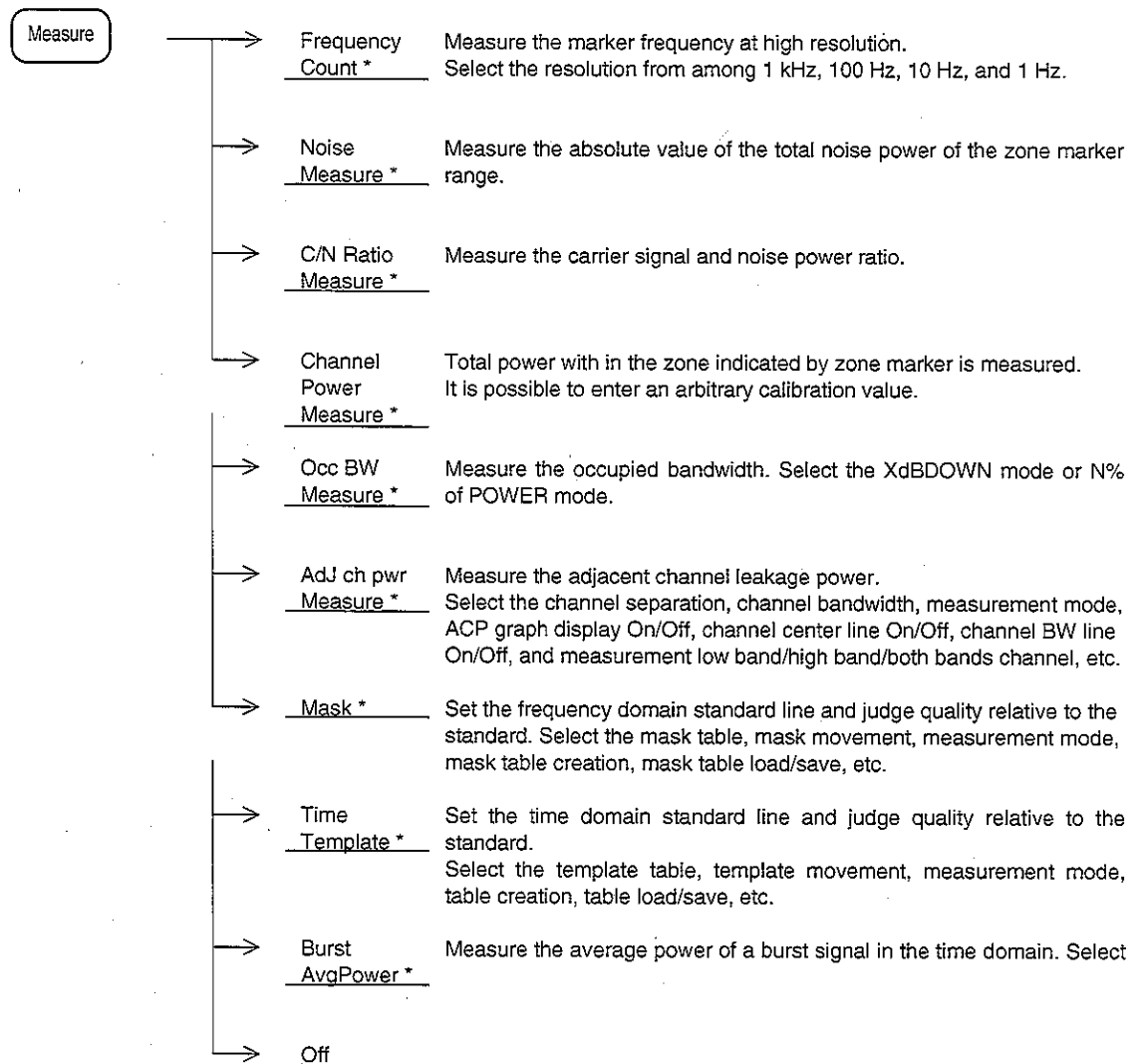

## Frequency Measurement Function

To measure the marker frequency at high resolution, perform the following key operations.

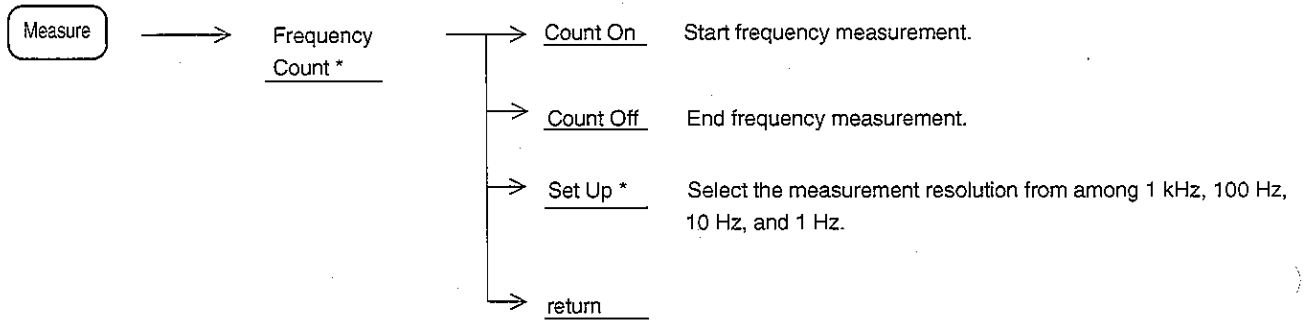

- Note:
- If the RBW is too small compared to frequency span, it takes more times to count because of the internal automatic tuning operation.  
Conversely, if the RBW is too large and another signal exists near the measurement signal (within the 20 multiple of the RBW), the automatic operation may catch it. So, select the appropriate RBW value.
  - In the following cases, the frequency may not be counted correctly because of the undesired adjacent noise.
    - ① Signal level is less than -30 dB from reference level.
    - ② Level difference between signal and noise is less than 20 dB.

## Measuring Noise Power

To measure the total noise power of the zone marker range, perform the following key operations.

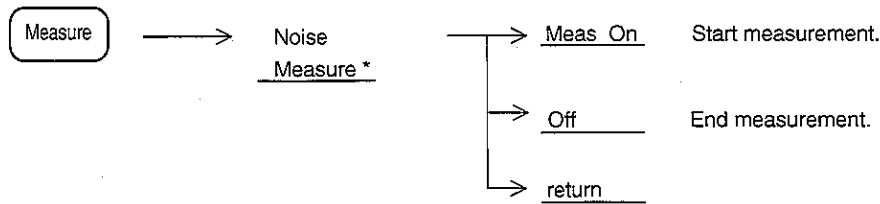

## Measuring C/N Ratio

To measure the C/N ratio, perform the following key operations.

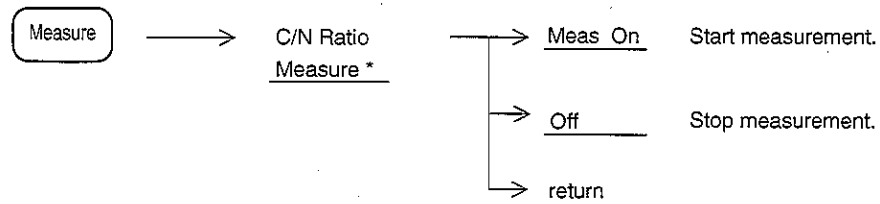

## Channel Power

Total power within the channel specified by zone marker is measured.

It is possible to set an arbitrary calibration value.

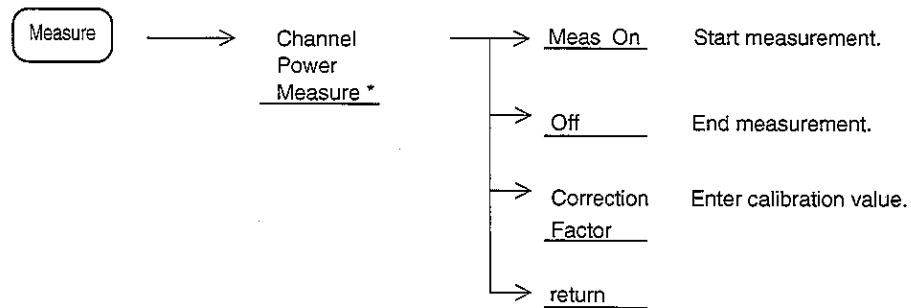

## Measuring Occupied Bandwidth

To measure the occupied bandwidth, perform the following key operations.

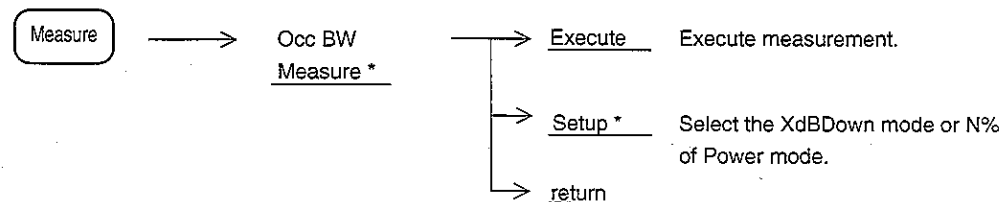

## Measuring Adjacent Channel Leakage Power

To measure the adjacent channel leakage power, perform the following key operations.

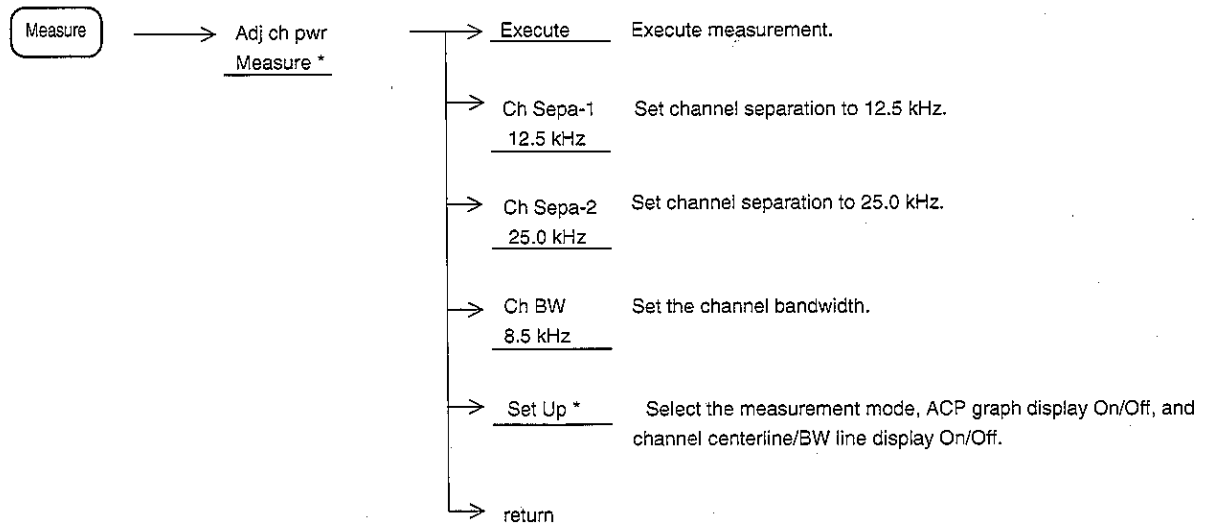

## Pass/Fail Judgment by Mask

To perform pass/fail judgment relative to the frequency domain standard line (mask), perform the following key operations.

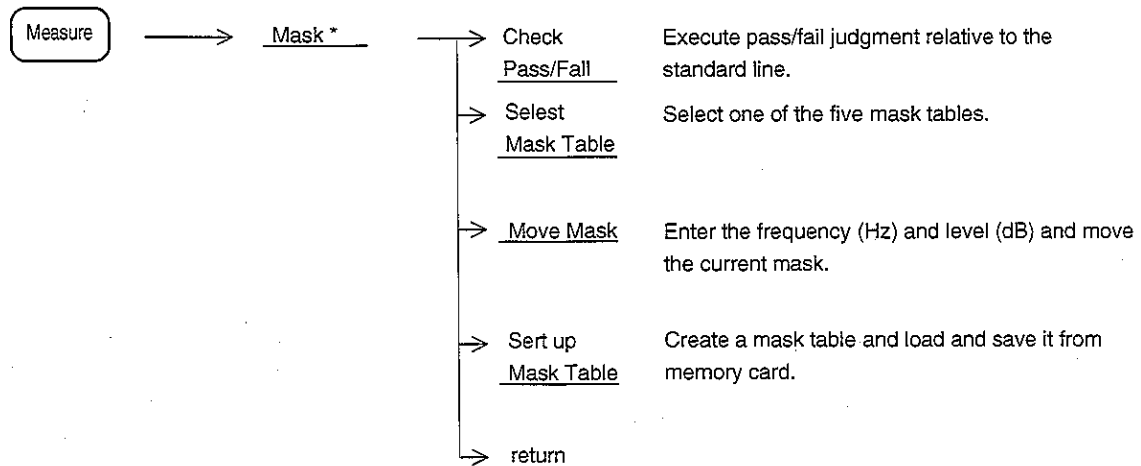

## Pass/Fail Judgment by Time Template

To perform pass/fail judgment by time domain template, perform the following key operations.

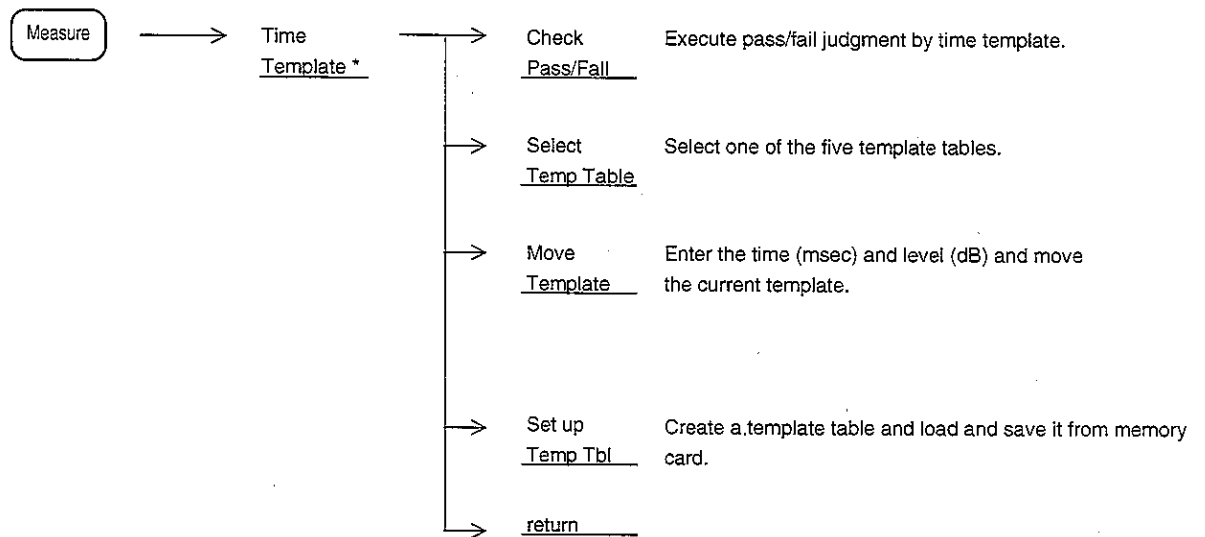

## Measuring Burst Average Power

To measure the average power of a burst wave in the time domain mode, perform the following key operations.

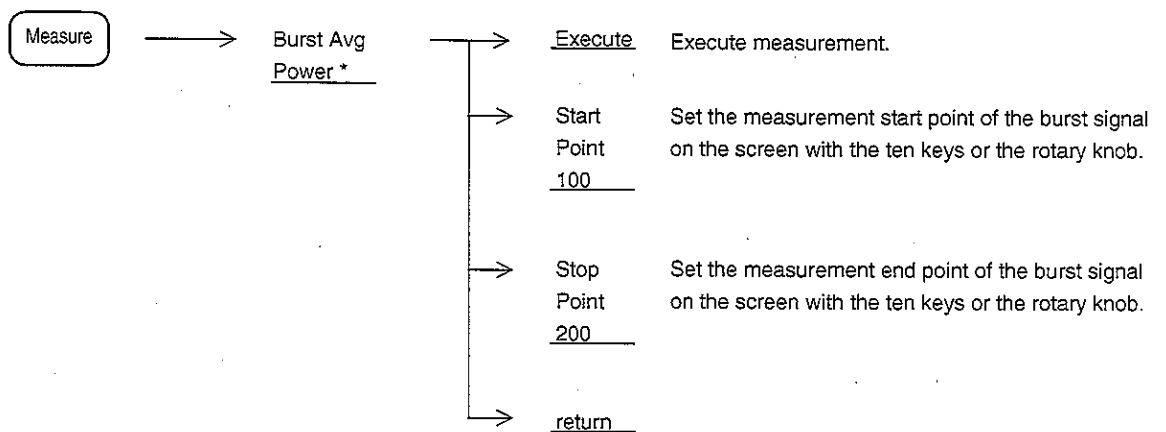

## Measurement Examples

The following describes the measurement block diagram and measurement operating procedure of actual measurement examples.

In the measurement examples, [ ] indicates a panel key and F\*: <<>> indicates a soft key.

### Example of C/N Ratio Measurement

- In C/N measurement, set the detection mode set to the Sample mode, unless specified otherwise. (Pressing [A,B] until F1: <<Trace A>> is displayed, then set the mode by pressing F1: <<Trace A>>, F6: <<Detection>>, and F3: <<Sample>>.)

#### (1) Measurement block diagram

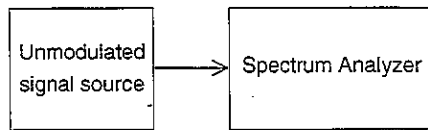

- Center frequency : 1.9 GHz
- Offset frequency : 100 kHz

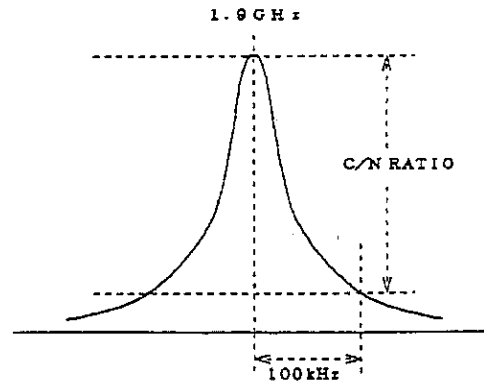

#### (2) Measurement procedure

Step	Procedure
1	[Preset], F1: <<Preset All>>
2	Span frequency setting : [Span], [4], [m], [0], [0], [kHz] Set to 3 or 4 times the offset frequency. (Here, the span frequency was set to 400 kHz.)
3	Reference level setting : [Amplitude], [2], [0], [dBm]
4	Center frequency setting: [Frequency], [1], [.] , [9], [GHz]
5	RBW setting : [RBW], [3], [kHz]
6	Marker setting : [Marker], F5: <<Zone Width>>, F1: <<Spot>>
7	Peak (frequency, level) setting: After 1 sweep, press [→CF] and [→RLV].
8	Marker position setting : [Marker], F2: <<Delta Marker>>, [1], [0], [0], [kHz] (Becomes the offset frequency.)
9	C/N ratio measurement: : Press [Measure] until F3: <<C/N Ratio Measure>> is displayed, then press F3: <<C/N Ratio Measure>> and F1: <<Meas On>>. Each time sweep is re-freshed, the measurement result is displayed at the upper left-hand corner of the screen.



- \* Measurement result example:  $-119.14$  dBc/Hz
- \* When wanting to change the offset frequency and make measurement: Press [Marker], then set the offset frequency with the rotary knob or ten keys.
- \* Change the RBW value and select the best C/N measurement value. Also make the ATT value minimum.

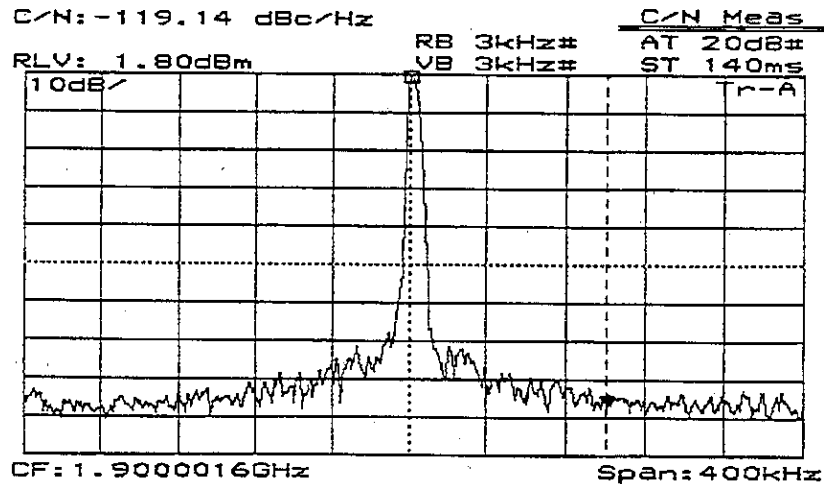

Example of C/N Ratio Measurement

- Note:
- When the marker frequency is moved at the reference marker point (peak point of the carrier signal), the measurement result does not become 0 dB. This is because the carrier signal (on which the reference marker is positioned) is considered as a noise, and the detector adds the correction value to the carrier.

## Example of Power (Noise) Measurement (Frequency Domain, Continuous Wave)

- When making power measurements, set the detection mode to the Sample mode, unless specified otherwise. When measuring the carrier-off leakage power and adjacent channel leakage power of Japan digital cordless telephone systems (burst wave), set the detection mode to the Pos Peak mode.

### (1) Measurement block diagram

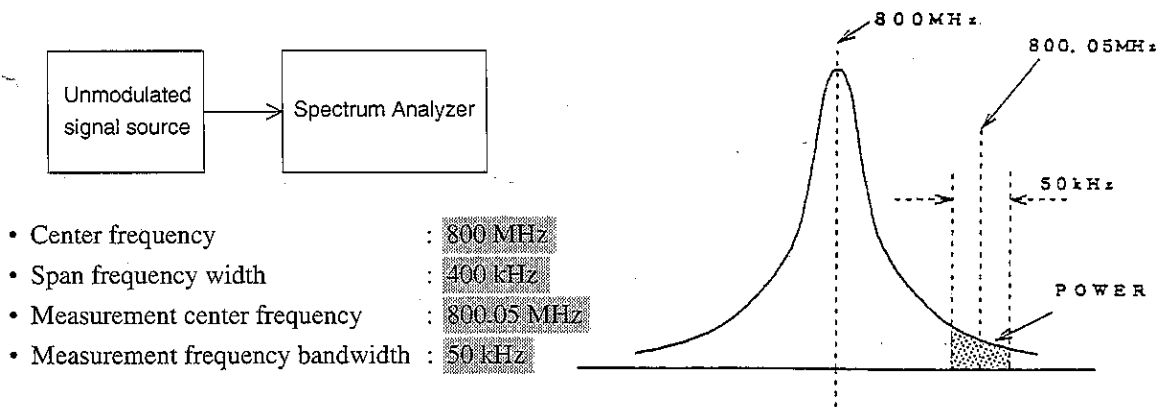

### (2) Measurement procedure

Step	Procedure
1	[Preset], F1: <<Preset All>>
2	Span frequency setting : [Span], [4], [0], [0], [kHz]
3	Reference level setting : [Amplitude], [2], [0], [dBm]
4	Center frequency setting : [Frequency], [8], [0], [0], [MHz]
5	RBW setting : [RBW], [3], [kHz]
6	Peak(frequency, level) setting: After 1 sweep, press [→CF] and [→RLV].
7	Zone center position setting : [Marker], F5: <<Zone Width>>, F1: <<Spot>>, [Marker], F1: <<Normal Marker>>, [8], [0], [0], [.,] [0], [5], [MHz]
8	Zone marker width setting : [Marker], F5: <<Zone Width>>, [5], [0], [kHz]
9	Measure power(noise) : Press [Measure] until F2<< Noise Measurement>> is displayed, then press F2: <<Noise Measure>> and F1: <<Meas On>>. Each time sweep is refreshed, <u>the total power value of the zone marker range</u> (measured value) is displayed at the upper left-hand corner of the screen.

- \* Measurement result example: -70.81 dBm/ch
- \* When wanting to change the zone marker position and make measurements: After pressing [Marker], set the position (frequency) with the ten keys.
- \* Applications:
  - Carrier-off leakage power (PHS) measurement
  - Adjacent channel leakage power (PHS) measurement

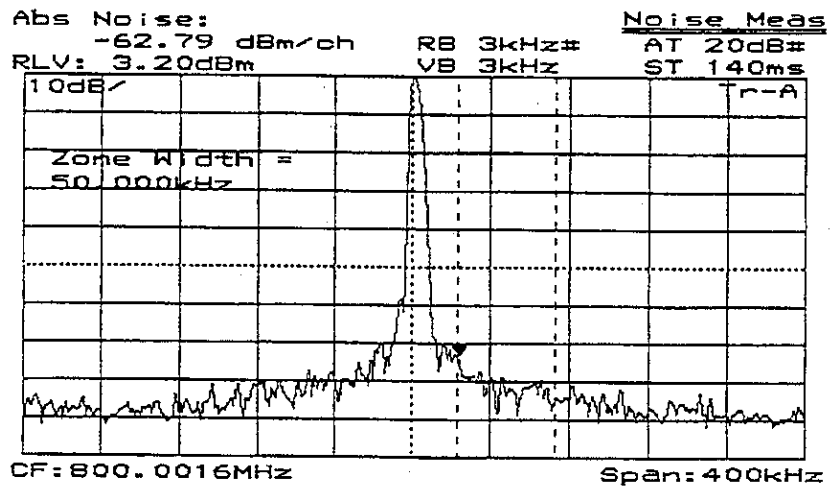

Example of Power (Noise) Measurement

## Example of Channel Power Measurement (Frequency Domain, Continuous Wave)

- When making power measurements, set the detection mode to the Sample mode, unless specified otherwise. When measuring the carrier-off leakage power and adjacent channel leakage power of Japan PHS systems (burst wave), set the detection mode to the Pos Peak mode.

### (1) Measurement block diagram

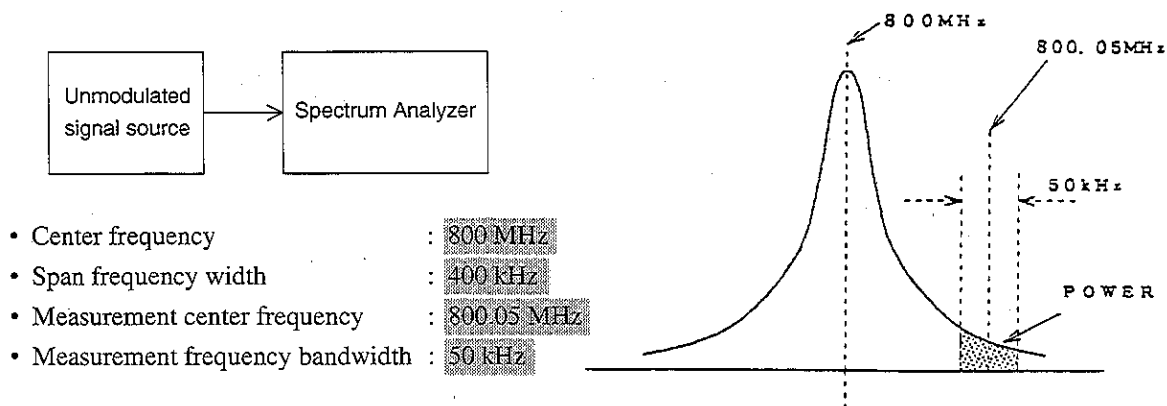

### (2) Measurement procedure

Step	Procedure
1	[Preset], F1: <<Preset All>>
2	Span frequency setting : [Span], [4], [0], [0], [kHz]
3	Reference level setting : [Amplitude], [2], [0], [dBm]
4	Center frequency setting : [Frequency], [8], [0], [0], [MHz]
5	RBW setting : [RBW], [3], [kHz]
6	Peak(frequency, level) setting: After 1 sweep, press [→CF] and [→RLV].
7	Zone center position setting : [Marker], F5: <<Zone Width>>, F1: <<Spot>>, [Marker], F1: <<Normal Marker>>, [8], [0], [0], [.,] [0], [5], [MHz]
8	Zone marker width setting : [Marker], F5: <<Zone Width>>, [5], [0], [kHz]
9	Measure Channel Power : Press [Measure] until F4<< Channel Power measure>> is displayed, then press F4: <<Noise Measure>> and F1; <<Meas On>>.

Each time sweep is refreshed, the total power value of the zone marker range (measured value) is displayed at the upper left-hand corner of the screen.

F5: <<correction factor>> , an arbitrary calibration value can be entered.

- \* Measurement result example:  $-70.81 \text{ dBm}$ ,  $-152.72 \text{ dBm/Hz}$
- \* When wanting to change the zone marker position and make measurements: After pressing [Marker], set the position (frequency) with the ten keys.

## Example of Power Measurement (Time Domain)

- Find the effective average value of the zone set by the two cursors on the screen.

(1) Measurement block diagram

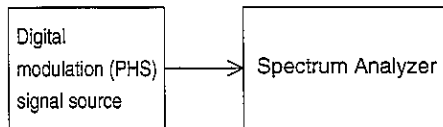

- Center frequency : 1.9 GHz
- Time span : 1 ms

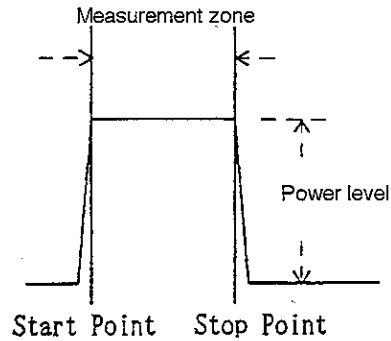

(2) Measurement procedure

Step	Procedure
1	[Preset], F1: <<All>>
2	Time domain : [Time] or [Span], [0], [Hz]
3	Reference level setting : [Amplitude], [2], [0], [dBm]
4	Center frequency setting : [Frequency], [1], [.] , [9], [GHz]
5	RBW setting : [RBW], [1], [MHz]
6	VBW setting : [VBW], [1], [MHz]
7	Time span setting : [Time], F2: <<Time Span>>, [5], [msec]
8	Reference level setting : After one sweep, press [->RLV] and [Amplitude] and raise the reference level about 3 dB with the rotary knob.
9	Time span setting : [Time], F2: <<Time Span>>, [1], [msec]
10	Trigger setting : Select Triggered with [Trig/Gate], F1: <<Trigger>>. F2: <<Trigger Source>>, F1: <<Video>> (Apply <u>video trigger</u> ) Select rise with F5: <<Trig Slope>>. Press F1: <<Trig Level>>, then set the trigger level with the rotary knob.
11	Time delay setting : Press [Trig/Gate], F5: <<Delay Time>>, then set the signal waveform to the left of center of the screen with the rotary knob.

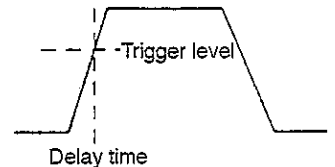

Step	Procedure
12	Single sweep : [Single]
13	Measurement preparation : Press [Measure] until F2: <<Burst Avg Power>> is displayed, then press F2: <<Burst Avg Power>>. Measurement zone setting : Press F3: <<Start Point>>, then set the measurement zone start position with the rotary knob. Press F2: <<Stop Point>>, then set the measurement zone stop position with the rotary knob.
14	Power measurement : F1: <<Execute>>. The measured value is displayed at the top left-hand corner of the screen.

- \* Example of measurement result: -16.84 dBm, 20.7 μW
- \* When finding the average power between burst frames, measurement should be performed by setting the measurement zone to the burst frame time.
- \* Applications:
  - Spurious radiation strength measurement (PDC, PHS)
  - Antenna power measurement (PDC, PHS)

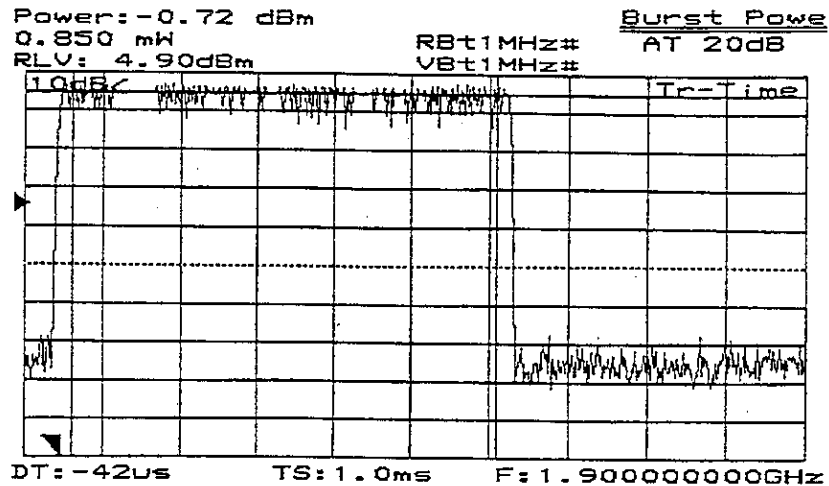
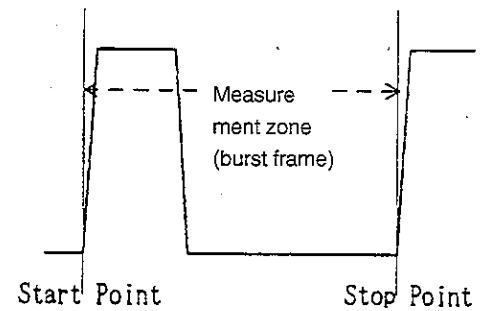

Power Measurement (Time Domain) Example 1

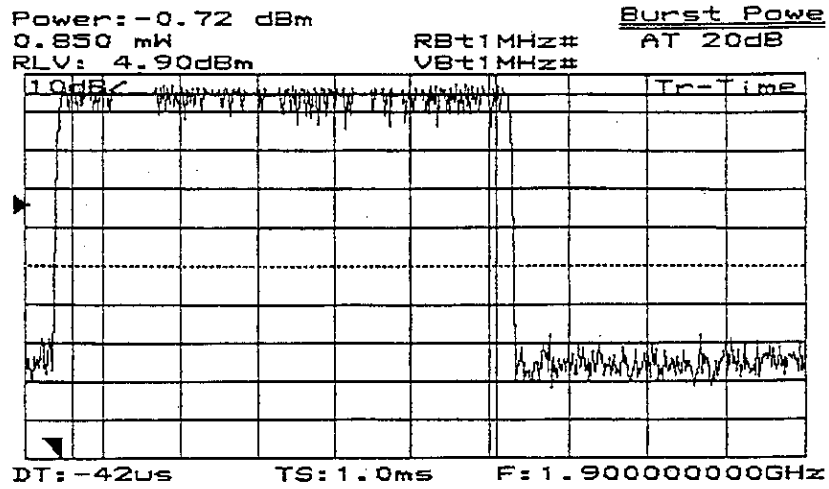

Power Measurement (Time Domain) Example 2



## Example of Time Domain Peak Detection

- The time domain detection mode is initially set to the sample detection mode. When the time axis sweep time was set to more than 20 ms, the positive peak detection mode can be selected.

### (1) Measurement block diagram

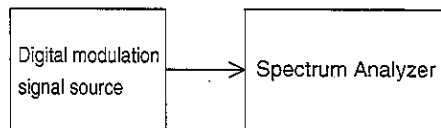

- Center frequency : 1.9 GHz
- Time span : 20 ms

### (2) Measurement procedure

Step	Procedure
1	Set in accordance with steps 1 to 9 of the power measurement procedure of paragraph 5 Power Measurement (Time Domain). Set <<Time Span>> of step 7 to 20 ms.
2	DET MODE menu display : Press [Time] until F6: <<Detection>> is displayed. Select F6: <<Detection>>, F2: <<Pos Peak>>.

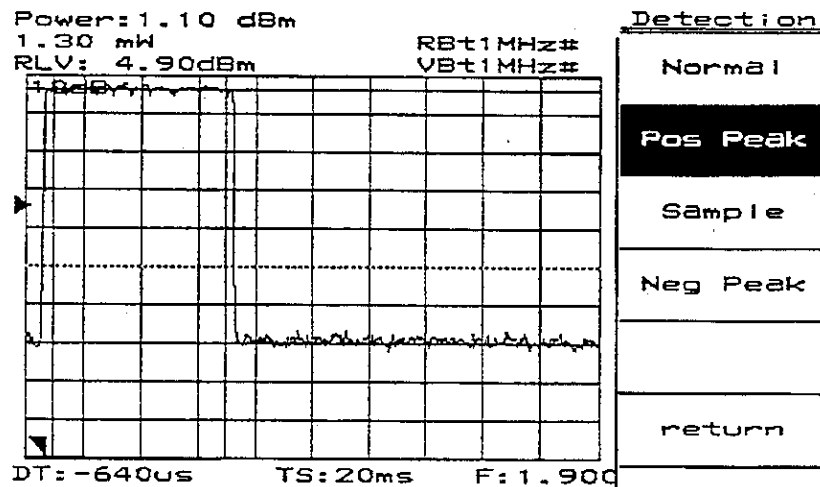

Example of Positive Peak Detection Mode

## Example for Occupied Frequency Bandwidth (Burst Wave)

- For burst waves, set the detection mode to the Pos Peak mode.

### (1) Measurement block diagram

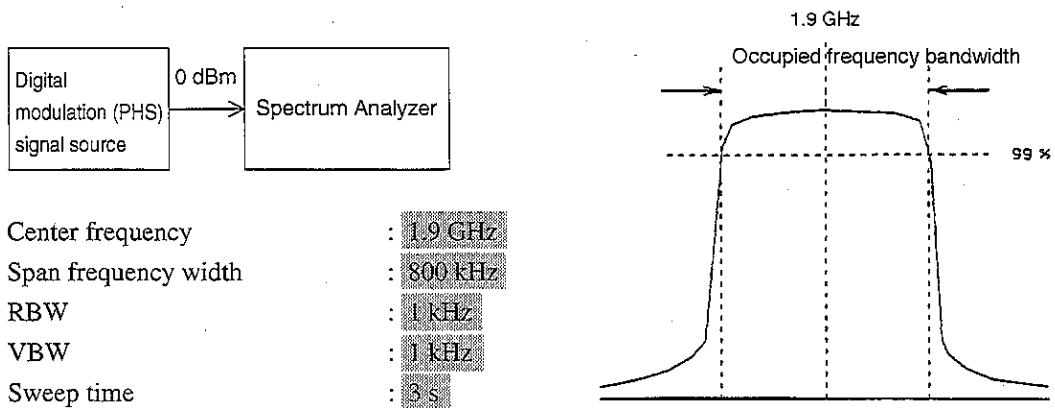

### (2) Measurement procedure

Span	Procudere
1	[Preset], F1: <<Preset All>>
2	Span frequency setting : [Span], [8], [0], [0], [kHz]
3	Reference level setting : [Amplitude], [0], [dBm]
4	Center frequency setting : [Frequency], [1], [.] , [9], [GHz]
5	RBW setting : [RBW], [1], [kHz]
6	VBW setting : [VBW], [1], [kHz]
7	Sweep time setting : [Sweep Time], [3], [s]
8	Single sweep : [Sweep]
9	Measurement preparation : Press [Measure] until F1: <<Occ BW Measure>> is displayed, then press F1: <<Occ BW Measure>>.
10	99% method setting : Select N% of Pwr with F5: <<Setup>>, F1: <<Method>>. F2: <<N% Ratio>>, [9], [9], [Enter]
11	Occupied frequency bandwidth method: F6: <<Return>>, F1: <<Execute>>. The measured value is displayed at the top left-hand corner of the screen.

- \* Example of measurement result: OccBW: 245 kHz, CTR: 1.899996 GHz
- \* Application: Occupied frequency bandwidth (PDC, PHS, etc.)

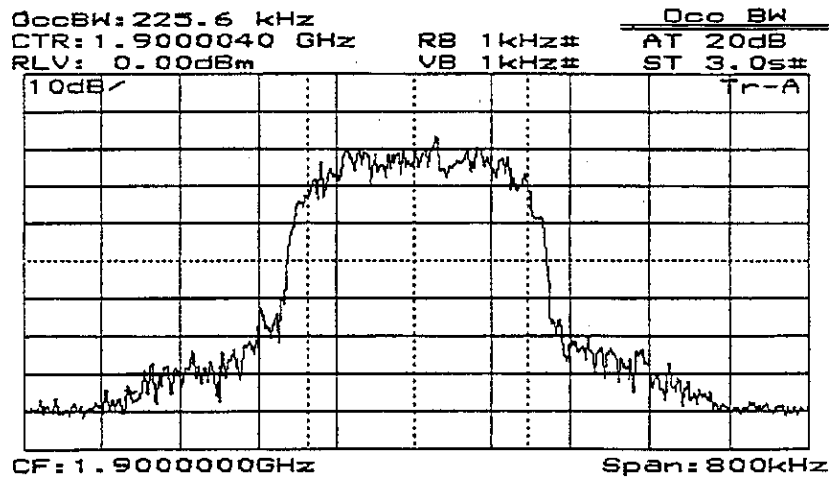

Example of Occupied Frequency Bandwidth Measurement

## Example of Spurious Radiation Strength Measurement (Burst Wave)

- For burst waves, set the detection mode to the Pos Peak mode.

### (1) Measurement block diagram

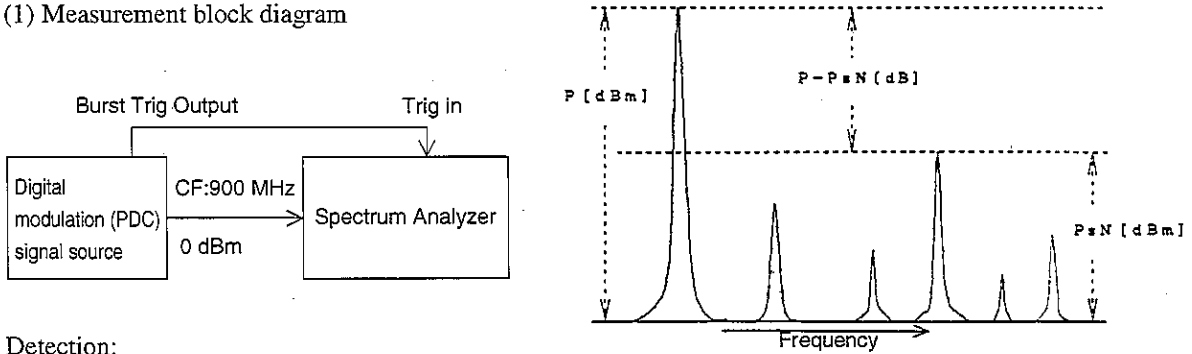

#### Detection:

- Sweep frequency range : 10 MHz to 3 GHz
- RBW : 1 MHz
- VBW : 1 MHz
- Sweep time : 60 s

#### Power measurement:

- Span frequency width : 0 Hz
- RBW : 100 kHz
- VBW : 10 kHz
- Sweep time : 20 ms

### (2) Measurement procedure

Step	Procedure
(A) Spurious detection	
1	[Preset], F1: <<Preset All>>.
2	Sweep frequency range setting : [Frequency], F3: <<Start Freq>>, [1], [0], [MHz], F3: <<Stop Freq>>, [3], [GHz]
3	Reference level setting : [Amplitude], [5], [dBm]
4	RBW setting : [RBW], [1], [MHz]
5	VBW setting : [VBW], [1], [MHz]
6	Sweep time setting : [Sweep Time], [6], [0], [s]
7	Single sweep : [Single]

Step	Procedure
8	Multimarker setting : [Shift], [Marker] (Multi Mkr), F2: <<Highest 10>>, F5: <<Marker List>>. Main and spurious lists (frequency and level of each) are displayed.
	(B) Spurious radiation strength measurement (Example: Assume that the frequency obtained from the list is 1.8 GHz.)
9	Time domain: [Marker], F3: <<Marker Off>>, [Time]  <u>The following measures the power by the same procedure as power measurement (time domain).</u>
10	Center frequency setting : [Frequency], [1], [.] , [8], [GHz]
11	RBW setting : [RBW], [1], [0], [0], [kHz]
12	VBW setting : [VBW], [1], [0], [kHz]
13	Press pressing : [Time] until F2: <<Time Span>> is displayed, then press F2: <<Time Span>>, [2], [0], [ms].
14	Trigger setting : Select Triggered with [Trig/Gate], F1: <<Trigger>>. Select Rise with F2: <<Trigger Slope>>, F3: <<External>>, F1: <<-10 to 10V>>, F5: <<Trig Slope>>. F4: <<Trig Level>>, [2], [V]
15	Press : [Trig/Gate], F5: <<Delay Time>>, then set Delay Time with the rotary knob so that the signal waveform moves to the left of center of the screen.
16	Single sweep : [Single]
17	Measurement preparation : Press [Measure] until F2: <<Burst Avg Power>> is displayed, then press F2: <<Burst Avg Power>>.
18	Measurement zone setting : Press F3: <<Start Point>>, then set the measurement zone start position with the rotary <u>knob</u> . Press F4: <<Stop Point>>, then set the measurement zone stop position with the rotary <u>knob</u> .
19	Power measurement : F1: <<Execute>>. The measured value ( $P_{SN}$ ) is displayed at the top left-hand corner of the screen.

\*Example of measurement result: -57.05 dBm, 1.97  $\mu$ W

Step	Procedure
	(C) Spurious ratio strength ratio (relative to carrier power)
20	Set the center frequency to the carrier frequency and measure the carrier power (P) by executing steps 15, 16, 17, and 18.

Spurious radiation strength ratio:  $(P_{SN}) - (P)$  [dB]

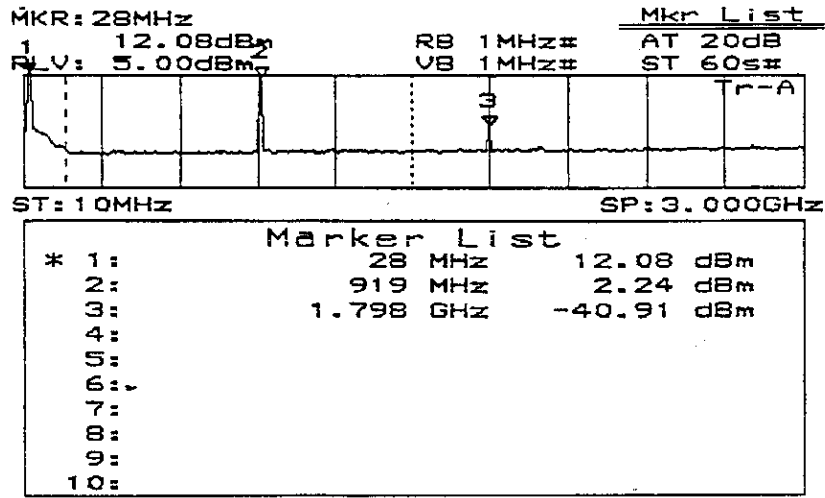

Example of Spurious Detection

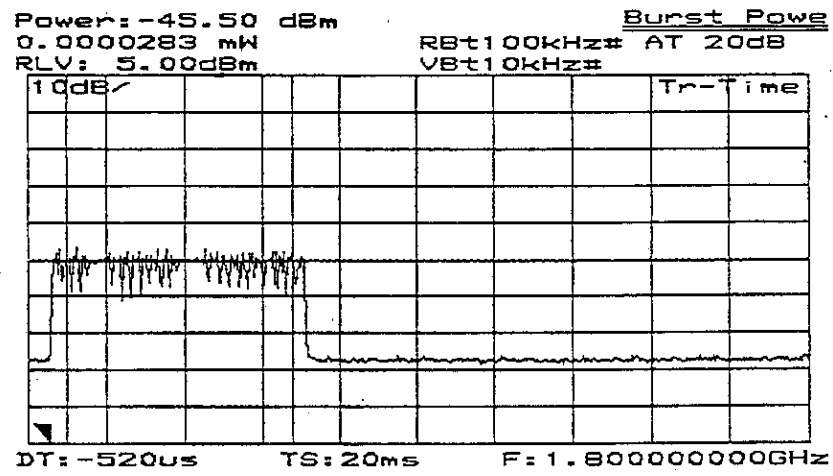

Example of Spurious Strength measurement

## Examples of Carrier-Off Leakage Power Measurement (Time Domain Spectrum Analysis)

Example 1 When external trigger used

- Set the detection mode to the Pos Peak mode.

(1) Measurement block diagram

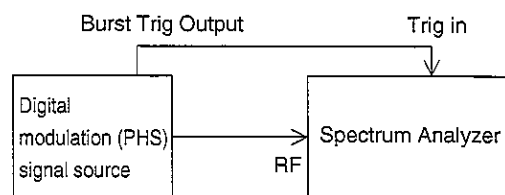

- Input signal frequency : 1.9 GHz
- Center frequency : 1906.55 MHz
- Span frequency width : 24 MHz
- RBW : 300 kHz
- VBW : 3 MHz
- Sweep time : 4 s

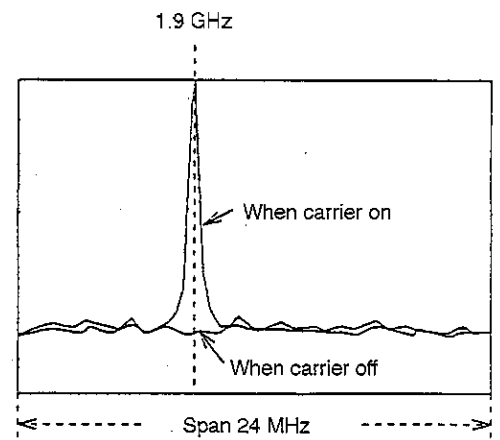

(2) Measurement procedure

Step	Procedure
1	[Preset], F1: <<Preset All>>
2	Time domain setting : [Time]
3	Reference level setting : [Amplitude], [2], [0], [dBm]
4	Center frequency setting : [Frequency], [1], [1], [9], [GHz]
5	RBW setting : [RBW], [1], [MHz]
6	VBW setting : [VBW], [1], [MHz]
7	Time domain setting : [Time], F2: <<Time Sweep>>, [5], [msec]
8	Reference setting : After one sweep, press [→ RLV].
9	Trigger setting : Select Triggered with [Trig/Gate], F1: <<Trigger>> and select Rise with F2: <<Trigger Source>>, F3: <<External>>, F4: <<Trig Level>>, [2], [V]

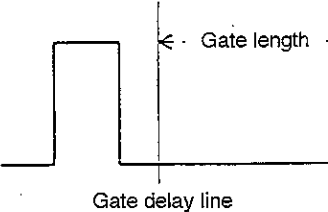
Step	Procedure
10	RBW setting : [RBW], [3], [0], [0], [kHz]
11	VBW setting : [VBW], [3], [MHz]
12	Gate setting : Press [Trig/Gate] until F1: <<Gate Sweep> is displayed. Select On with F1: <<Gate Sweep>>. F2: <<Gate Setup>>, F1: <<Gate Delay>>, and set the gate delay line to the carrier-off region with the rotary knob. F2: <<Gate Length>>, and set the gate length as shown at the right.
	
13	Span frequency setting : [Span], [2], [4], [MHz]
14	Center frequency setting : [Frequency], [1], [9], [0], [6], [.] , [5], [5], [MHz]
15	Sweep time setting : [Sweep Time], [4], [s], [Single]
	(A) Carrier-off leakage power value P(OFF)
16	Multi Mkr setting : [Shift], [Marker] (Multi Mkr), F2: <<Highest 10>>, F5: <<Marker List>> A carrier-off leakage power list (frequency and level of each) is displayed. At this time, if the message "Can not search" is displayed, press [Peak Search].
	*Example of measurement result: -82.57 dBm
	(B) Carrier-on leakage power value P(ON)
17	Turn off the gate : Press [Trig/Gate] until F1: <<Gate Sweep>> is displayed. Select Off with F1: <<Gate Sweep>, then press [Single].
18	Marker setting : [Peak Search] The power when the carrier is on is displayed.
	*Example of measurement result: -15.57 dBm.
	Carrier off/on power ratio: $P(L)-P(O)$



## Example 2 When Wide IF Video trigger used

- Set the detection mode to the Pos Peak mode.

## (1) Measurement block diagram

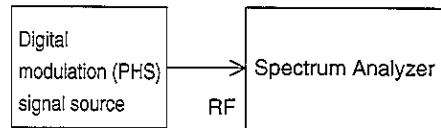

- Input signal frequency : 1.9 GHz
- Center frequency : 1906.55 MHz
- Span frequency width : 24 MHz
- RBW : 300 kHz
- VBW : 3 MHz
- Sweep time : 4 s

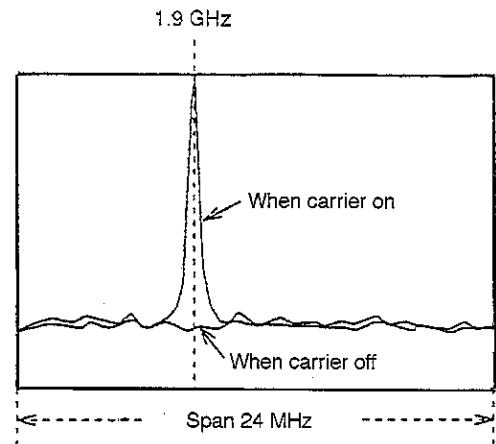

## (2) Measurement procedure

Step	Procedure
1	Select Independent with [Preset], F1: <<Preset All>>, [Shift], [1] (System), F1: <<Couple>>.
2	Reference level setting : [Amplitude], [2], [0], [dBm]
3	Center frequency setting : [Frequency], [1], [.] , [9], [GHz]
4	RBW setting : [RBW], [1], [MHz]
5	VBW setting : [VBW], [1], [MHz]
6	Time span setting : [Time], F2: <<Time Span>>, [5], [ms]
7	Reference level setting : After 1 sweep, press [→RLV].
8	Trigger setting : Select Triggered with [Trig/Gate] and F1: <<Triggered>> and set to the level at which the trigger is to be applied by changing F1: <<Trigger Level>> to High, Middle, or Low. (Use Low as much as possible.)
9	RBW setting : [RBW], [3], [0], [0], [kHz]
10	VBW setting : [VBW], [3], [MHz]

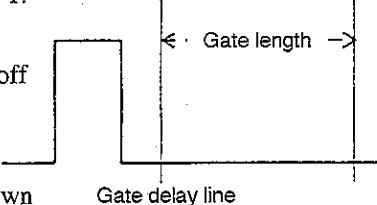
Step	Procedure
11	<p>Gate setting : Press [Trig/Gate] until F1: &lt;&lt;Gate Sweep&gt;&gt; is displayed.            Select On with F1: &lt;&lt;Gate Sweep&gt;&gt;.            Press F2: &lt;&lt;Gate Setup&gt;&gt;, F1: &lt;&lt;Gate Delay&gt;&gt; and set the gate delay line to the carrier-off region with the rotary knob.            Press F2: &lt;&lt;Gate Length&gt;&gt; and set the gate length as shown in the figure at the right with the rotary knob.</p> 
12	Span frequency setting : [Span], [2], [4], [MHz]
13	Center frequency setting : [Frequency], [1], [9], [0], [6], [.] , [5], [5], [MHz]
14	Sweep time setting : [Sweep Time], [4], [s]
(A) Carrier-off leakage power value P(L)	
15	<p>Multimarker setting : [Shift], [Marker] (Multi Mkr), F2: &lt;&lt;Highest 10&gt;&gt;, F5: &lt;&lt;Marker List&gt;&gt; A carrier-off leakage power list (each frequency and level) is displayed. At this time, if the message "Can not search" is displayed, press [Peak Search].</p> <p>*Example of measurement result: -82.57 dBm</p>
(B) Carrier-on leakage power value P(ON)	
16	<p>Turn off the gate : Press [Trig/Gate] until F1: &lt;&lt;Gate Sweep&gt;&gt; is displayed.            Select Off with F1: &lt;&lt;Gate Sweep&gt;&gt;, then press [Single].</p>
17	Marker setting : [Peak Search] The power when the carrier is on is displayed.
	*Example of measurement result: -15.57 dBm
	Carrier off/on power ratio: P(L)-P(O)

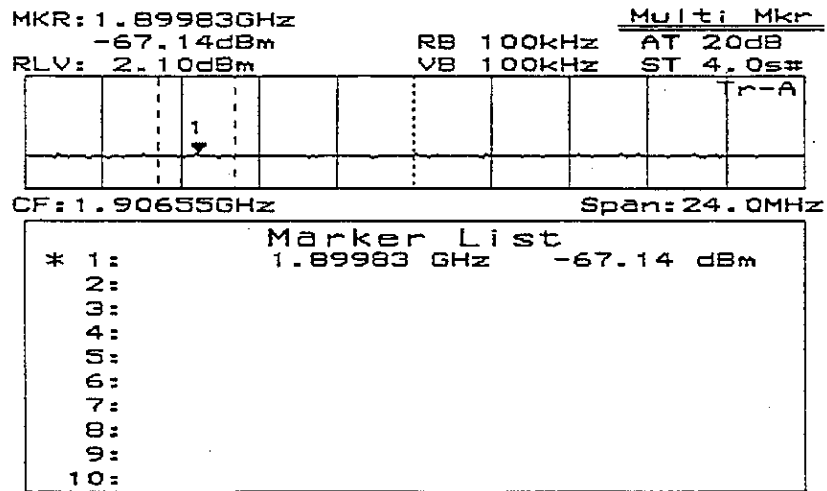

Example of Carrier-Off Leakage Power P(L) Measurement

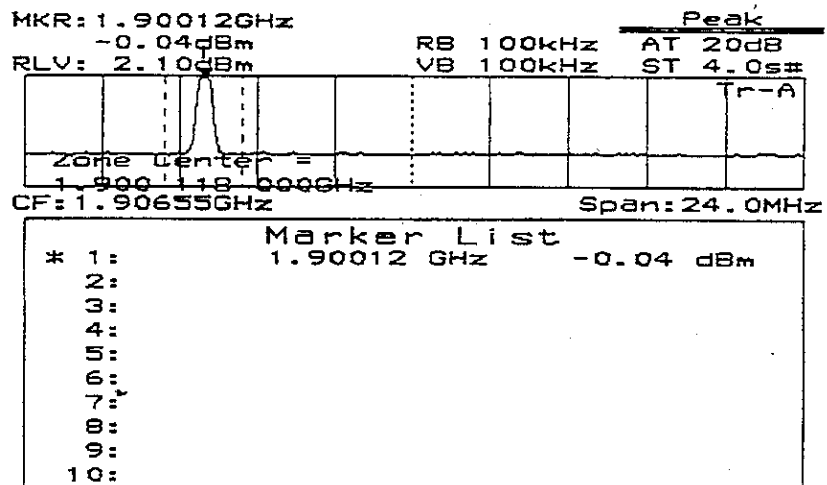

Example of Carrier-On Leakage Power P(O) Measurement

## Example of Measurement of Adjacent Channel Leakage Power

### (1) Measurement block diagram

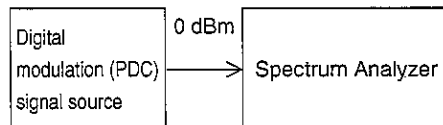

- Center frequency : 900 MHz
- Span frequency width : 250 kHz
- RBW : 1 kHz
- VBW : 3 kHz
- Sweep time : 10 s

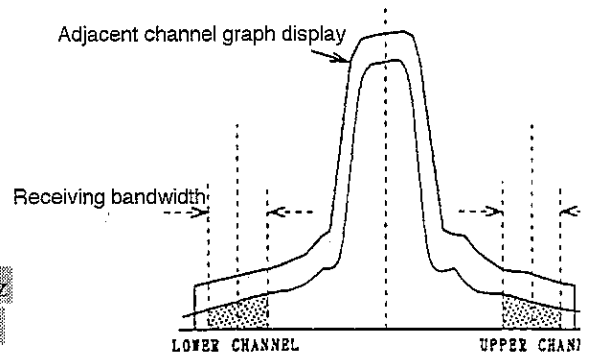

### (2) Measurement procedure

Step	Procedure
1	[Preset], F1: <<Preset All>>
2	Span frequency setting : [Span], [2], [5], [0], [kHz]
3	Center frequency setting : [Frequency], [9], [0], [0], [MHz]
4	RBW setting : [RBW], [1], [kHz]
5	VBW setting : [VBW], [3], [kHz]
6	Reference level setting : [Amplitude], [0], [dB]
7	Sweep time setting : [Sweep Time], [1], [0], [s]
8	ATT setting : Press [ATTEN], then set to the minimum value with the rotary knob.
9	Single sweep : [Single]
10	Measurement preparation : Press [Measure] until F2: <<Adj Ch Pwr Measure>> is displayed, then press F2: <<Adj Pwr Measure>>.
11	Adjacent channel setting : F2: <<Ch Sepa-1>>, [5], [0], [kHz] F3: <<Ch Sepa-2>>, [1], [0], [0], [kHz] (*1)
12	Receiving bandwidth setting: F4: <<Ch BW>>, [2], [1], [kHz]

Step	Procedure
13	Method of calculation : Select Total Pwr or Ref Level or Inband with F5: <<Setup>>, F1 to F3 <<Method>>. (*2)
14	Graph display : On page 2 of <<set up>> when On is selected with F1: <<ACP Graph>>, graph display is performed.
15	Channel display method : When On is selected with F2: <<Ch Center Line>>, a line which indicates the adjacent frequency center frequency is displayed. When On is selected with F3: <<Ch BW Line>>, a line which indicates the adjacent channel bandwidth is displayed. When On is selected with F4:<<Inband BW Line>>, a line which indicates the Inband is displayed.
16	Measurement channel setting: [More], F1: <<Both Channel>>, F6: <<return>>
17	Measurement: F1 : <<Execute>> The measured value is displayed at the top left-hand corner of the screen.

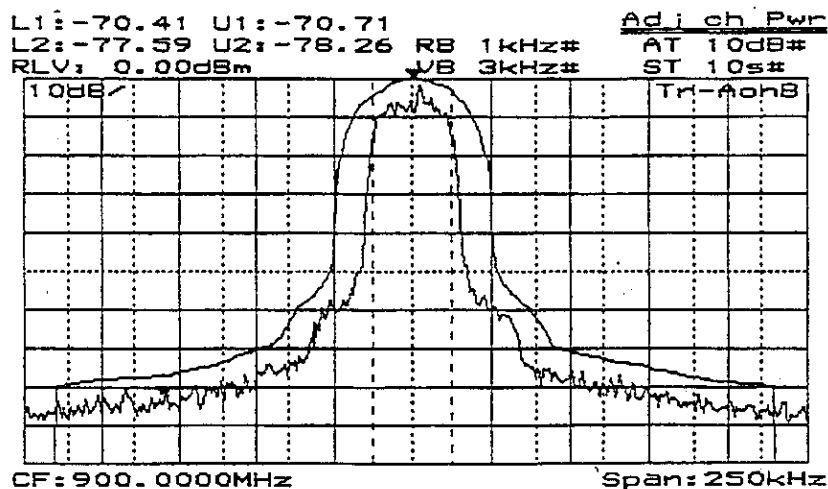

Example of Adjacent Channel Leakage Power Measurement

Note:

- \*1 Reference channel center-In total power method and Inband method, this is defined as the center of zone marker.  
In Reference level method, the display's center is defined as reference channel center.
- \*2 The reference value for each of the calculation method is defined as below.  
Total Power method: The total power of entire waveform displayed.  
Ref Level method: The reference level value of the display.  
Inband method: The total power in the "Inband" defined with marker zone center as reference channel center.

## Example of Memory Card Use

If the measurement screen is stored in a memory card, the same measurement can be performed later by recalling the stored measurement screen. This eliminates troublesome setting of the measurement parameters each time and prevents setting errors. It is designed especially to shorten the measurement time when the setting operation is complex.

Storage method (Assume that the DATA number is 20.)

- 1) Measurement screen single sweep: [Single]
- 2) Press [Shift], [Recall] (save), [More] until F1: <<Save to Mem Card>> is displayed, then press F1: <<Save to Mem Card>>, [2], [0], [Enter].

This completes saving of the screen parameters to Memory Card 20.

Recalling method (Assume that the DATA number is 20.)

- 1) Stored screen display : Press [More] until [Recall], F1: <<Recall from Mem Card>> is displayed, then press F1: <<Recall from Mem Card>>, [2], [0], [Enter].
- 2) Continuous sweep : [Continuous]

## Example of Time Template Creation (PHS Transmit Signal)

### 1) Burst wave screen setting (time domain)

Time span : 1 ms  
 Trigger : -200  $\mu$ s  
 RBW : 1 MHz  
 VBW : 1 MHz  
 RLV : +15 dBm

### 2) Template data overwrite method

- Template scale number setting (No. 1 here):  
 Press [Time], [Measure] until F1: <<Time Template>> is displayed, then press F1: <<Time Template>>, F5: <<Setup Temp Table>>, F1: <<Select Temp Table>>, F1: <<Temp-1>>, F6: <<return>>.
- Data write preparation: Select Relative with F2: <<Level>>.  
 F3: <<Make Up Temp Table>>, [More], F2: <<Select Line>>, F1: <<Limit1 Upper>>, F6: <<return>>, [More] (Here, Limit1 Upper is specified.)
- Data write: Sequentially write the coordinates (time, level) of the template to be created in ascending order of time value.  
 Write data by alternately repeating time setting and level setting.
  - \* Time setting (example: -200  $\mu$ s) : [+/-], [2], [0], [0], [ $\mu$ s]
  - \* Level setting (example: -65 dB) : [+/-], [6], [5], [dB]
- Limit1 Lower write: Press [More], F2: <<Select Line>>, F2: <<Limit 1 Lower>>, F6: <<return>>, [More], then write the template coordinate data.

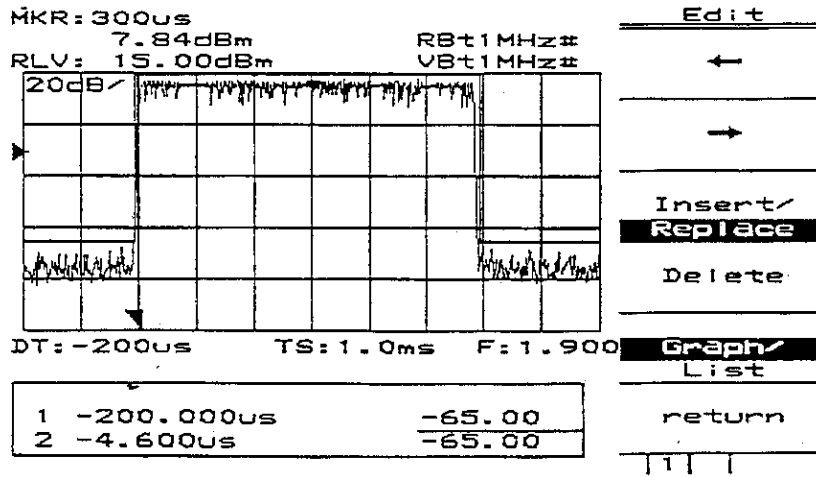

TEMPLATE Creation Screen (Graph)

No.	Time	Level ( dB )
1	-200.000us	-65.00
2	-4.600us	-65.00
3	-4.600us	-1.00
4	594.320us	-1.00
5	594.320us	-65.00
6	1.000000ms	-65.00
7		
8		
9		
10		
11		
12		

1	-200.000us	-65.00
2	-4.600us	-65.00

Edit  
 ←  
 →  
 Insert/  
**Replace**  
 Delete  
 Graph/  
**List**  
 return  
 | | |

TEMPLATE Creation Screen (List)



## 3) Template coordinates (PHS: RCR STD-28)

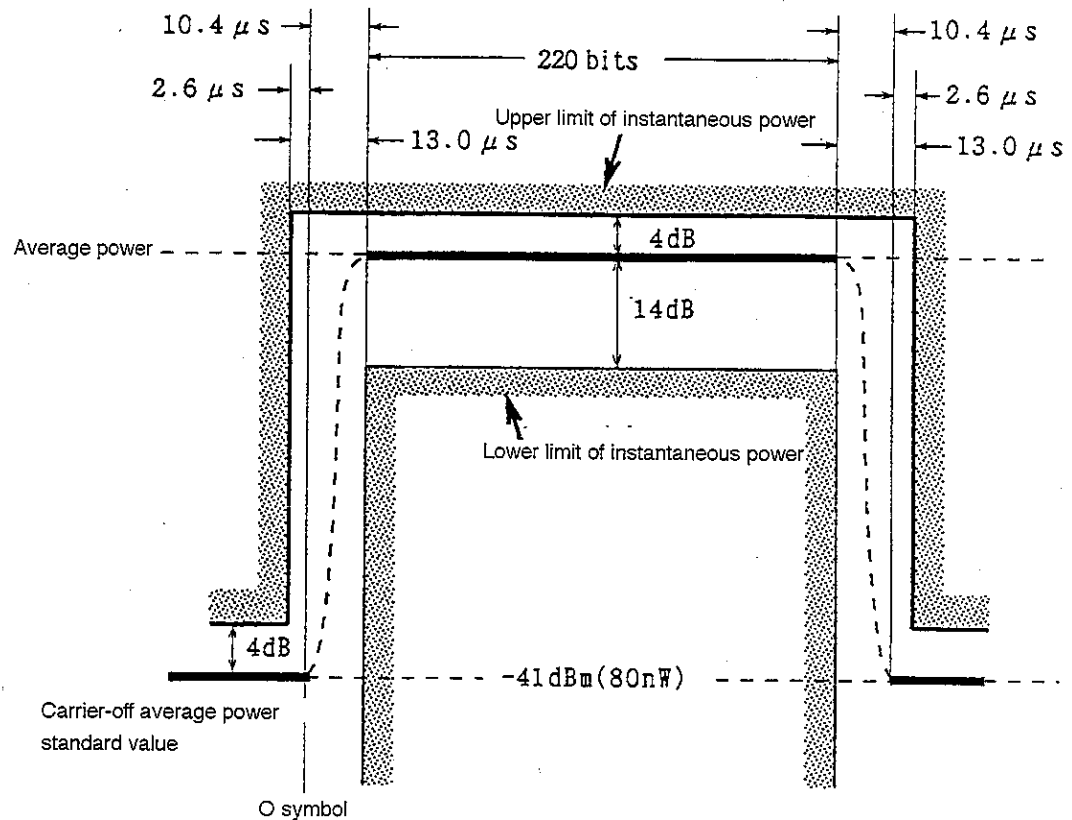

Coordinate reference line (Trigger position  $\rightarrow$  left end of screen: -200  $\mu$ s)

When average power in burst of input signal is 19 dBm and SPA REF LEVEL is 24 dBm

• Limit1 Upper coordinates

(1)	-200 $\mu$ s,	-65 dB
(2)	-4.6 $\mu$ s,	-65 dB
(3)	-4.6 $\mu$ s,	-1 dB
(4)	594.32 $\mu$ s,	-1 dB
(5)	594.32 $\mu$ s,	-65 dB
(6)	1 ms,	-65 dB

• Limit1 Lower coordinates

(1)	8.40 $\mu$ s,	-100 dB
(2)	8.40 $\mu$ s,	-19 dB
(3)	581.32 $\mu$ s,	-19 dB
(4)	581.32 $\mu$ s,	-100 dB

4) Template coordinates (PDC-RCR STD-27B)

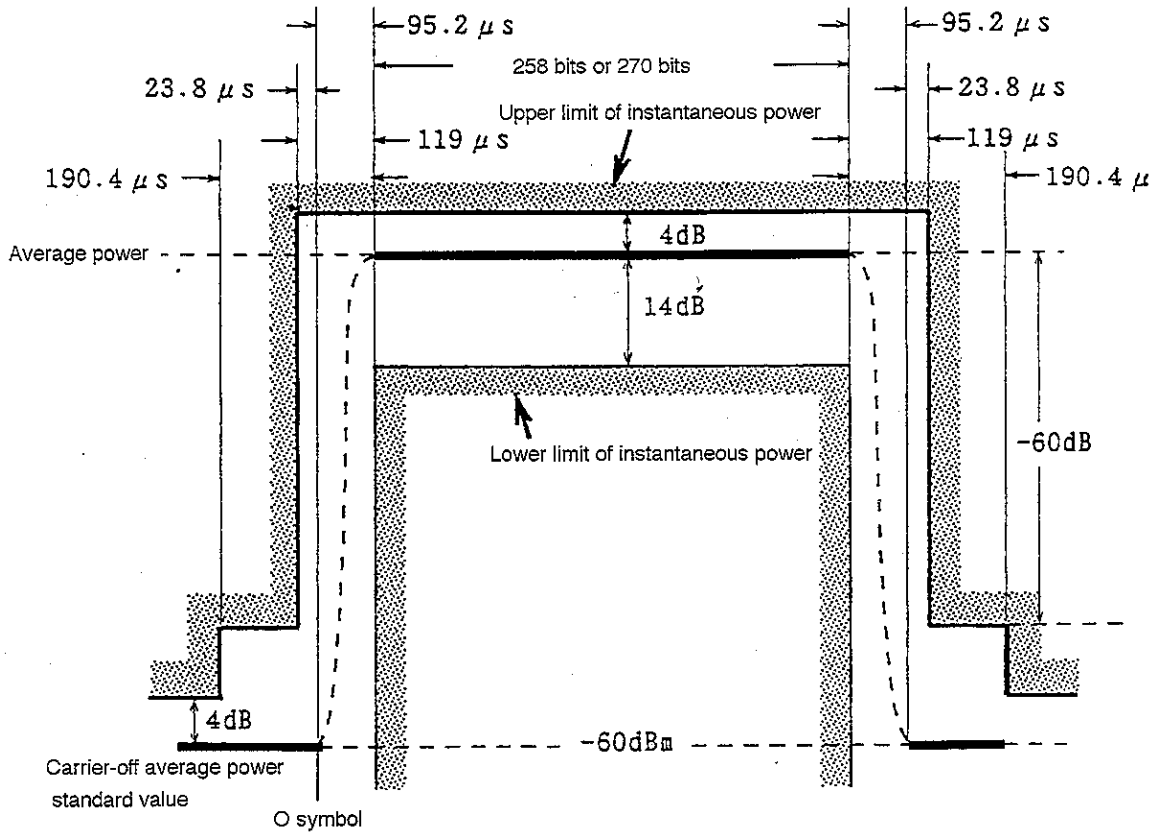

Coordinates standard line (Trigger position → screen left end: -1 ms)

When average power in burst of input signal is 10 dBm and SPA REF LEVEL is 15 dBm

• Limit1 Upper coordinates

(1)	-1.7 ms,	-71 dB
(2)	-114.21 μs,	-71 dB
(3)	-114.21 μs,	-65 dB
(4)	42.81 μs,	-65 dB
(5)	42.81 μs,	-1 dB
(6)	6.6238 ms,	-1 dB
(7)	6.6238 ms,	-65 dB
(8)	6.6952 ms,	-65 dB
(9)	6.6952 ms,	-71 dB
(10)	8.3 ms,	-71 dB

• Limit1 Lower coordinates

(1)	76.19 μs,	-100 dB
(2)	76.19 μs,	-19 dB
(3)	6.5048 ms,	-19 dB
(4)	6.5048 ms,	-100 dB

## 5) Template coordinates (GSM, DCS1800)

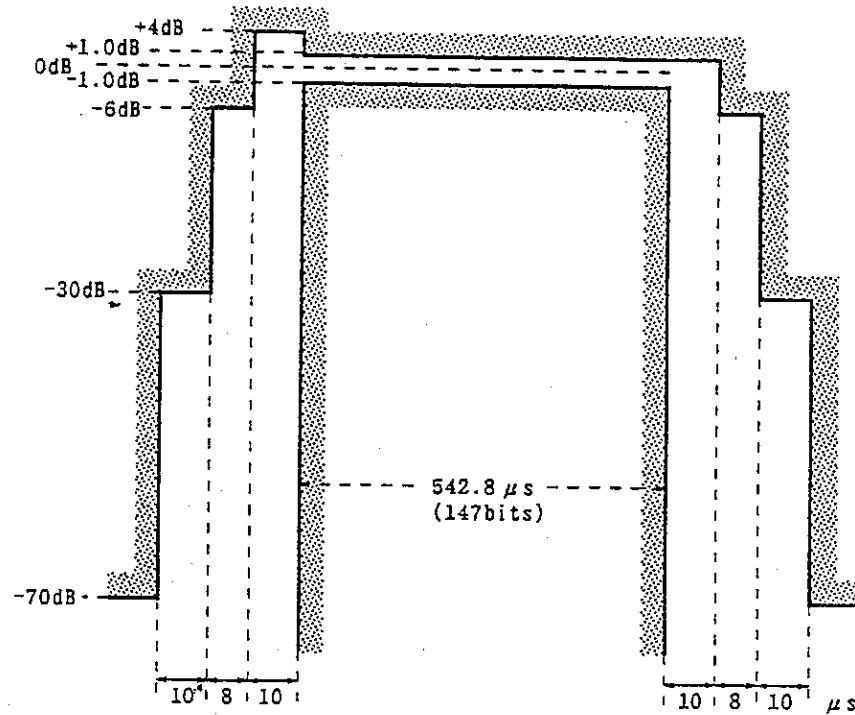

Coordinates standard line (Trigger position  $\rightarrow$  left end of screen:  $-75.0 \mu\text{s}$ )

- Limit 1 Upper coordinates

(1)	$-75.0 \mu\text{s}$ ,	$-75 \text{ dB}$
(2)	$-25.0 \mu\text{s}$ ,	$-75 \text{ dB}$
(3)	$-25.0 \mu\text{s}$ ,	$-35 \text{ dB}$
(4)	$-15.0 \mu\text{s}$ ,	$-35 \text{ dB}$
(5)	$-15.0 \mu\text{s}$ ,	$-11 \text{ dB}$
(6)	$-7.0 \mu\text{s}$ ,	$-11 \text{ dB}$
(7)	$-7.0 \mu\text{s}$ ,	$-1 \text{ dB}$
(8)	$3.0 \mu\text{s}$ ,	$-1 \text{ dB}$
(9)	$3.0 \mu\text{s}$ ,	$-4 \text{ dB}$
(10)	$555.8 \mu\text{s}$ ,	$-4 \text{ dB}$
(11)	$555.8 \mu\text{s}$ ,	$-11 \text{ dB}$
(12)	$563.8 \mu\text{s}$ ,	$-11 \text{ dB}$
(13)	$563.8 \mu\text{s}$ ,	$-35 \text{ dB}$
(14)	$573.8 \mu\text{s}$ ,	$-35 \text{ dB}$
(15)	$573.8 \mu\text{s}$ ,	$-75 \text{ dB}$
(16)	$625.0 \mu\text{s}$ ,	$-75 \text{ dB}$

- Limit 1 Lower coordinates

(1)	$3.0 \mu\text{s}$ ,	$-100 \text{ dB}$
(2)	$3.0 \mu\text{s}$ ,	$-6 \text{ dB}$
(3)	$545.8 \mu\text{s}$ ,	$-6 \text{ dB}$
(4)	$545.8 \mu\text{s}$ ,	$-100 \text{ dB}$

## MASK Creation in Frequency Domain Mode

### 1) Mask data write method

- Template scale number setting (Here it is 1.):  
Press [A, B] and F1: <<Trace A>> and press [Measure] until F3: <<Mask>> is displayed, then press F3: <<Mask>>, F5: <<Setup Mask Table>>, F1: <<Select Mask Table>>, F1: <<Mask-1>>, F6: <<return>>.
- Data write preparation: Select Relative with F2: <<Level>>.  
F3: <<Make Up Mask Table>>, [More], F2: <<Select Line>>, F1: <<Limit1 Upper>>, F6: <<return>>, [More] (Here, Limit1 Upper is specified.)
- Data write: Write the coordinates (frequency, level) of the template to be created in ascending order of time value.  
Write the data by alternately repeating time setting and level setting.  
\*Frequency setting (example: 800 MHz): [8], [0], [0], [MHz]  
\*Level setting (example: -60 dB): [+/-], [6], [0], [dB]
- Limit1 Lower write: Press [More], F2: <<Select Line>>, F2: <<Limit1 Lower>>, F6: <<return>>, [More], then write the mask data coordinates data.

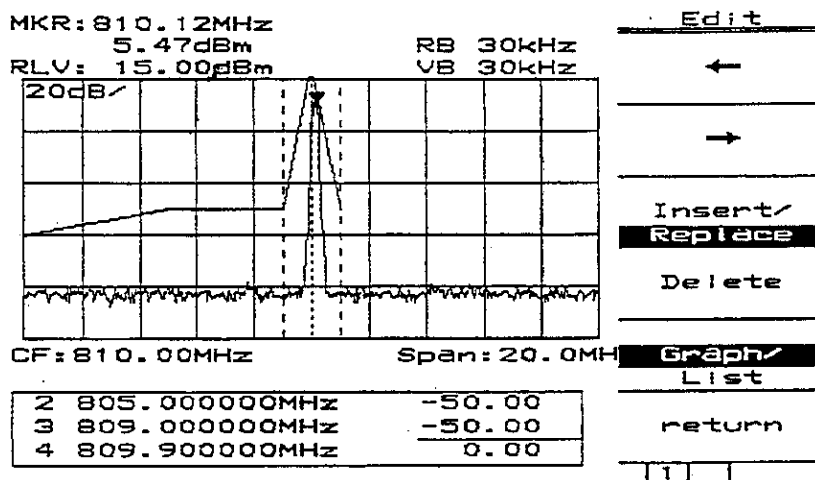

MASK Creation Screen (Graph)

No.	Frequency	Level ( dB )
1	800.000000MHz	-60.00
2	805.000000MHz	-50.00
<b>3</b>	<b>809.000000MHz</b>	<b>-50.00</b>
4	809.900000MHz	0.00
5	810.100000MHz	0.00
6	811.000000MHz	-50.00
7		
8		
9		
10		
11		
12		

2	805.000000MHz	-50.00
3	809.000000MHz	-50.00
4	809.900000MHz	0.00

Edit  
 ←  
 →  
 Insert/  
**Replace**  
 Delete  
 Graph/  
**List**  
 return  
 | | | |

MASK Creation Screen (List)



# SECTION 14

## EXTERNAL MIXER

This section describes operating the external mixer.

### TABLE OF CONTENTS

Function .....	14-4
Connecting the external mixer .....	14-5
Setting the band of the external mixer .....	14-6
Switching the external mixer on/off .....	14-6
Biasing the external mixer .....	14-6
Setting the conversion loss of the external mixer .....	14-7
Identifying the signal-Signal ID .....	14-8





# SECTION 14

## EXTERNAL MIXER FUNCTION

External mixer function is MS2667C/68C dedicated function.

The frequency range of MS2667C/68C extends up to 110 GHz by using optional external mixer.

2-port mixer can be used as the MS2667C/68C external mixer.

The recommended external waveguide mixer are shown below.

Part number	Frequency range	Waveguide frange
M42HW	18 to 26.5 GHz	MIL-F3922/68-001KM
M28HW	26.5 to 40 GHz	MIL-F3922/68-001AM
M22HW	33 to 50 GHz	MIL-F3922/67B-006
M19HW	40 to 60 GHz	MIL-F3922/67B-007
M15HW	50 to 75 GHz	MIL-F3922/67B-008
M12HW	60 to 90 GHz	MIL-F3922/68B-009
M10HW	75 to 110 GHz	MIL-F3922/68B-010

These mixers are made by Oleson Microwave Labs.

## Function

To operate the external mixer, perform the following key operations.

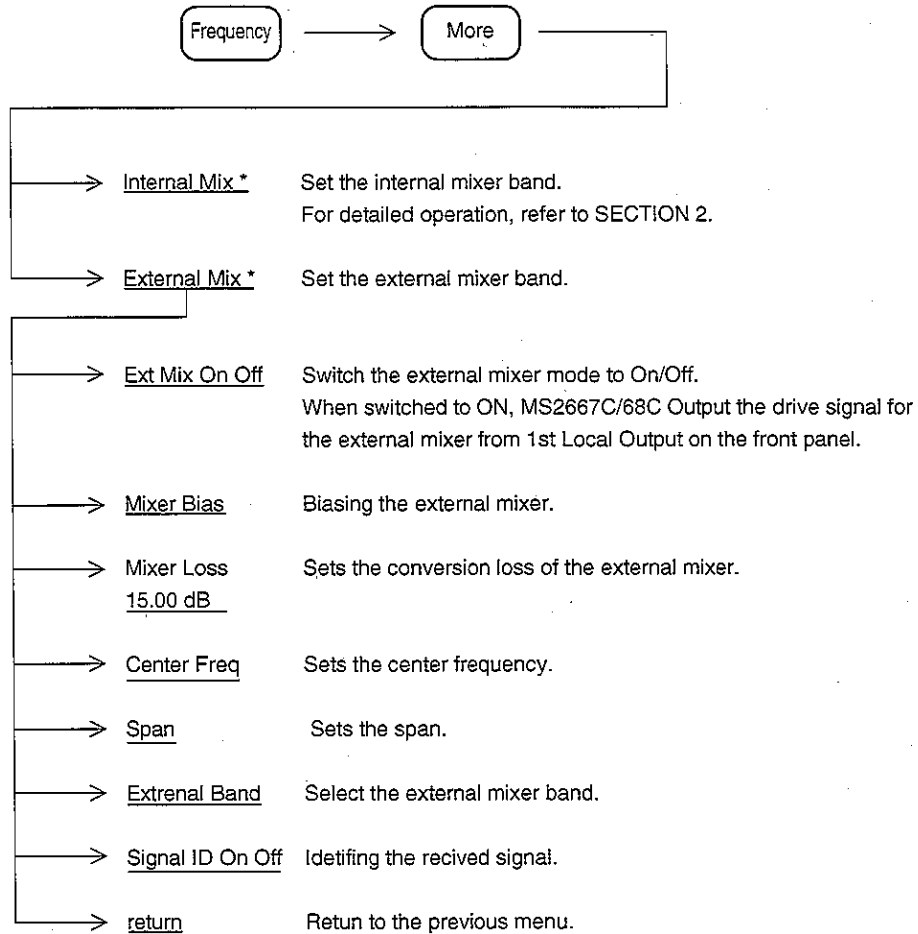

## Connecting the external mixer

The below figure illustrates how to connect the external mixer to the MS2667C/68C.

Step	Procedure
1	Fix the external mixer to the device under test.
2	Connect the optional coaxial cable J0322B to the 1st Local Output on the front panel.
3	Connect the coaxial cable to the IF/LO interface on the external mixer.

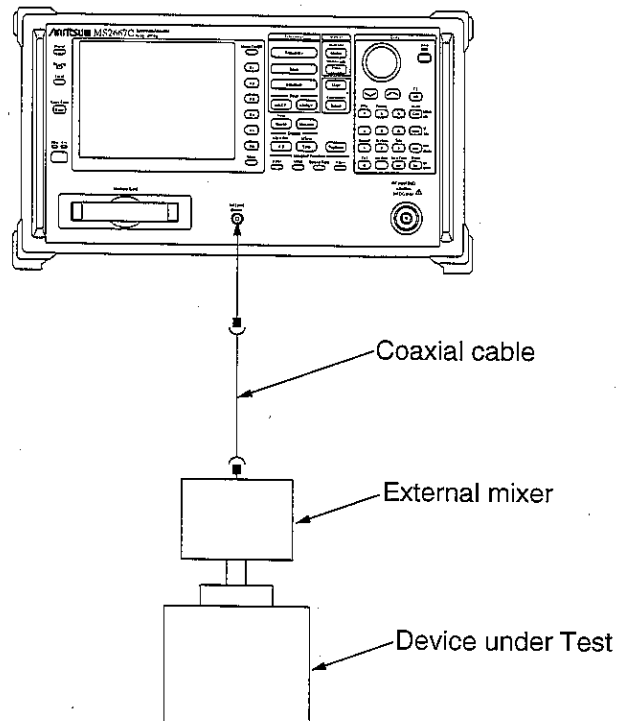

*Note:*

- \*1 Use the low insertion loss cable among Local frequency range(4 to 7GHz) and IF frequency (689.31MHz) that is connected the external mixer.
- \*2 Tighten the SMA connector by the regulation torque.
- \*3 Don't lost the terminator for the 1st Local Output.

## Setting the band of the external mixer

To set the band, perform the following key operation.

External Mix\* → **More** → External Band K

Select the band(K, A, Q, U, V, E, W) by the rotary knob and step key.

The below table shows band, frequency range and harmonic order of the external mixer.

Band	Frequency range	harmonic order (N)
K	18.0 to 26.5 GHz	4+/-
A	26.5 to 40.0 GHz	6+/-
Q	33.0 to 50.0 GHz	8+/-
U	40.0 to 60.0 GHz	9+/-
V	50.0 to 75.0 GHz	11+/-
E	60.0 to 90.0 GHz	13+/-
W	75.0 to 110.0 GHz	16+/-

The below equation shows the side band phase noise on the selected band.

$$\text{Sideband phase noise} = -95\text{dBc/Hz} + 20 \text{ Log N}$$

## Switching the external mixer On/Off

To switch to On, perform the following key operation.

External Mix\* → **Ext Mix On Off**

When Ext Mix On is selected, MS2667C/68C Output the driving signal for the external mixer from the 1st Local Output on front panel.

## Biasing the external mixer

To bias the external mixer, perform the following key operation.

External Mix\* → **Mixer Bias 10**

Adjust the optimum biasing level so that level of the received signal on the screen become maximum by rotary knob ten key and step key.

Biasing range is -0 to +20mA (0.1mA resolution).

*Note:*

\*1 The frequency response of the external mixer depends on bias level. When changed the frequency in the same band, be sure to adjust the optimum biasing level.

## Setting the conversion loss of the external mixer

To set the conversion loss of the external mixer, perform the following operations.

External Mix\* → Mixer Loss 15 dB

Set the conversion loss of the external mixer to measure correct level by rotary knob, ten key and step key.

The range of the conversion loss is 0.00dB to 99.99dB(0.01dB resolution).

*Note:*

- \*1 *To set the correct value, calibrate by power meter.*
- \*2 *The Reference level setting range changes according to the mixer conversion loss setting, as shown below:*

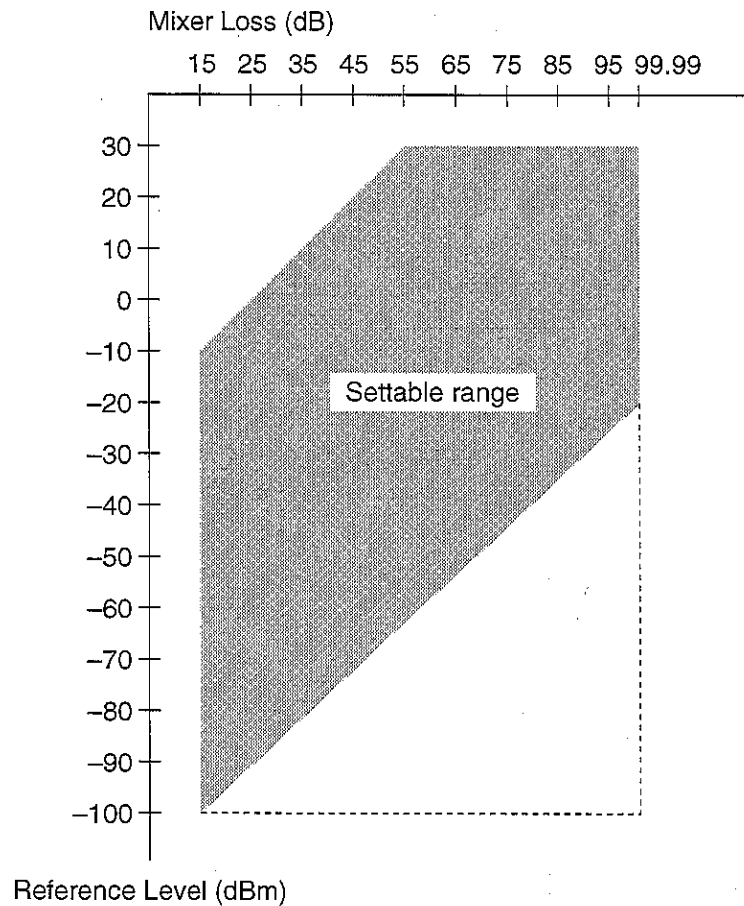

## Identifying the signal-Signal ID

Shall identify the signal on the screen in case of non preselecting external mixer.  
Because IF output of external mixer contains many mixer product by following equation.

IF frequency = RF frequency  $\pm$  LO frequency  $\times$  N  
 IF frequency of MS2667C/68C is equal to 689.31MHz.  
 N is harmonic order at mixer.

The signal inversed polarity( $\pm$ ) to Local signal is called "image response".  
 Also the signal multiplied local signal by incorrect harmonic order(N) is called "multiple respose"

Signal ID function switch to polarity( $\pm$ ) to local signal alternately at each sweep.  
 Consequently, the correct signal on the screen does not change the position(frequency) alternately at each sweep.  
 Also false signal on the screen shift alternately the position(frequency) by more amout of IF frequency  $\times 2$  at each sweep.

To switch to On sigana ID function, perform following key operations.

External Mix\*  $\rightarrow$  More  $\rightarrow$  Signal ID On Off

*Note:*

*\*1 When recived signal that is not specified, be sure to execute signal ID. Also after executed identifying the signal, shall swich to Off signal ID because the signal that is recived by inverse polarity change the level by the frequency response of external mixer.*

# APPENDIX A

## SOFT-KEY MENU

In this section, soft-key menu functions and its hierarchical system are described using a tree.

### TABLE OF CONTENTS

Soft-key Menu List .....	A-4
Menu Tree .....	A-8





# APPENDIX A SOFT-KEY MENU

In this section, soft-key menu functions and its hierarchical system are described using a tree. Matters to be noted about the tree are shown below.

- (1) Panel Key indicates a hard key on the front panel.
- (2) Top menus are the menus at the top level which are displayed on the screen when the panel key is pressed. Lower menus indicates other menus below the top menus.
- (3) When a soft key with an appended asterisk (\*) is pressed in these menus, the menu moves to the lower menu indicated by the arrow symbol (->). However, if any not-supported-function soft key in an Option is pressed, an error message is displayed.
- (4) When the Return key is pressed at a lower menu, the next-higher menu is returned.
- (5) Menus with more than six items are split into several pages.
- (6) The menu page construction and currently-displayed page are indicated in the lower part of the menu. To move to the next page, press the [More] key.
- (7) Panel keys and soft keys prefixed by a sharp symbol (#) at the left of the menu frame, give an outline explanation of the function.

## Soft-key Menu List

Menu		MS2665C Menu Tree (page/25)	MS2667C/68C Menu Tree (page/25)
<b>A</b>	A/B,A/BG	15	15
	A/Time	16	16
	ACP Setup1	8	8
	ACP Setup2	8	8
	ACP Setup3	8	8
	Ajd ch pwr	8	8
	Amplitude	2	2
	Attenuator	2, 3	2, 3
	Avg Count	14	14
<b>B</b>	Band	1	1
	Brightness	19	19
	Burst Pwr	11	11
<b>C</b>	C/N Meas	7	7
	Channel Power Measure	7	7
	Cal	20	20
	Ch Power	7	7
	Change Clr	19	19
	Check File	23	23
	Copy Cont	18	18
	Copy from	19	19
	Correction	2	2
	Count Setup	7	7
<b>D</b>	Def files	24	24
	Def Menus	24	24
	Define	24	24
	Define Clr	19	19
	Detection	14, 16	14, 16
	Dip	5	5
	Directory	22	22
	Disp Line	2, 4	2, 4
	Display	19	19
<b>E</b>	Edit Menu	24	24
	Ext Mix	-	2
	Expand	16	16

Menu		MS2665C Menu Tree (page/25)	MS2667C/68C Menu Tree (page/25)	
<b>F</b>	File Ope			
	FM monitor	16	16	
	Format	22	22	
	Freq Count	7	7	
	Freq Offset	-	1	
	Frequency	1	1	
<b>G</b>	Gate	17	17	
	Gate Setup	17	17	
<b>H</b>	Hold Count	14	14	
<b>I</b>	Impedance	2	2	
	Initialize	24	24	
	Interface	21	21	
	Int Mix	-	2	
	Item	12, 18	12, 18	
<b>L</b>	LCD Brightness	19	19	
	Lib Exec	23	23	
	Lib File	23	23	
	Lib Memory	23	23	
	Lib Prgm	24	24	
	Lib Remove	23	23	
	Lin Scale	2	2	
	Line	9, 10	9, 10	
	Load/Save	9, 10	9, 10	
	Location	18	18	
	Log Scale	2	2	
	Lvl Offset	2	2	
	<b>M</b>	Manual Set	4	4
Marker		4	4	
Marker →		4, 5	4, 5	
Mask Meas		9	9	
Measure		7, 10	7, 10	
Media		2, 9, 10, 22, 24	2, 9, 10, 22, 24	
Mem Card		2, 9, 10, 22	2, 9, 10, 22	
Mkr Func		4	4	
Mkr List		4	4	
Move Mask		9	9	
Move Temp		10	10	
Multi Marker		4	4	
<b>N</b>		Noise Meas	7	7
<b>O</b>		OBW Setup	8	8
	Occ BW	8	8	

APPENDIX A SOFT-KEY MENU

Menu		MS2665C Menu Tree (page/25)	MS2667C/68C Menu Tree (page/25)
<b>P</b>	Paper Size	18	18
	Peak	5	5
	Plotter	18	18
	Pon State	19	19
	Preset	25	25
	Preslctr	20	20
	Printer	18	18
	PTA	22	22
	PTA Lib	23	23
<b>R</b>	RBW	3	3
	Recall	12	12
	Recl Media	12	12
	Ref Line	14	14
	Ref Step	2	2
	RS232C	21	21
<b>S</b>	Save	13	13
	Save Media	13, 18	13, 18
	Scroll Step	1	1
	Select	2, 9, 10	2, 9, 10
	Set Date	19	19
	Set Time	19	19
	Setup	2	2
	Setup Mask	9	9
	Setup Temp	10	10
	Source	16, 17	16, 17
	Sound	19	19
	Span	1	1
	Storage	14, 16	14, 16
	Sweep Time	3	3
	Sweep Cntl	15, 16	15, 16
System	19	19	
<b>T</b>	Temp Meas	10	10
	Threshold	5	5
	Title	21	21
	Trace A, B	14	14
	Trace Calc	14	14
	Trace Move	14	14
	Trace Time	16, 17	16, 17
	Trnsformer	2	2
	Trig Ext	17	17
	Trig Video	17	17
	Trigger	17	17

Menu		MS2665C Menu Tree (page/25)	MS2667C/68C Menu Tree (page/25)
<b>U</b>	Units	2	2
	User1	6	6
	User2	6	6
	User3	6	6
<b>V</b>	VBW	3	3
<b>W</b>	Wide IF	17	17
<b>Z</b>	Zone Width	4	4

# Menu Tree

## MS2665C Menu Tree (1/25)

Panel Key | Top menu | Lower menus

Frequency

Frequency
Center Freq
Start Freq
Stop Freq
Peak ->CF
#1 Auto Tune
#2 CF Step Size
1

- Set items related to frequency, including the center frequency, start/stop frequency, peak->CF, auto synchronization, frequency scroll step size and scroll step size, etc.

- #1 Detects peak point in pre-specified (in BG range) span and automatically tunes the peak signal to the specified span.
- #2 Sets frequency step size for changing center frequency.

Frequency
Band *
Scroll->
<-Scroll
Scroll Step Size *
2

ScrollStep
1div
2div
5div
10div
return

Band
Auto Band
Manual Band 0
Manual Band 1-
Manual Band 1+
return
1

Band
Auto Band
Manual Band 2+
Manual Band 3+
return
2

Span

Span
Span
Full Span
Zero Span
Scroll->
<-Scroll
Band *

- Set frequency span items, including frequency span, full span, zero span, frequency span scroll, etc.

MS2665C Menu Tree (2/25)

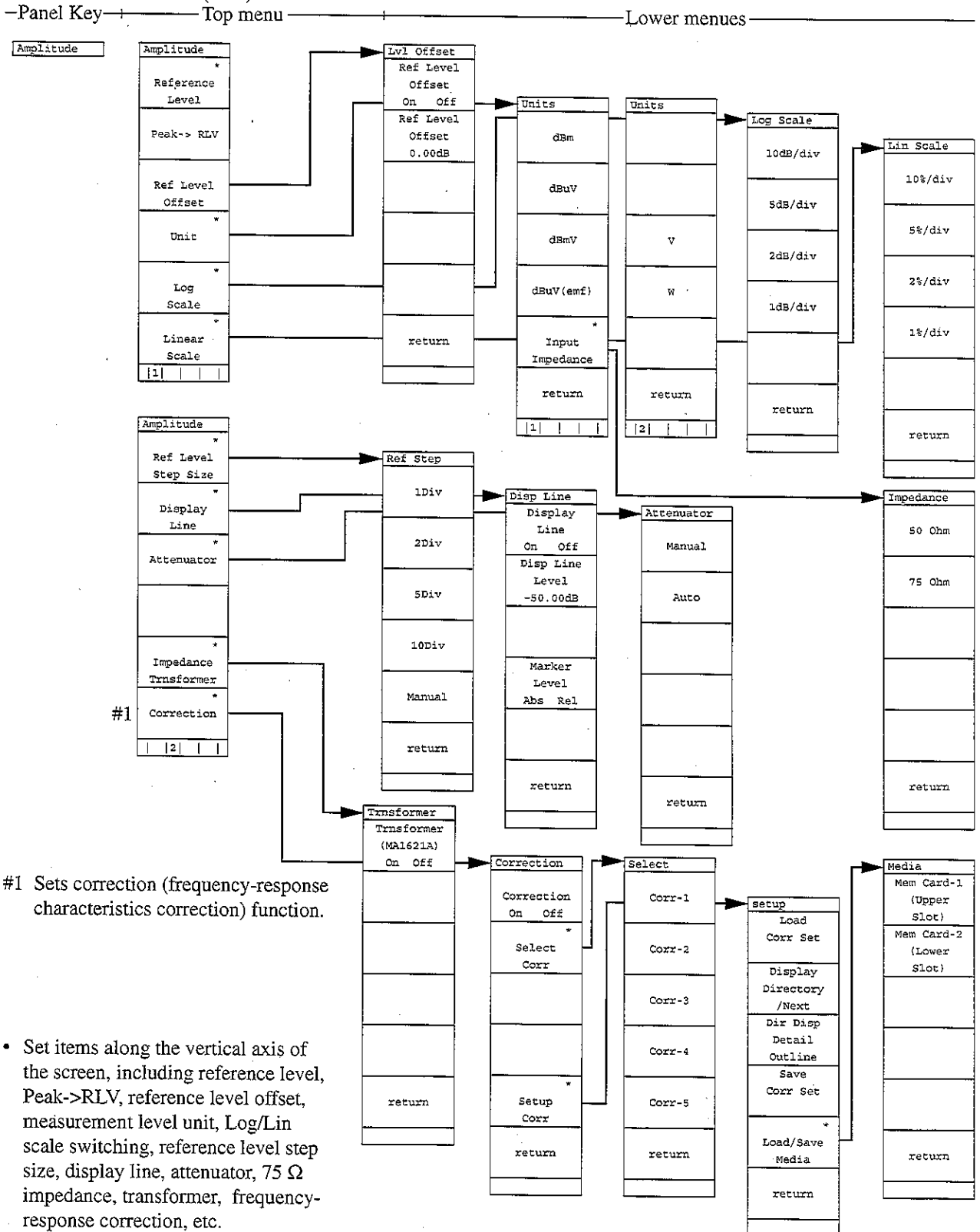

APPENDIX A SOFT-KEY MENU

MS2665C Menu Tree (3/25)

Panel Key | Top menu | Lower menus

RBW	RBW
	Manual
	Auto
	RB/Span Ratio On Off
	RB/Span Ratio 0.01
	RB, VB, SWT Auto
#1	All Auto

- Set the manual/auto of resolution bandwidth, and auto (RBW, VBW and SWP only) or all auto.
- Set Ratio of RBW to Span when RBW is Auto and Ratio Mode is "on".

#1 Sets RBW, VBW, Sweep Time, Atten all to Auto.

VBW

VBW
Manual
Auto
Filter Off
VB/RB Ratio 1.0
RB, VB, SWT Auto
All Auto

- Set the manual/auto of video bandwidth, and auto (RBW, VBW and SWP only) or all auto.

#2 Sets ratio of VBW to RBW when VBW is Auto.

Sweep Time

Sweep Time
Manual
Auto
RB, VB, SWT All Auto
All Auto

#2

- Set the manual/auto of sweep time, and auto (RBW, VBW and SWP only) or all auto.

Atten

Attenuator
Manual
Auto
All Auto



MS2665C Menu Tree (4/25)

-Panel Key-----Top menu-----Lower menus-----

Marker

Marker
Normal Marker
Delta Marker
Marker Off
Zone Width
Marker ->
1

- Set the selection of normal/delta/no marker, zone marker width, marker->, marker search mode, display line, marker tracking On/Off, zone sweep On/Off, etc.

#1

Mkr Func
Marker Search
Peak Dip
Display Line
Marker Tracking
On Off
Zone Sweep
On Off
2

- #1 Selects whether to search for maximum (Peak) or minimum (Dip) value in zone marker.
- #2 Toggles zone sweep On/Off. Usually, the zone sweep is Off. At On, the sweep time is reduced by sweeping only the zone specified by the zone marker.

#2

Zone Width
Spot
1Div
2Div
5Div
10Div
return

Marker ->
Mkr-> CF
Mkr->RLV
Mkr -> CF
Step Size
Delta Mkr -> Span
Zone -> Span
return

Disp Line
Display Line
On Off
Disp Line Level
-50.00dBm
Marker Level
Abs Rel
return

Multi Marker

Multi Mkr
Multi Marker
On Off
Highest 10
Marker List
Manual Set

#3

#4

#5

Mkr List
Marker List
On Off
Freq/Time
Abs Rel
Level
Abs Rel
return

Manual Set
Change Active Marker
Select Marker
4
On with Auto Select
Off with Auto Select
Clear All
return

- #3 Allocates up to 10 multi-markers sequentially from the peak level of the signal displayed on screen.
- #4 Allocates multi-markers to the harmonic signals of frequency indicated by current marker.
- #5 Function allowing user to select only multi-markers necessary for measurement.
- #6 Select "absolute value" or "relative value (display line)" to display marker level.

- Set multi-marker On/Off, 10 multi-marker, harmonic multi-marker, listing of multi-marker values, selection of necessary markers, etc.

MS2665C Menu Tree (5/25)

Panel Key | Top menu | Lower menus

Peak Search

Peak
Peak Search
Next Peak
Next Right Peak
Next Left Peak
Normal Marker
Delta Marker
[1]

- Set maximum level search, next peak, next right peak, next left peak, Marker->, minimum level search, next minimum level, search level resolution, threshold level On/Off, etc.

#1

Dip
Dip Search
Next Dip
Resolution
1.23 dB
Threshold
Marker ->
[2]

#2

Threshold
Threshold On Off
Search Above Below
Threshold Level
-50.00 dBm
return

#1 Searches for minimum (Dip) level.

#2 Sets peak-search level resolution.

Marker Peak Search

Marker ->
Mkr-> CF
Mkr->RLV
Mkr -> CF
Step Size
Delta Mkr -> Span
Zone -> Span

Marker ->
Mkr-> CF
Mkr->RLV
Mkr -> CF
Step Size
Delta Mkr -> Span
Zone -> Span
return

- Set marker value -> center frequency, marker value -> reference level, marker value -> CF step size, delta marker-> span, zone marker -> span, etc.

MS2665C Menu Tree (6/25)

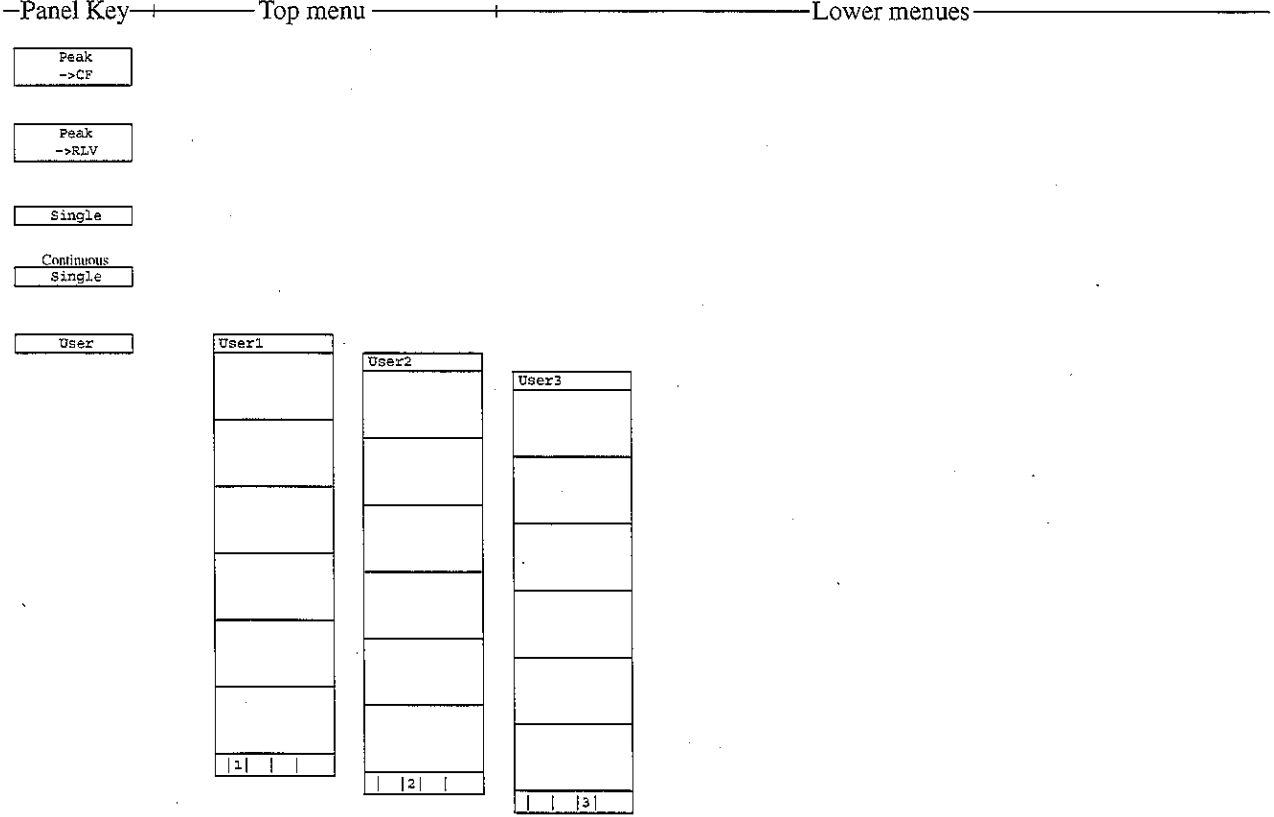

- The soft-key menu defined by the user is displayed.  
(See "User Define".)

MS2665C Menu Tree (7/25)

Panel Key | Top menu | Lower menus

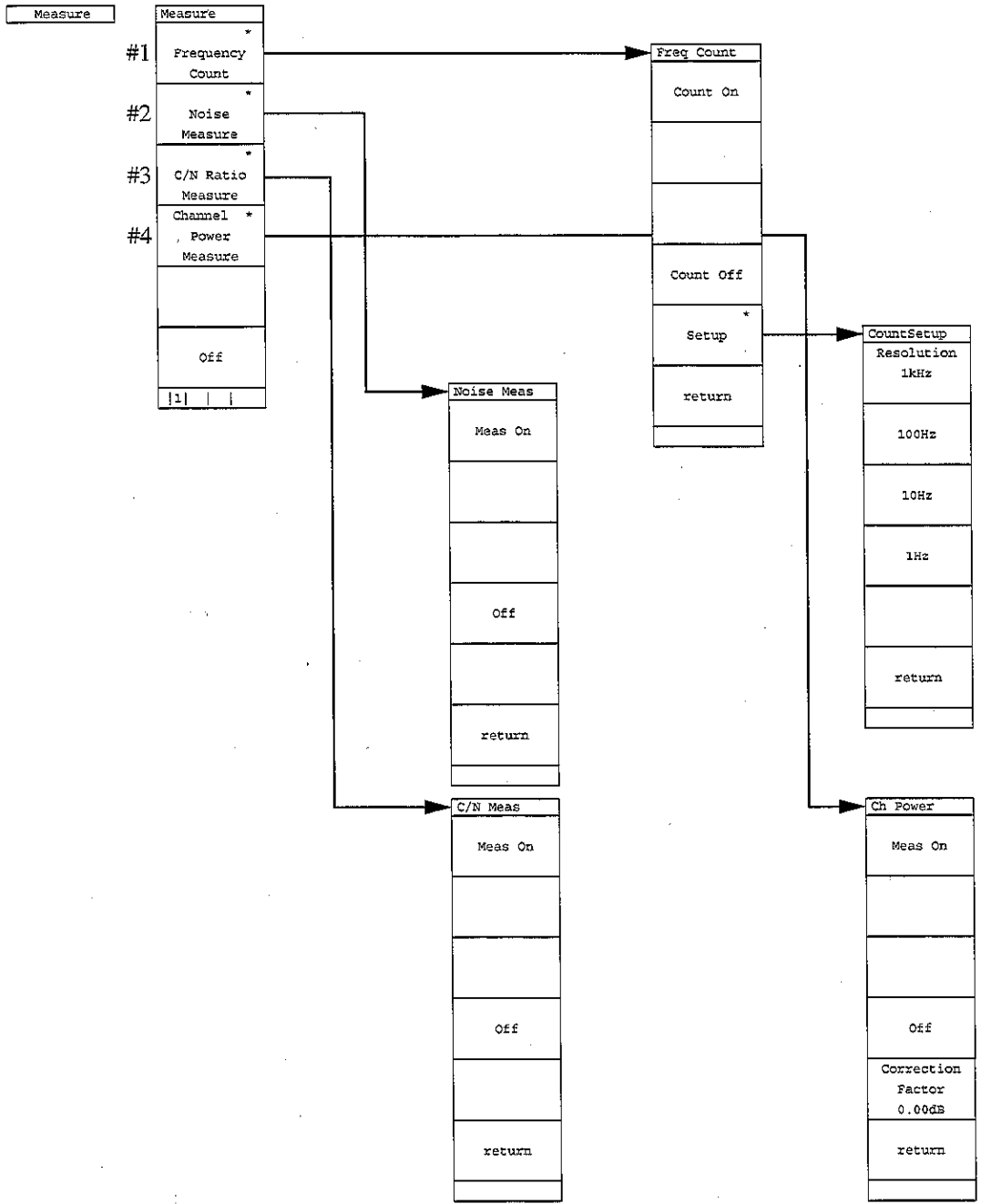

- Perform measurement according to various applications:
  - #1 Frequency Count: Measure marker frequency with a high resolution. Select resolution from 1 kHz, 100 Hz, 10 Hz and 1 Hz.
  - #2 Noise Measure: Measure the noise power within zone marker.
  - #3 C/N Ratio Measure: Measure the ratio of carrier signal and noise power. Reference marker of the delta marker shall be set to the carrier, and marker's zone width specifies the power measured.
  - #4 Channel Power Measure: Power within the band indicated by zone marker is measured. It is possible to set an arbitrary calibration value.

MS2665C Menu Tree (8/25)  
 -Panel Key- Top menu Lower menus

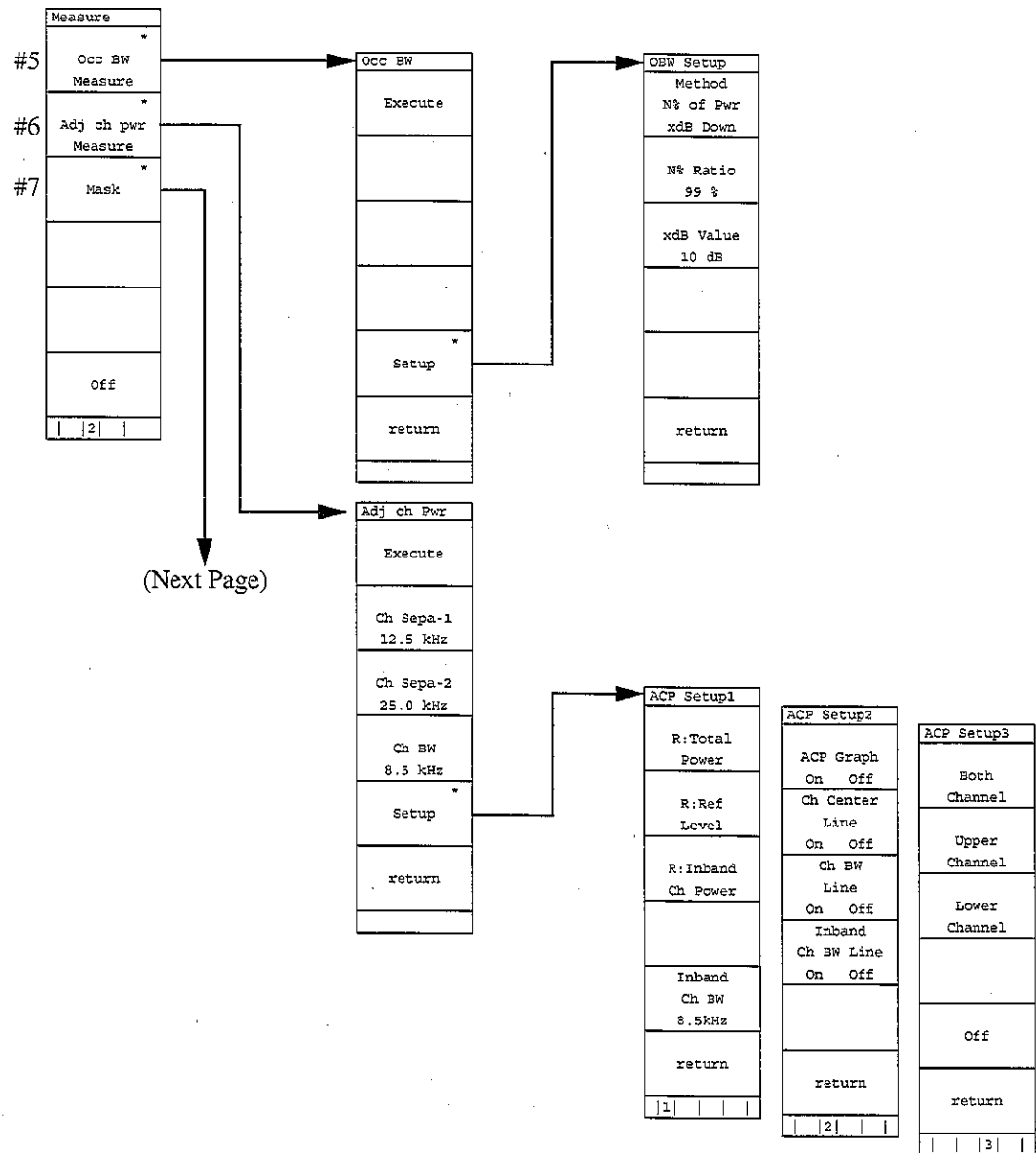

- #5 Occ BW Measure: Measure the occupied bandwidth.  
Select the X dB DOWN or N % of POWER mode.
- #6 Adj ch pwr Measure: Measure leak power from adjacent channels.  
Select Channel Separate, Channel Bandwidth and Measurement Mode (Method), On/Off of ACP Graph, On/Off of Channel Center Line and On/Off of Channel BW Line, Upper Channel, Lower Channel or Both Channel, etc.
- #7 Mask: Set Standard Line of the frequency domain and judge Good/NG in relation to the standard line. Select Mask Table, Mask Movement, Measurement Mode, Mask Table Preparation, Load/Save of Mask Table, etc.

MS2665C Menu Tree (9/25)

Panel Key | Top menu | Lower menus

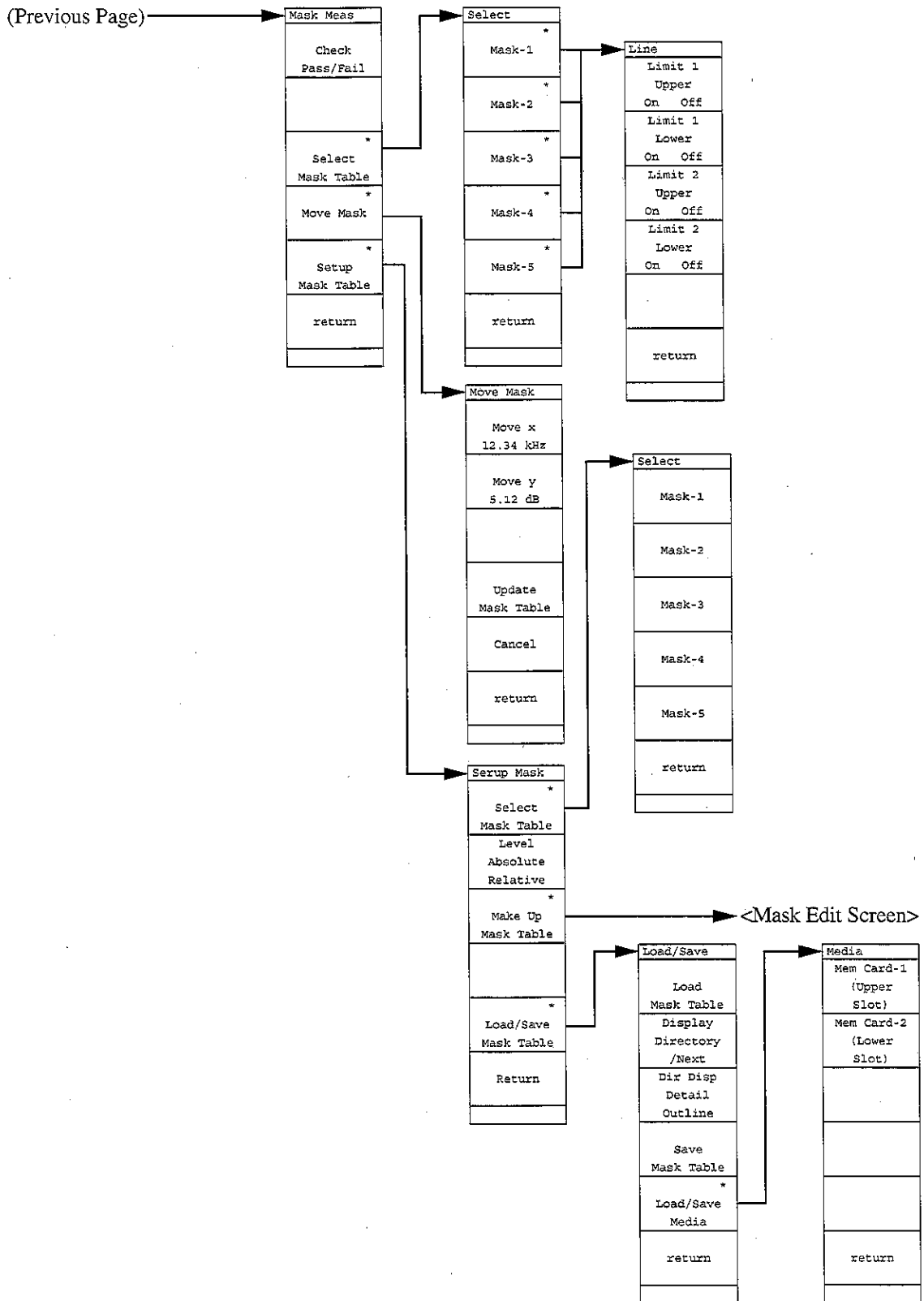

MS2665C Menu Tree (10/25)

-Panel Key- Top menu Lower menus

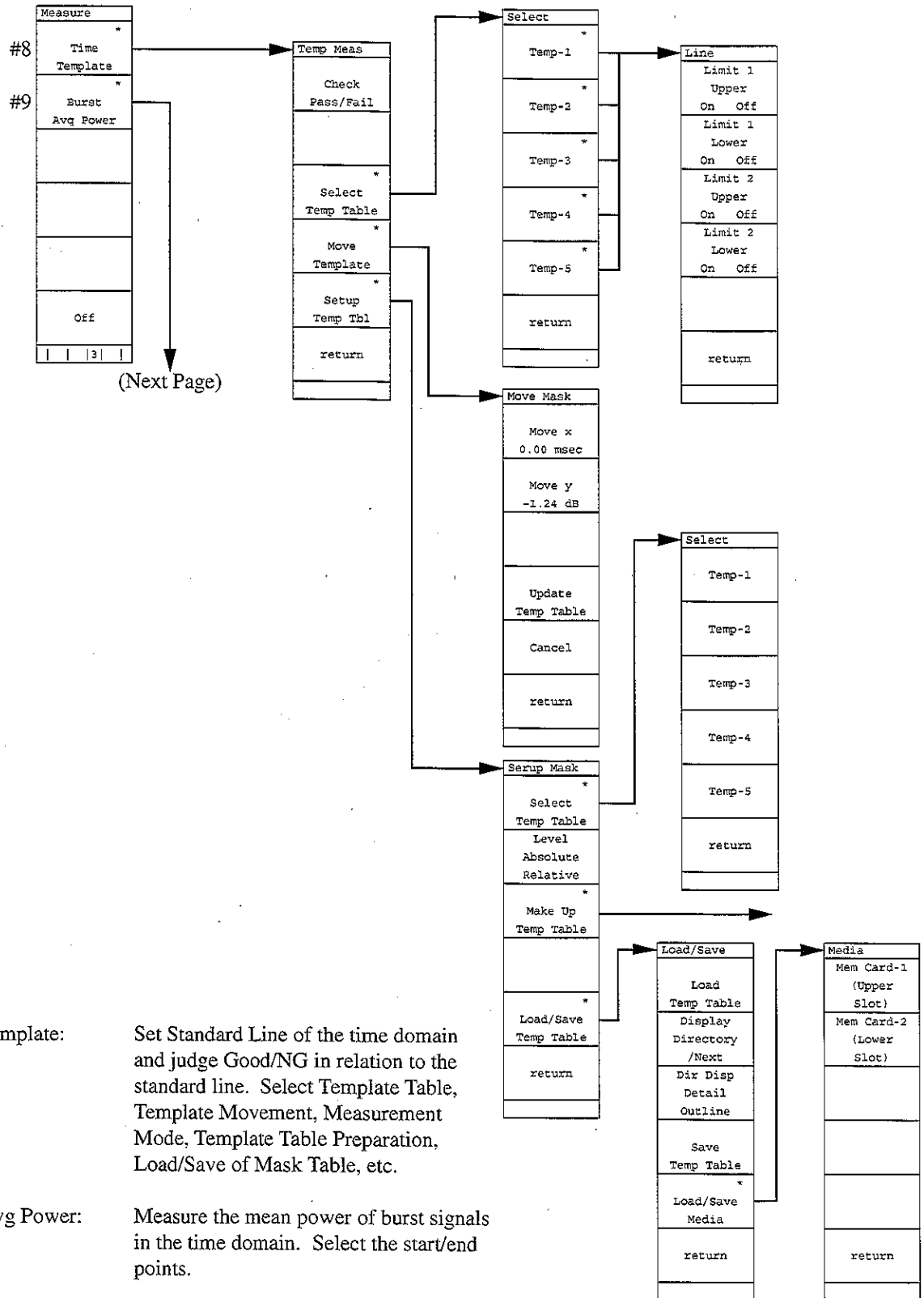

(Next Page)

#8 Time Template: Set Standard Line of the time domain and judge Good/NG in relation to the standard line. Select Template Table, Template Movement, Measurement Mode, Template Table Preparation, Load/Save of Mask Table, etc.

#9 Burst Avg Power: Measure the mean power of burst signals in the time domain. Select the start/end points.

APPENDIX A SOFT-KEY MENU

MS2665C Menu Tree (11/25)

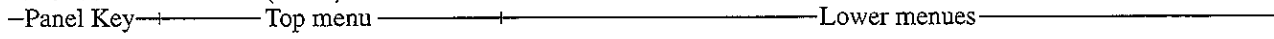

(Previous Page) →

Burst Pwr
Execute
Start Point 100
Stop Point 100
return



MS2665C Menu Tree (12/25)

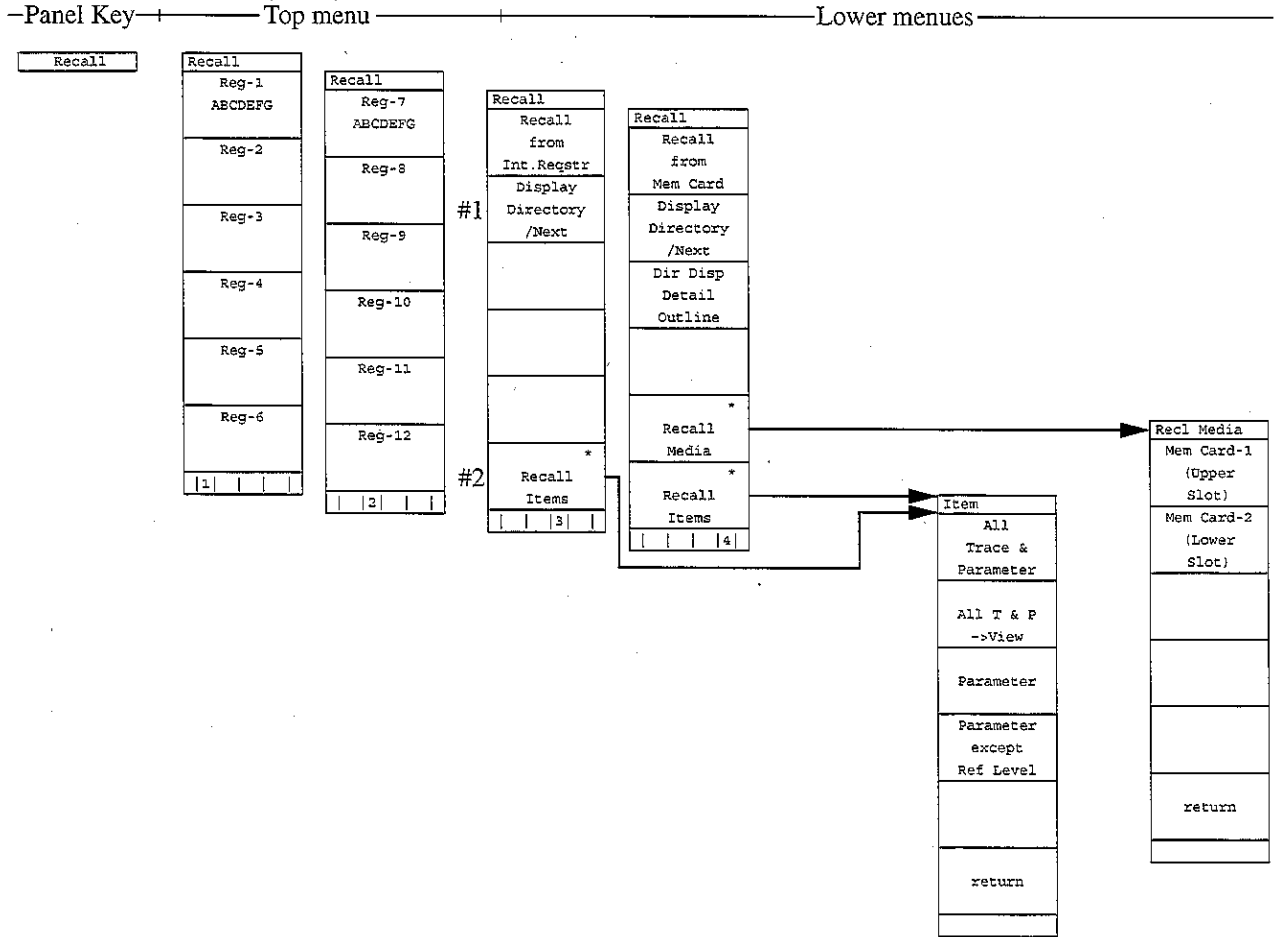

- Read out trace waveform/parameters from the internal memory or memory card. Select recall addresses and media/items, and display file directories.

#1 Displays list of internal-memory directories.

#2 Specifies items to be recalled (trace waveform, parameter, etc.).

APPENDIX A SOFT-KEY MENU

MS2665C Menu Tree (13/25)

Panel Key — Top menu — Lower menus

Save
Recall

Save
Save to Int. Registr
Display Directory /Next
1

- Save trace waveform/parameters to the internal memory or memory card. Select saved media, and display file directories.

Save
Save to Mem Card
Display Directory /Next
Dir Disp Detail Outline
Save Media
2

Save Media
Mem Card-1 (Upper Slot)
Mem Card-2 (Lower Slot)
return

Save
Save BMP file to Memcard
Display Directory /Next
Dir Disp Detail Outline
Save Media
3

MS2665C Menu Tree (14/25)

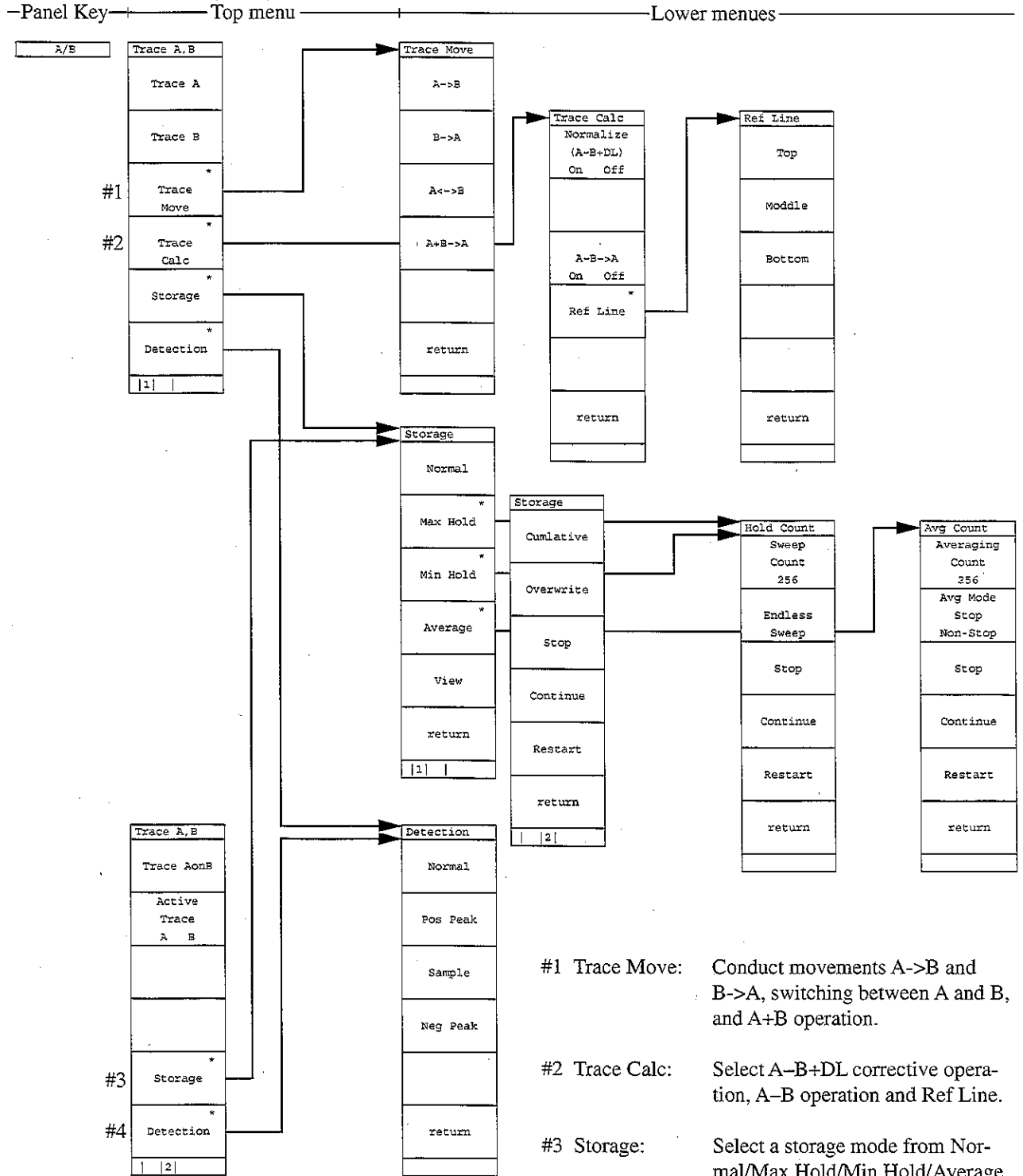

- Select Trace A/B, movement between Trace A/B, sum/difference operation between Trace A/B and Ref Line, and designate the storage and detection modes and Active Trace.

- #1 Trace Move: Conduct movements A->B and B->A, switching between A and B, and A+B operation.
- #2 Trace Calc: Select A-B+DL corrective operation, A-B operation and Ref Line.
- #3 Storage: Select a storage mode from Normal/Max Hold/Min Hold/Average. Set Sweep Count, Rewrite/Overwrite, Stop Continue, Restart, etc.
- #4 Detection: Select a detection mode from Normal/Pos Peak/Neg Peak/Sample.

MS2665C Menu Tree (15/25)

Panel Key ————— Top menu ————— Lower menus

A/B, A/BG A, B	A/B, A/BG
#1	A/B (A<B)
	A/B (A>B)
	A/BG (A<BG)
	A/B (A>BG)
	Sweep Control

- Simultaneously display two waveforms, namely Trace A and Trace B or Trace A and Trace BG (peripheral spectrum containing Trace A). The large display is Main Trace and the small one is Sub Trace; select which to display as Main Trace (or Sub Trace). Sweep Control: Set Stop/Continuous/Restart for sweep and Stop/Write for Sub Trace.

#1 Displays two traces A and B simultaneously at top and bottom of screen. The trace-B display is the larger at this time.

Sweep Cntl
Sub Trace Write
Sub Trace View
Stop
Continue
Restart
return

MS2665C Menu Tree (16/25)

Panel Key → Top menu → Lower menus

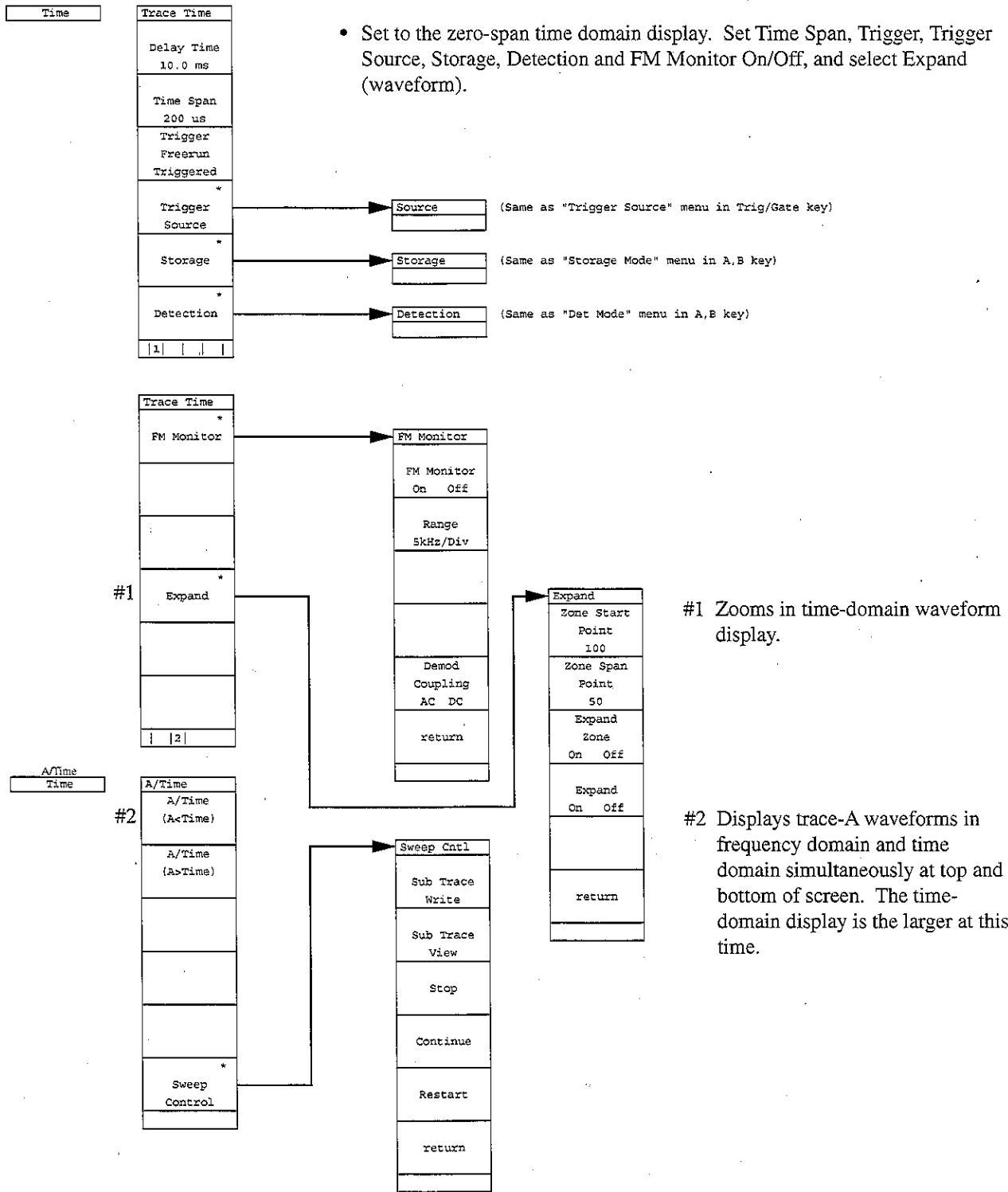

MS2665C Menu Tree (17/25)

-Panel Key- Top menu Lower menus

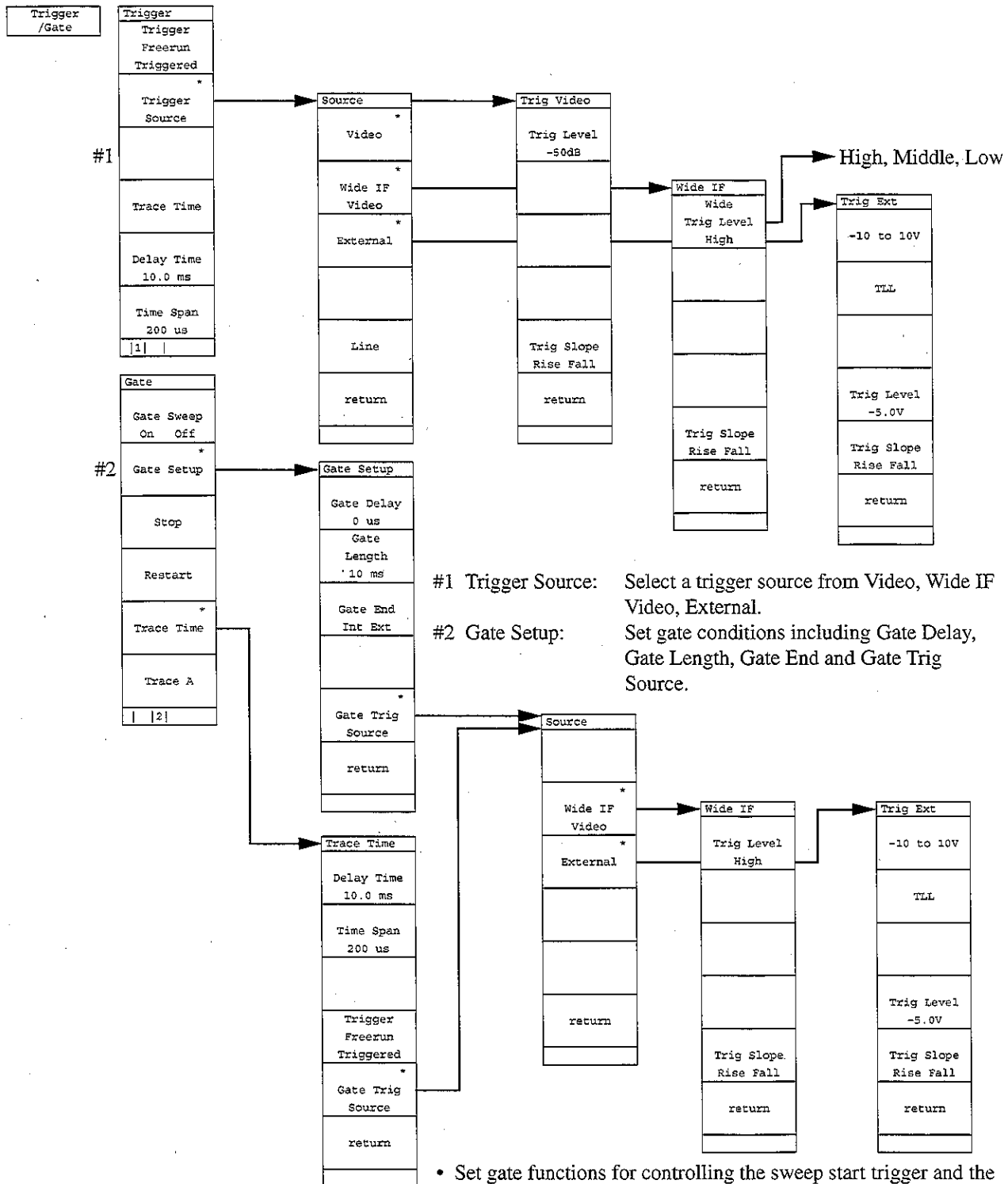

#1 Trigger Source: Select a trigger source from Video, Wide IF Video, External.  
 #2 Gate Setup: Set gate conditions including Gate Delay, Gate Length, Gate End and Gate Trig Source.

- Set gate functions for controlling the sweep start trigger and the writing of waveform data. Set the trigger mode, trigger source, trace time, delay time and time span. Select On/Off, Stop and Restart of Gate Sweep.

MS2665C Menu Tree (18/25)

Panel Key — Top menu — Lower menus

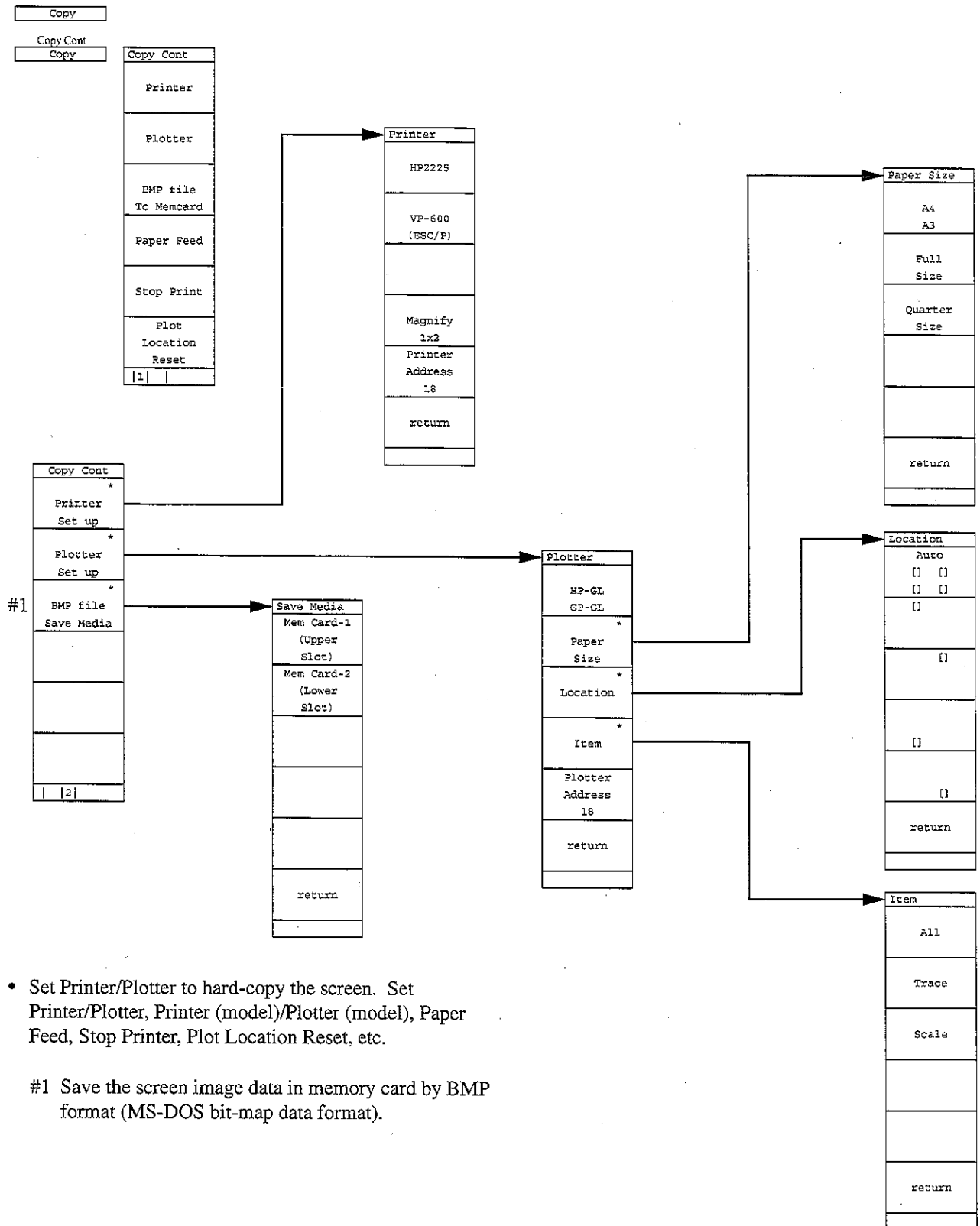

- Set Printer/Plotter to hard-copy the screen. Set Printer/Plotter, Printer (model)/Plotter (model), Paper Feed, Stop Printer, Plot Location Reset, etc.

#1 Save the screen image data in memory card by BMP format (MS-DOS bit-map data format).

APPENDIX A SOFT-KEY MENU

MS2665C Menu Tree (19 /25)

Panel Key — Top menu — Lower menus

Sound	Sound
	AM
	Narrow FM
	Wide FM
	Off
	Volume
	6

- Demodulate the received signal and monitor-output it from the speaker. Select AM, Narrow FM, Wide FM, TV (voice) and Volume.

#1 Sets whether the coupled settings for RBW, VBW, etc., in frequency and time domain, independent or common.

#2 Changes screen color pattern.

System	System
#1	Couple
	Common
	Independent
	Display
	Auto SWT
	Hi-Lvl-Acc
	Fast
	Power On
	State
	Erase
	Warm up
	Message
	1

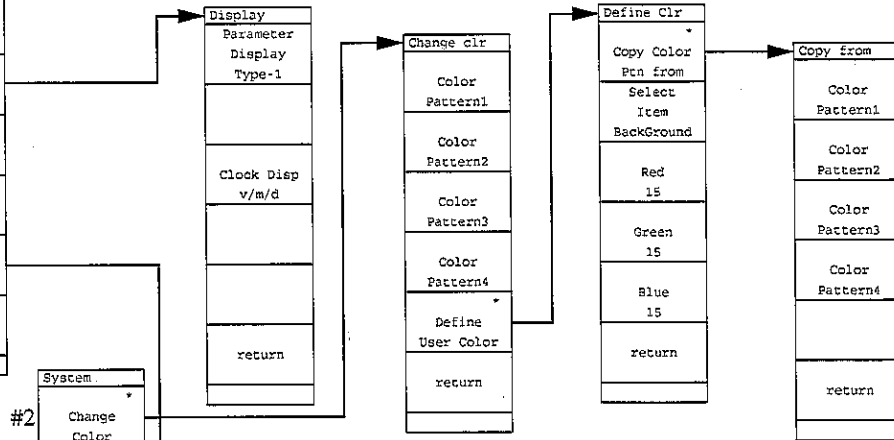

System	System
#2	Change Color
	LCD
	Brightness
	Zero Span
	Digital
	Analog
	FreqDomain
	Lock
	Unlock
	Count
	20
	Composite Mode
	13

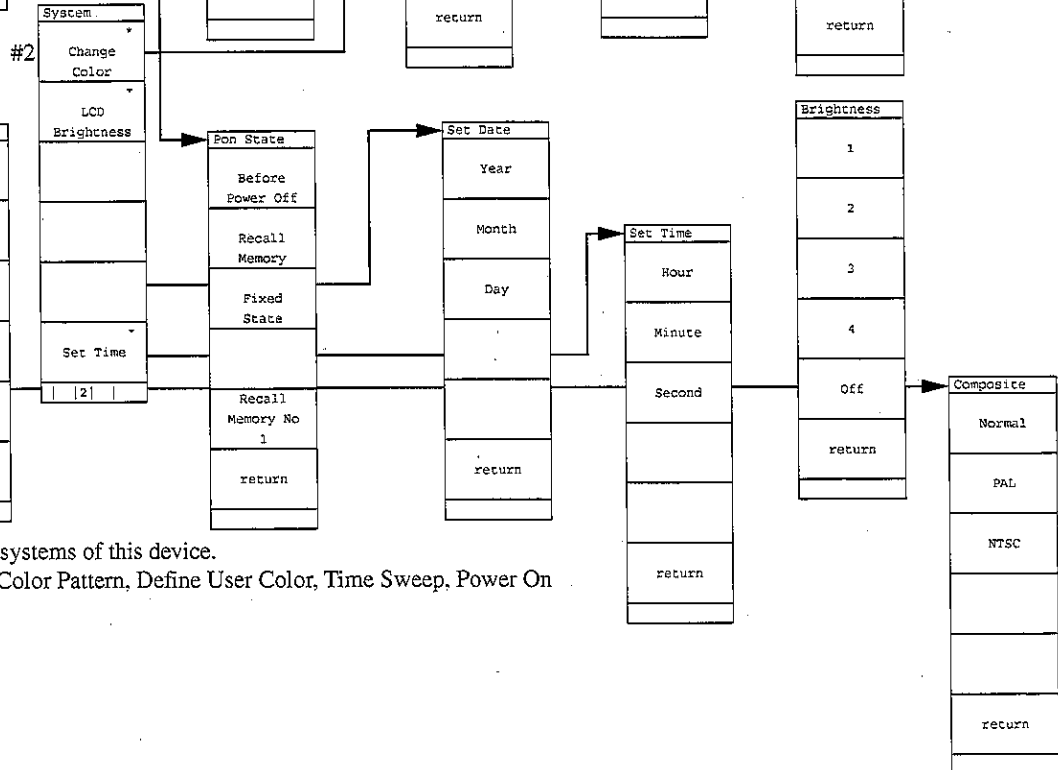

- Set various modes of systems of this device. Set Couple, Display, Color Pattern, Define User Color, Time Sweep, Power On State, etc.



MS2665C Menu Tree (20/25)

Panel Key | Top menu | Lower menus

Cal
Cal
All Cal
Level Cal
Freq Cal
FM Cal
Pre- * Selector Tuning
[1]

- Execute calibration. Select an item from All Cal, Level Cal, Freq Cal, and FM Demod Cal.

Preslctr
Auto tune
Manual -5
Preset
return

Cal
Freq Cal On Off
Cal status *
Mainte- nance *
2

<Calibration status screen>

MS2665C Menu Tree (21/25)

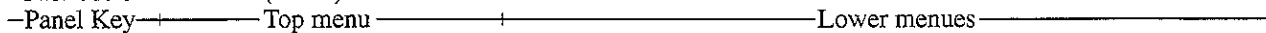

- Set interfaces for external devices to connect. Select RS232C, Centronics or GPIB, and set the RS232C interface, GPIB address, etc.

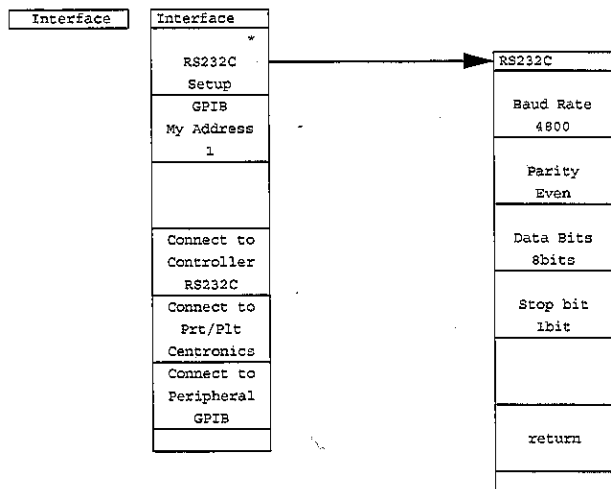

- Input a title to display on the screen.

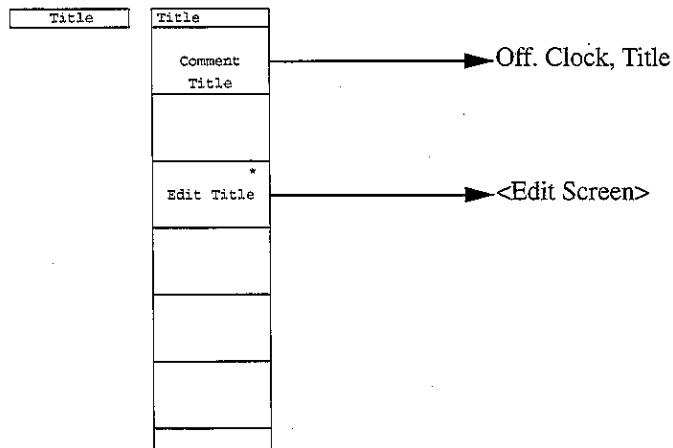

MS2665C Menu Tree (22/25)

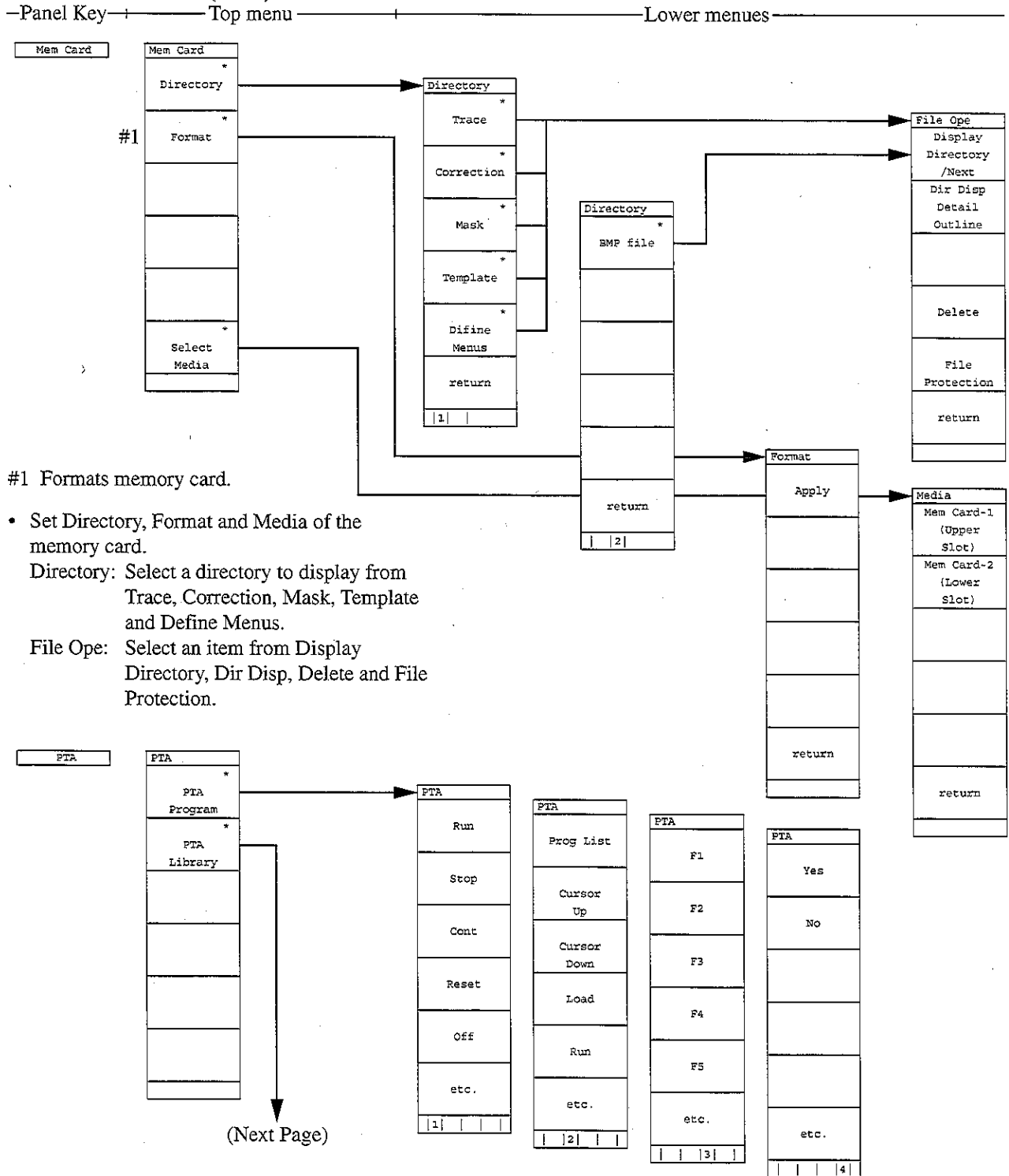

- Set PTA (personal test automation) that can build an auto measurement system without requiring external controllers.
- PTA Program: Select one from Run, Stop, Cont Reset, Prog List, Load, etc.
- PTA Library: Select one from Display/Run for the library program and Load/Check for the library file.

APPENDIX A SOFT-KEY MENU

MS2665C Menu Tree (23/25)

Panel Key | Top menu | Lower menus

(Previous Page) →

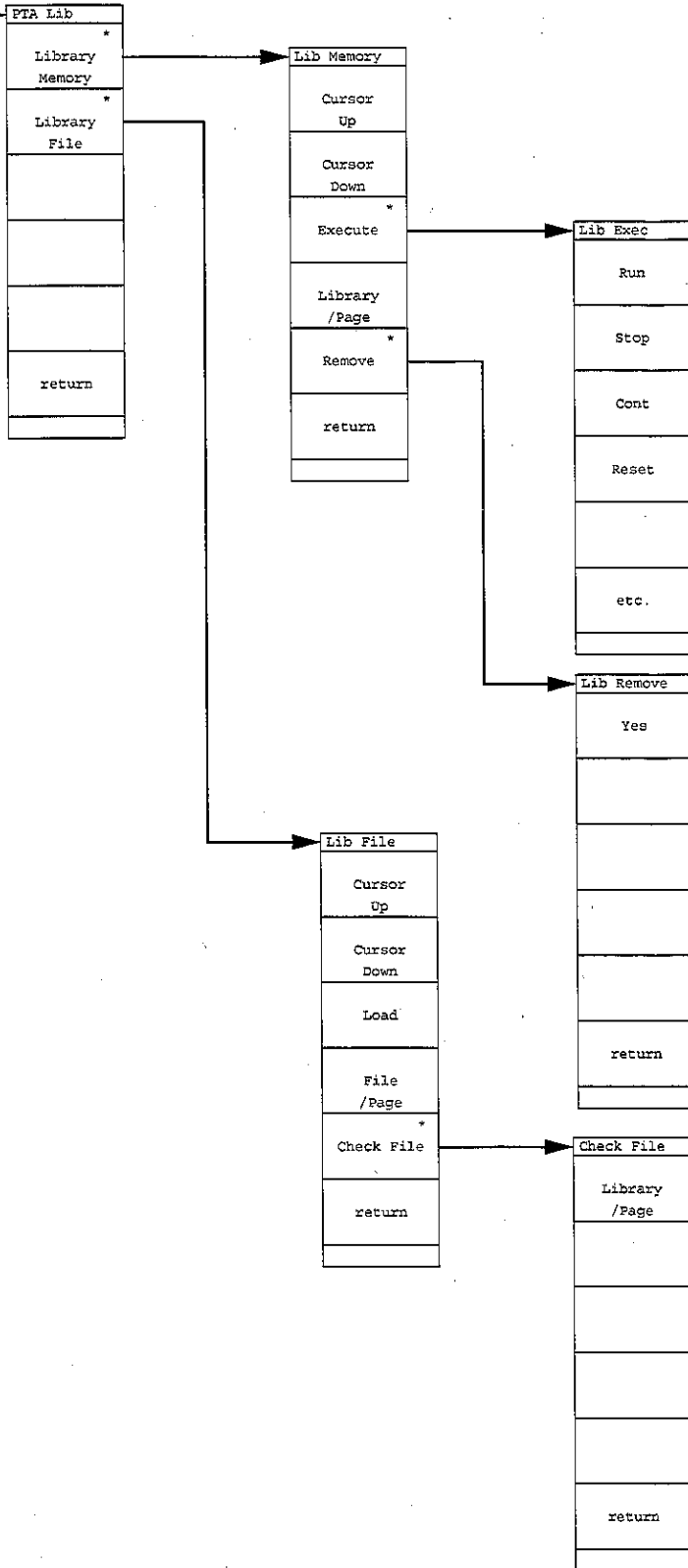

MS2665C Menu Tree (24/25)

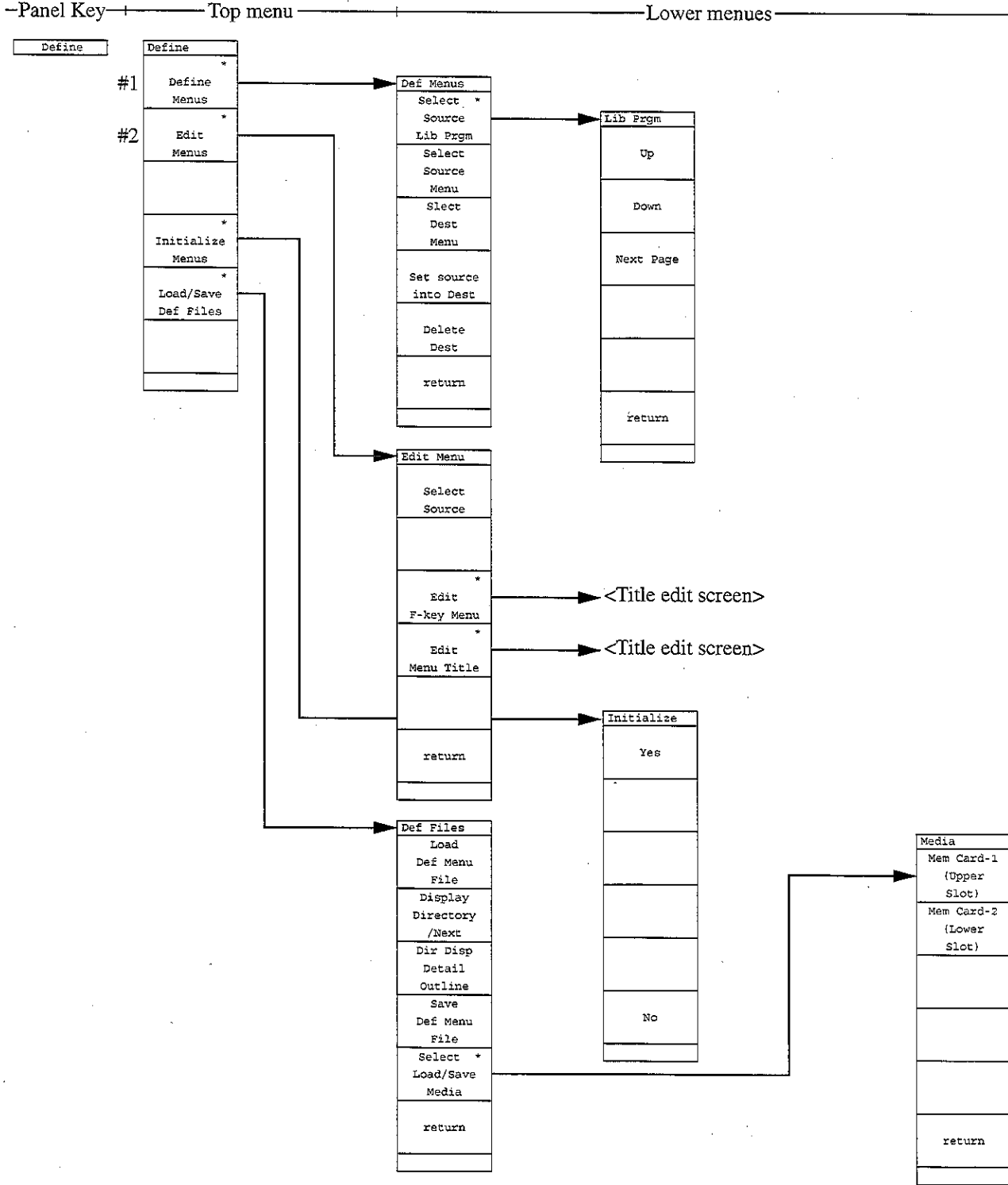

- Set Define, Edit, Initialize and Load/Save.
  - #1 Define Menus: Select one from Source Menu, Source Library, Destination Menu, etc., and set Definition/Delete for the user menu.
  - #2 Edit Menu: Select a source and edit Menu Title.

MS2665C Menu Tree (25/25)



Preset

Preset
Preset All
Preset Sweep Controll
Preset Trance Parameters
Preset Level Parameters
Preset Freq/Time Parameters

- Initialize measurement parameters. Select one from All, Sweep, Trace, Level and Freq/Time.

Hold

Local

MS2667C/68C Menu Tree (1/25)

Panel Key | Top menu | Lower menus

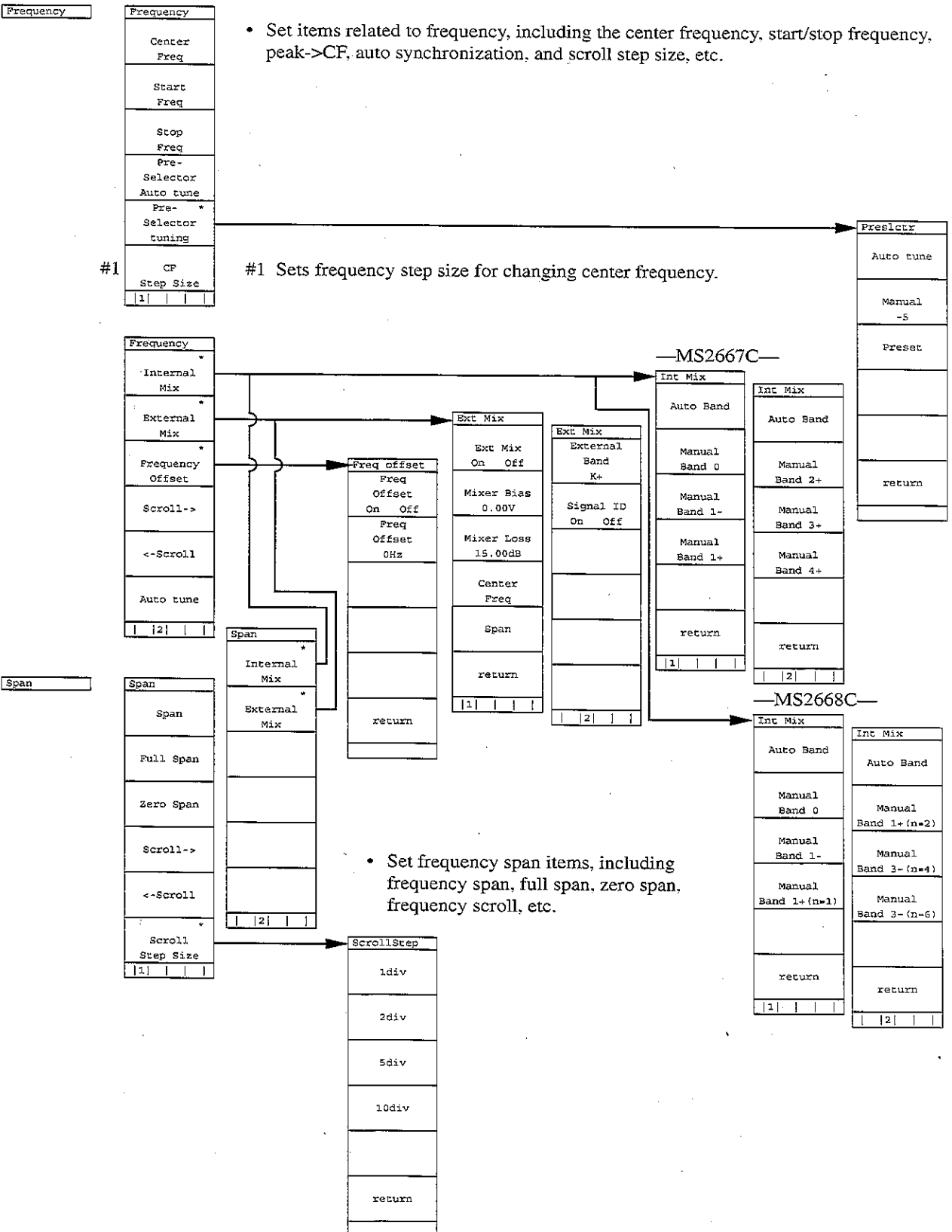

MS2667C/68C Menu Tree (2/25)

Panel Key — Top menu — Lower menus

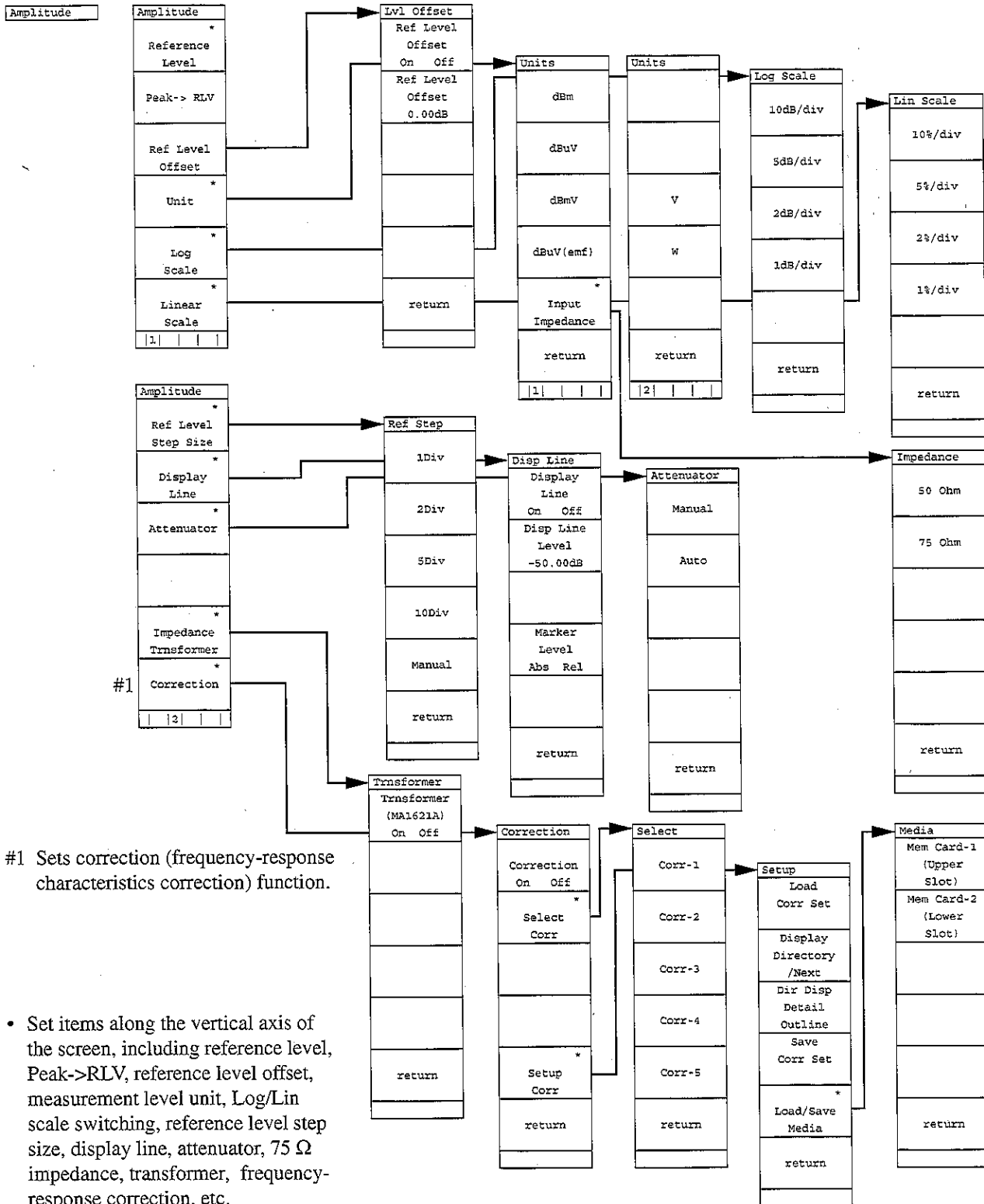



MS2667C/68C Menu Tree (3/25)

Panel Key | Top menu | Lower menus

RBW	RBW
	Manual
	Auto
	RB/Span Ratio On Off
	RB/Span Ratio 0.01
	RB, VB, SWT Auto
#1	All Auto

- Set the manual/auto of resolution bandwidth, and auto (RBW, VBW and SWP only) or all auto.
- Set Ratio of RBW to Span when RBW is Auto and Ratio Mode is "on".

#1 Sets RBW, VBW, Sweep Time, Atten all to Auto.

VBW

VBW
Manual
Auto
Filter Off
VB/RB Ratio 1.0
RB, VB, SWT Auto
All Auto

- Set the manual/auto of video bandwidth, and auto (RBW, VBW and SWP only) or all auto.

#2 Sets ratio of VBW to RBW when VBW is Auto.

Sweep Time

Sweep Time
Manual
Auto
RB, VB, SWT All Auto
All Auto

#2

- Set the manual/auto of sweep time, and auto (RBW, VBW and SWP only) or all auto.

Atten

Attenuator
Manual
Auto
All Auto

MS2667C/68C Menu Tree (4/25)

Panel Key | Top menu | Lower menus

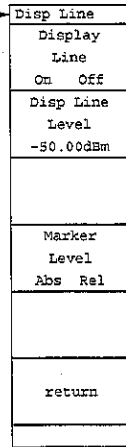
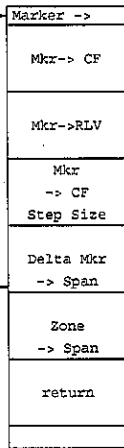
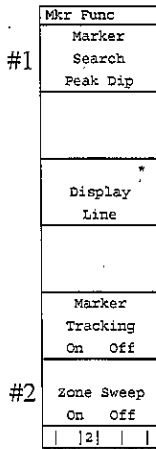
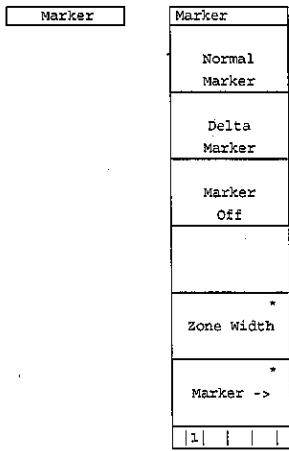

- Set the selection of normal/delta/no marker, zone marker width, marker->, marker search mode, display line, marker tracking On/Off, zone sweep On/Off, etc.

- #1 Selects whether to search for maximum (Peak) or minimum (Dip) value in zone marker.
- #2 Toggles zone sweep On/Off. Usually, the zone sweep is Off. At On, the sweep time is reduced by sweeping only the zone specified by the zone marker.

Multi Marker Marker

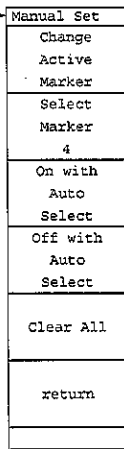
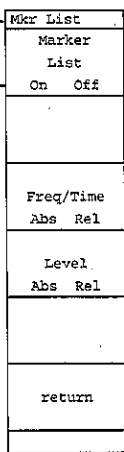
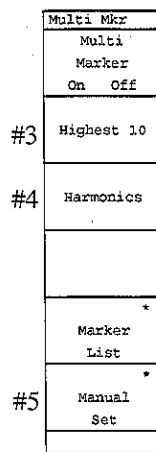

- Set multi-marker On/Off, 10 multi-marker, harmonic multi-marker, listing of multi-marker values, selection of necessary markers, etc.

- #3 Allocates up to 10 multi-markers sequentially from the peak level of the signal displayed on screen.
- #4 Allocates multi-markers to the harmonic signals of frequency indicated by current marker.
- #5 Function allowing user to select only multi-markers necessary for measurement.
- #6 Select "absolute value" or "relative value (display line)" to display marker level.

MS2667C/68C Menu Tree (5/25)

Panel Key — Top menu — Lower menus

Peak Search

Peak
Peak Search
Next Peak
Next Right Peak
Next Left Peak
Normal Marker
Delta Marker
1

- Set maximum level search, next peak, next right peak, next left peak, Marker->, minimum level search, next minimum level, search level resolution, threshold level On/Off, etc.

Dip
Dip Search
Next Dip
#2 Resolution 1.23 dB
* Threshold
* Marker ->
2

Threshold
Threshold On Off
Search Above Below
Threshold Level -50.00 dBm
return

- #1 Searches for minimum (Dip) level.
- #2 Sets peak-search level resolution.

Marker Peak Search

Marker ->
Mkr-> CF
Mkr->RLV
Mkr -> CF Step Size
Delta Mkr -> Span
Zone -> Span

Marker ->
Mkr-> CF
Mkr->RLV
Mkr -> CF Step Size
Delta Mkr -> Span
Zone -> Span
return

- Set marker value -> center frequency, marker value -> reference level, marker value -> CF step size, delta marker-> span, zone marker -> span, etc.

APPENDIX A SOFT-KEY MENU

MS2667C/68C Menu Tree (6/25)

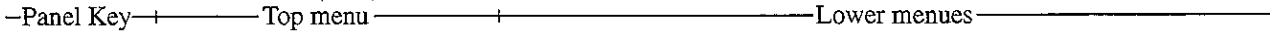

Peak  
->CF

Peak  
->RLV

Single

Continuous  
Single

User

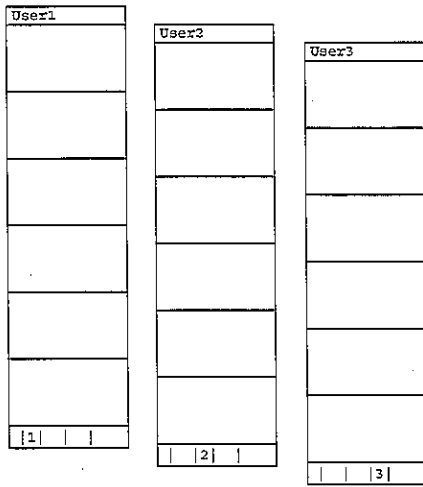

- The soft-key menu defined by the user is displayed. (See "User Define".)

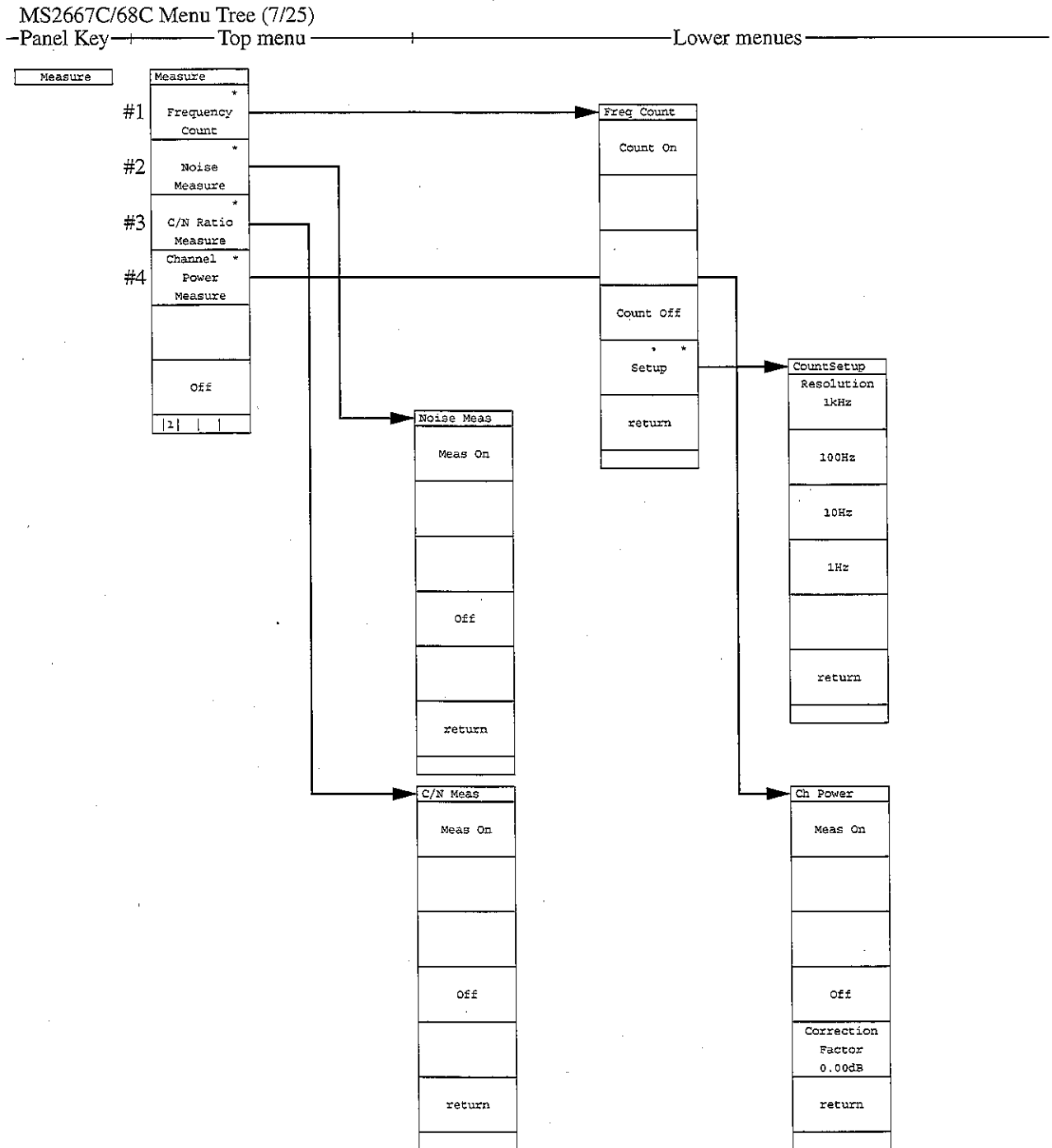

- Perform measurement according to various applications:
  - #1 Frequency Count: Measure marker frequency with a high resolution. Select resolution from 1 kHz, 100 Hz, 10 Hz and 1 Hz.
  - #2 Noise Measure: Measure the noise power within zone marker.
  - #3 C/N Ratio Measure: Measure the ratio of carrier signal and noise power. Reference marker of the delta marker shall be set to the carrier, and marker's zone width specifies the power measured.
  - #4 Channel Power Measure: Power within the band indicated by zone marker is measured. It is possible to set an arbitrary calibration value.

MS2667C/68C Menu Tree (8/25)

Panel Key | Top menu | Lower menus

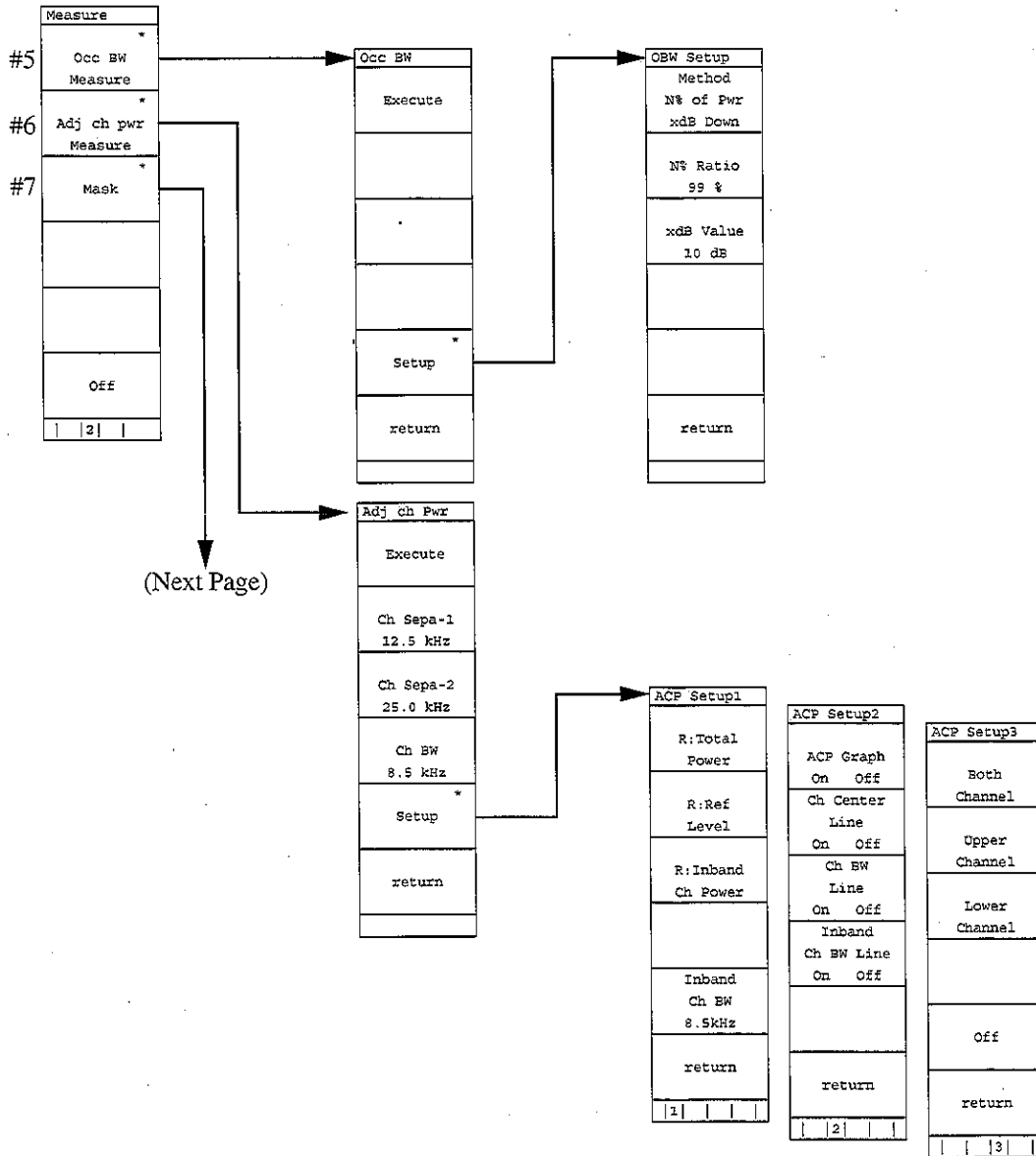

- #5 Occ BW Measure: Measure the occupied bandwidth. Select the X dB DOWN or N % of POWER mode.
- #6 Adj ch pwr Measure: Measure leak power from adjacent channels. Select Channel Separate, Channel Bandwidth and Measurement Mode (Method), On/Off of ACP Graph, On/Off of Channel Center Line and On/Off of Channel BW Line, Upper Channel, Lower Channel or Both Channel, etc.
- #7 Mask: Set Standard Line of the frequency domain and judge Good/NG in relation to the standard line. Select Mask Table, Mask Movement, Measurement Mode, Mask Table Preparation, Load/Save of Mask Table, etc.

MS2667C/68C Menu Tree (9/25)

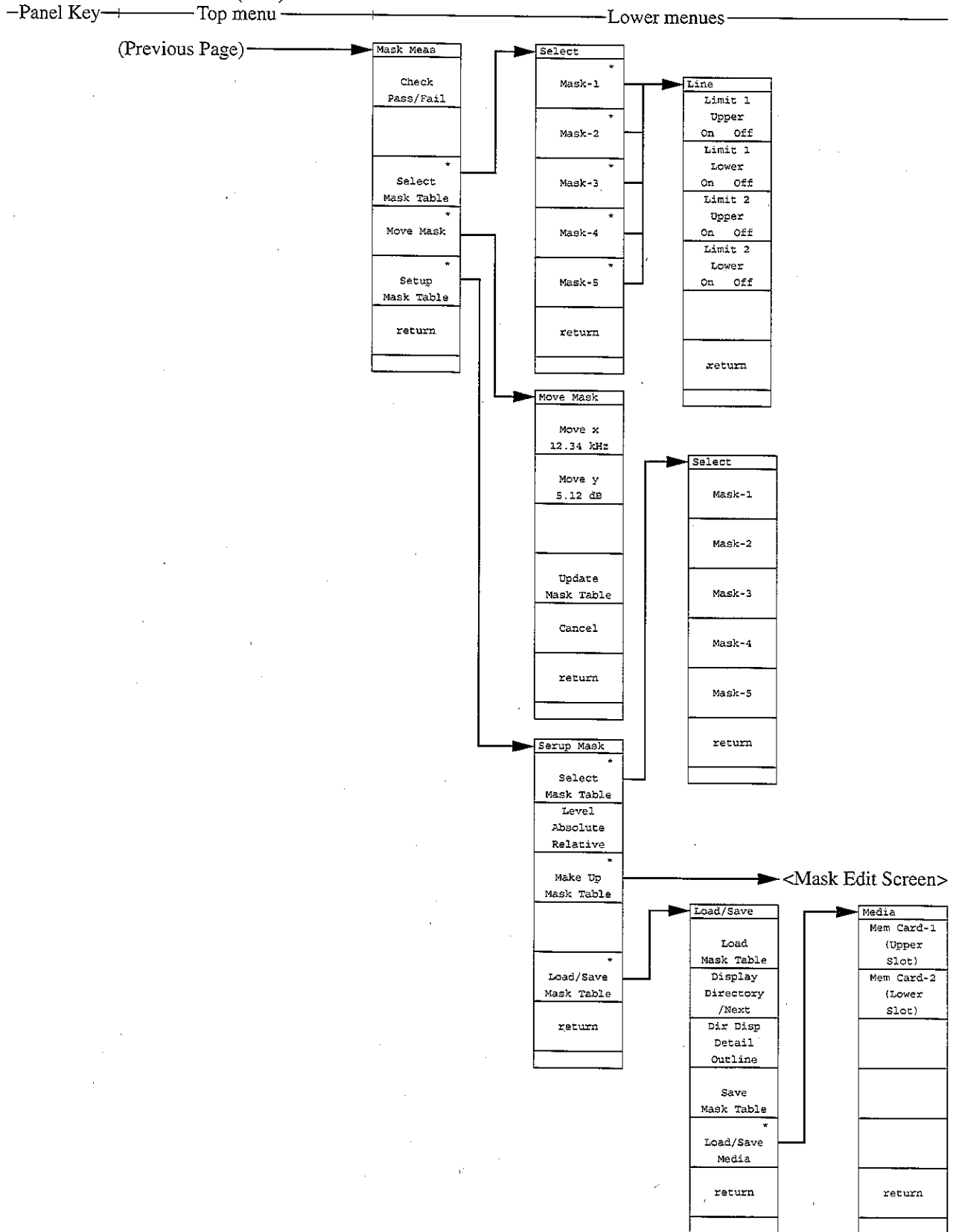

MS2667C/68C Menu Tree (10/25)

Panel Key — Top menu — Lower menus

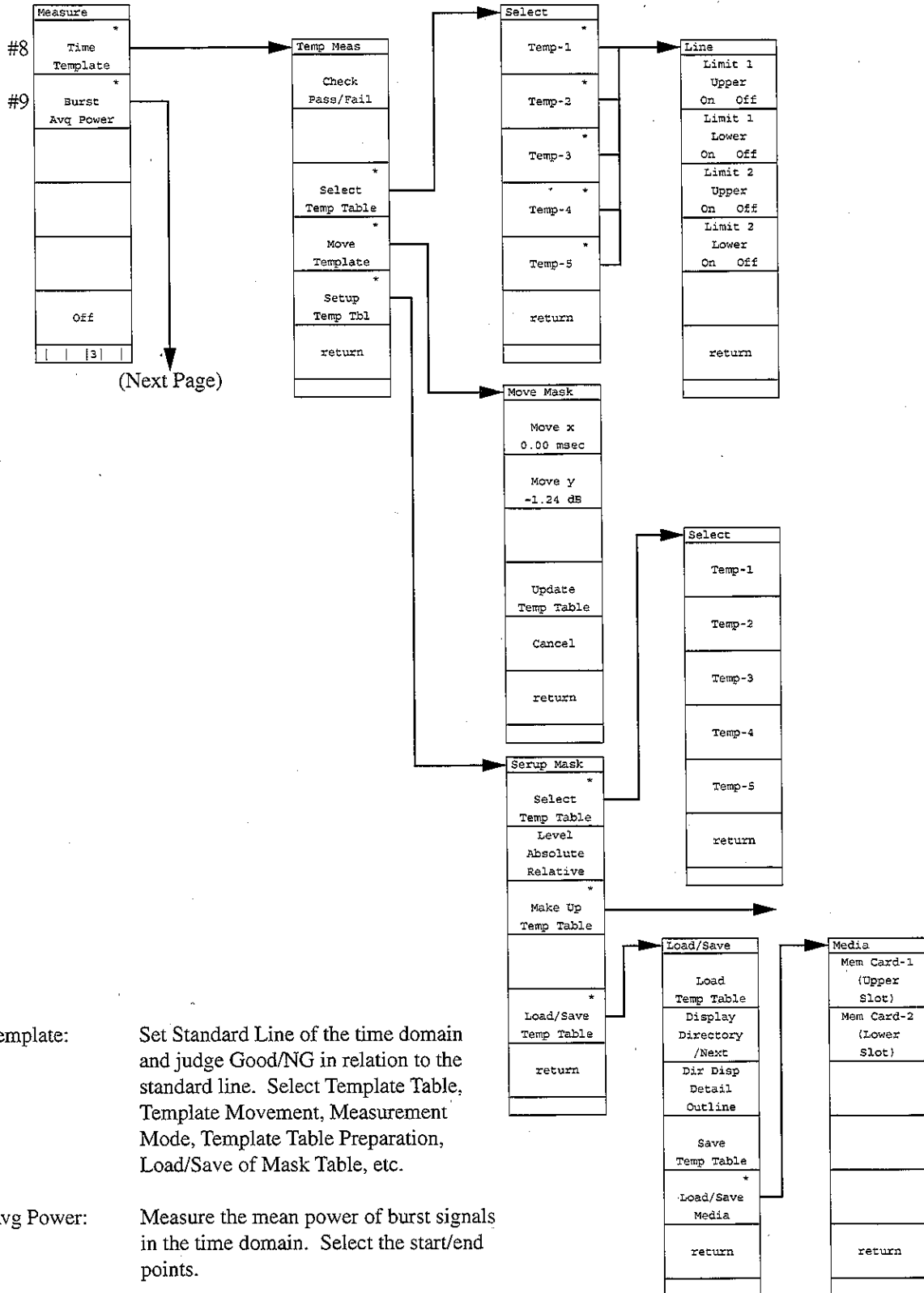

#8 Time Template: Set Standard Line of the time domain and judge Good/NG in relation to the standard line. Select Template Table, Template Movement, Measurement Mode, Template Table Preparation, Load/Save of Mask Table, etc.

#9 Burst Avg Power: Measure the mean power of burst signals in the time domain. Select the start/end points.



MS2667C/68C Menu Tree (11/25)

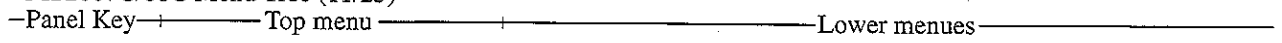

(Previous Page) →

Burst Fwr
Execute
Start Point 100
Stop Point 100
return

MS2667C/68C Menu Tree (12/25)

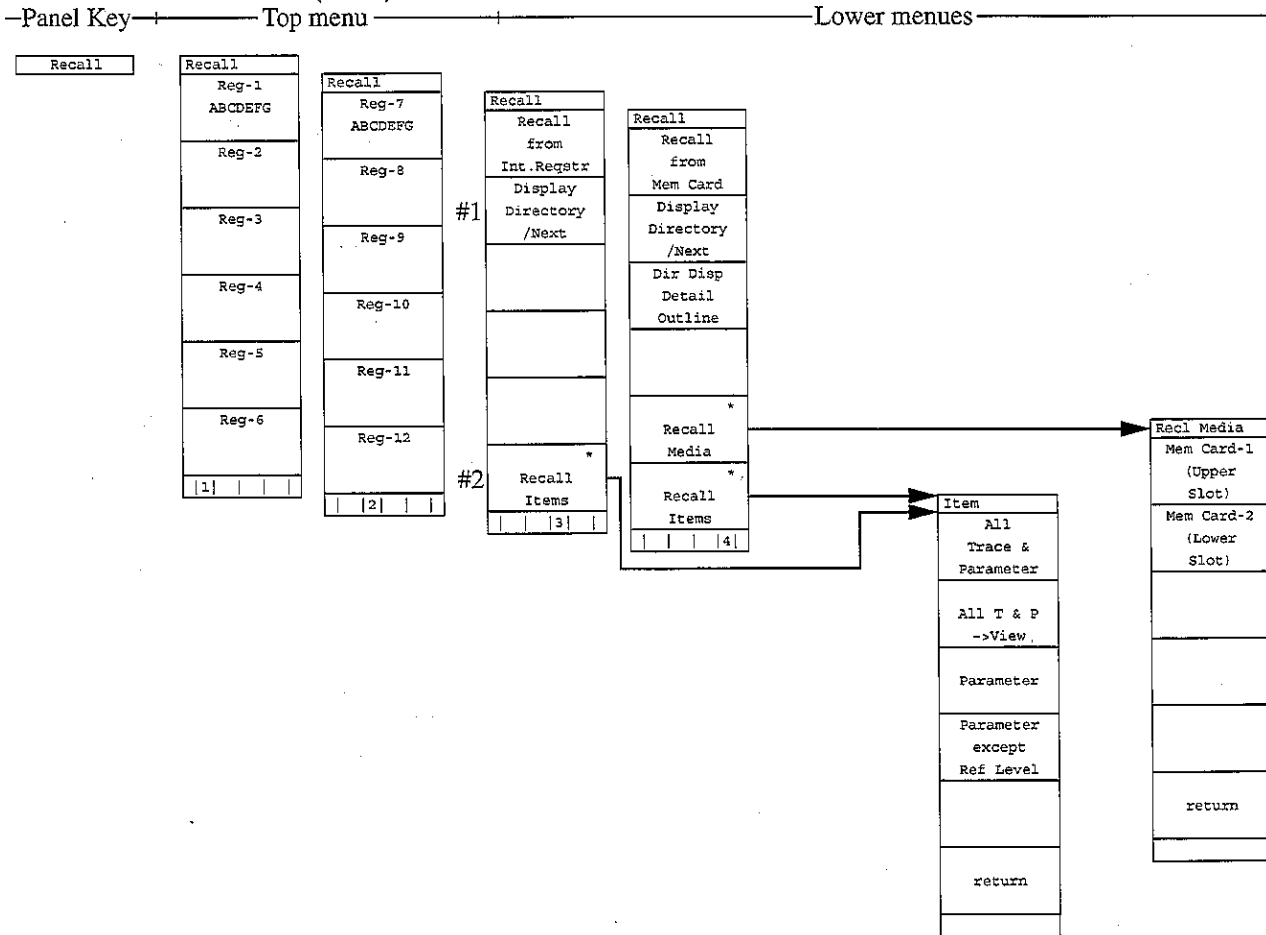

- Read out trace waveform/parameters from the internal memory or memory card. Select recall addresses and media/items, and display file directories.

#1 Displays list of internal-memory directories.

#2 Specifies items to be recalled (trace waveform, parameter, etc.).

MS2667C/68C Menu Tree (13/25) — Panel Key — Top menu — Lower menus —

Save  
Recall

Save
Save to Int. Regstr
Display Directory /Next
1

- Save trace waveform/parameters to the internal memory or memory card. Select saved media, and display file directories.

Save
Save to Mem Card
Display Directory /Next
Dir Disp Detail Outline
Save Media *
2

Save Media
Mem Card-1 (Upper Slot)
Mem Card-2 (Lower Slot)
return

Save
Save BMP file to Memcard
Display Directory /Next
Dir Disp Detail Outline
Save Media *
3

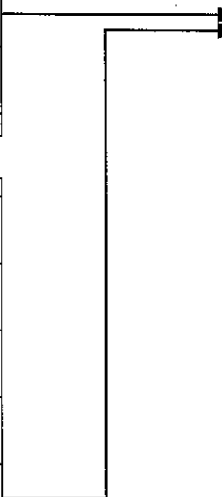

MS2667C/68C Menu Tree (14/25)

Panel Key ————— Top menu ————— Lower menus —————

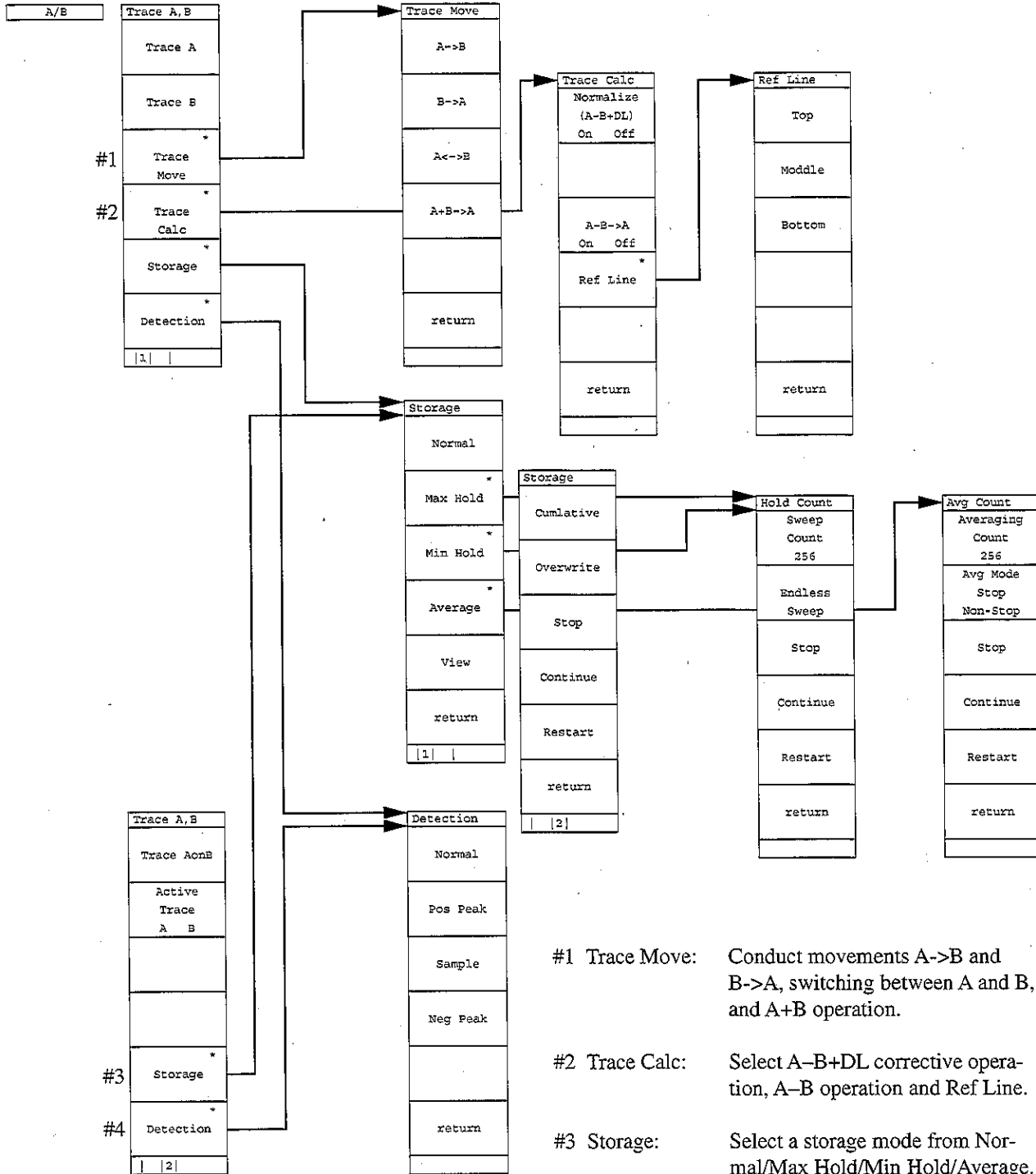

- Select Trace A/B, movement between Trace A/B, sum/difference operation between Trace A/B and Ref Line, and designate the storage and detection modes and Active Trace.

MS2667C/68C Menu Tree (15/25)

Panel Key | Top menu | Lower menus

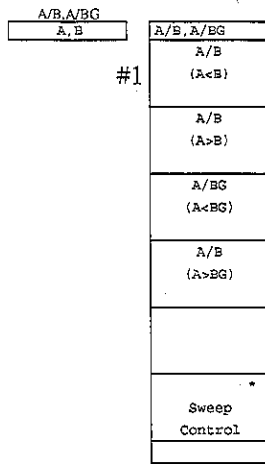

- Simultaneously display two waveforms, namely Trace A and Trace B or Trace A and Trace BG (peripheral spectrum containing Trace A). The large display is Main Trace and the small one is Sub Trace; select which to display as Main Trace (or Sub Trace). Sweep Control: Set Stop/Continuous/Restart for sweep and Stop/Write for Sub Trace.

#1 Displays two traces A and B simultaneously at top and bottom of screen. The trace-B display is the larger at this time.

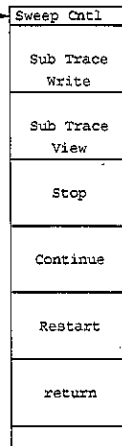

MS2667C/68C Menu Tree (16/25)

Panel Key | Top menu | Lower menus

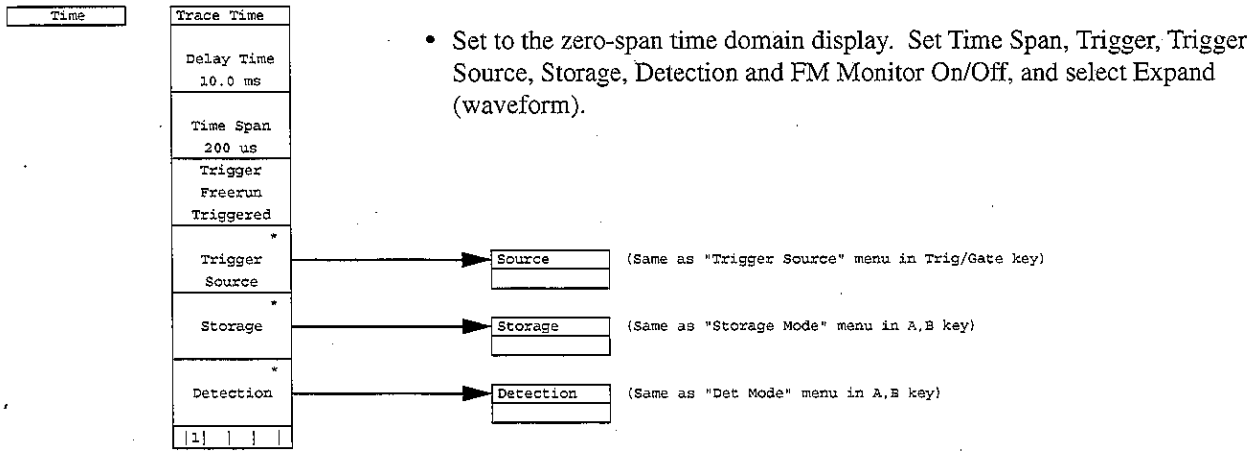

- Set to the zero-span time domain display. Set Time Span, Trigger, Trigger Source, Storage, Detection and FM Monitor On/Off, and select Expand (waveform).

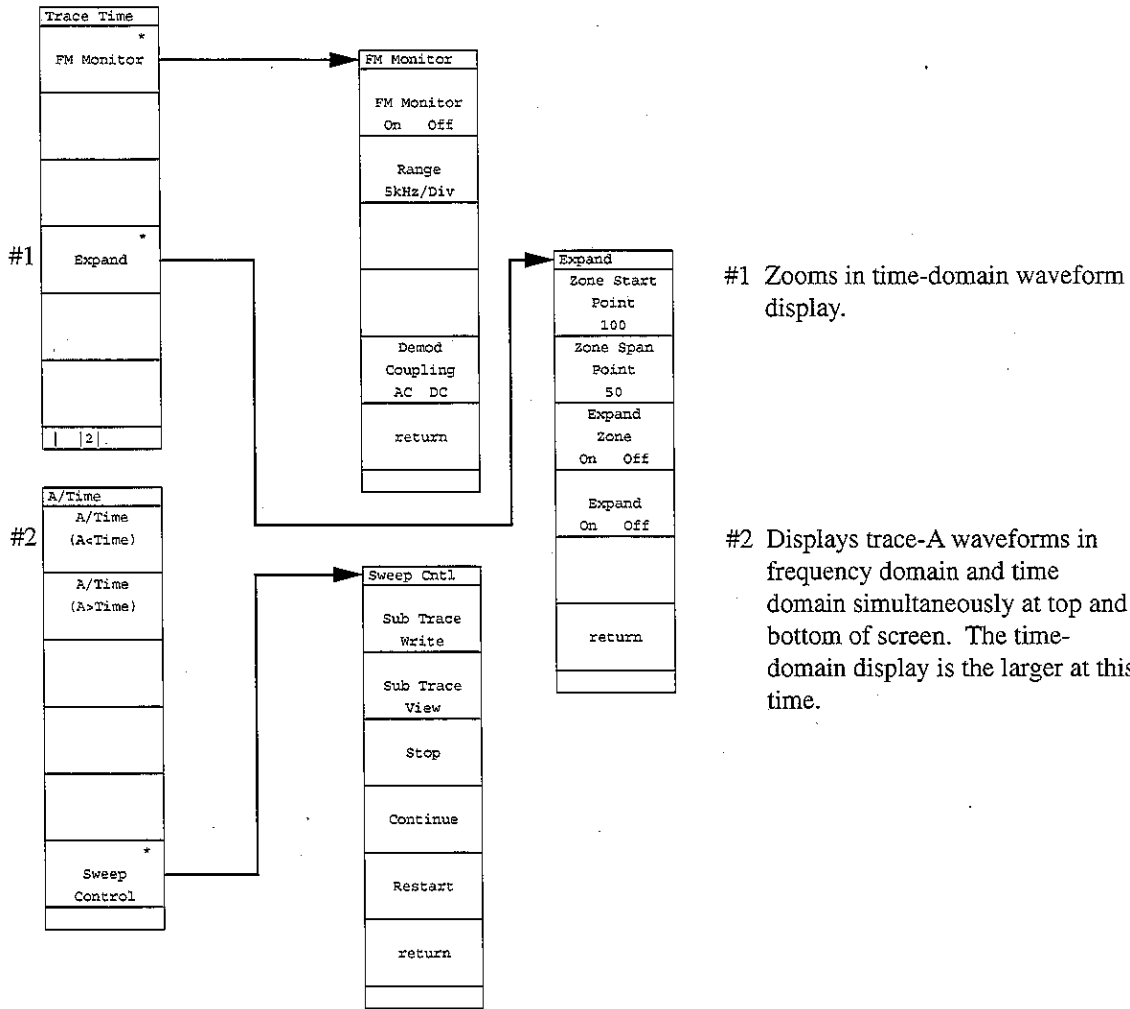

#1 Zooms in time-domain waveform display.

#2 Displays trace-A waveforms in frequency domain and time domain simultaneously at top and bottom of screen. The time-domain display is the larger at this time.

- Simultaneously display waveforms of Trace a and Time Domain. Which to display as Main Trace (or Sub Trace) can be selected.

MS2667C/68C Menu Tree (17/25)

Panel Key ——— Top menu ——— Lower menus ———

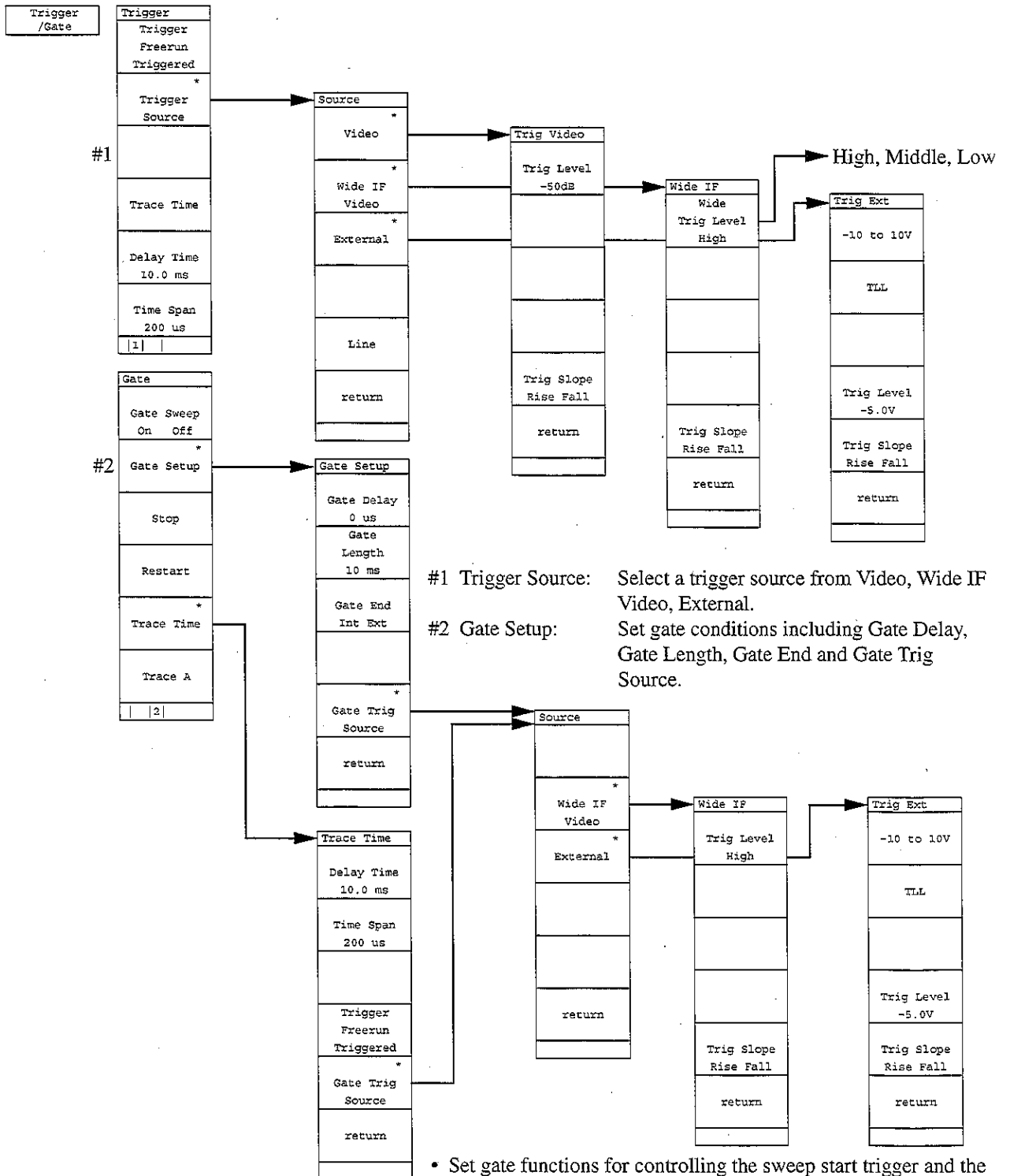

- #1 Trigger Source: Select a trigger source from Video, Wide IF Video, External.
- #2 Gate Setup: Set gate conditions including Gate Delay, Gate Length, Gate End and Gate Trig Source.

- Set gate functions for controlling the sweep start trigger and the writing of waveform data. Set the trigger mode, trigger source, trace time, delay time and time span. Select On/Off, Stop and Restart of Gate Sweep.

MS2667C/68C Menu Tree (18/25)

Panel Key | Top menu | Lower menus

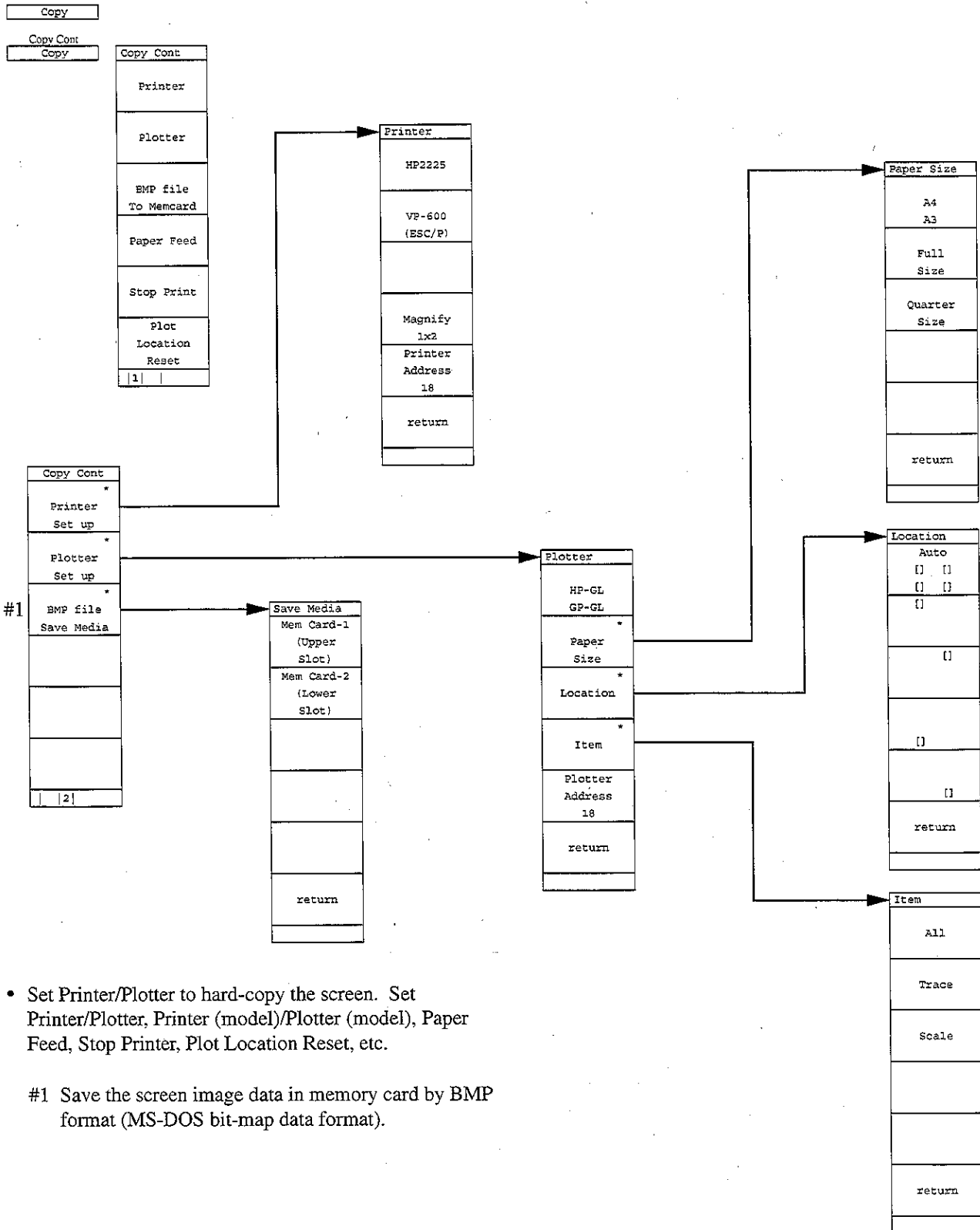

- Set Printer/Plotter to hard-copy the screen. Set Printer/Plotter, Printer (model)/Plotter (model), Paper Feed, Stop Printer, Plot Location Reset, etc.

#1 Save the screen image data in memory card by BMP format (MS-DOS bit-map data format).



MS2667C/68C Menu Tree (19 /25)

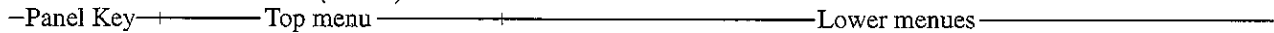

Sound
Sound
AM
Narrow FM
Wide FM
Off
Volume
6

- Demodulate the received signal and monitor-output it from the speaker. Select AM, Narrow FM, Wide FM, TV (voice) and Volume.

#1 Sets whether the coupled settings for RBW, VBW, etc., in frequency and time domain, independent or common.

#2 Changes screen color pattern.

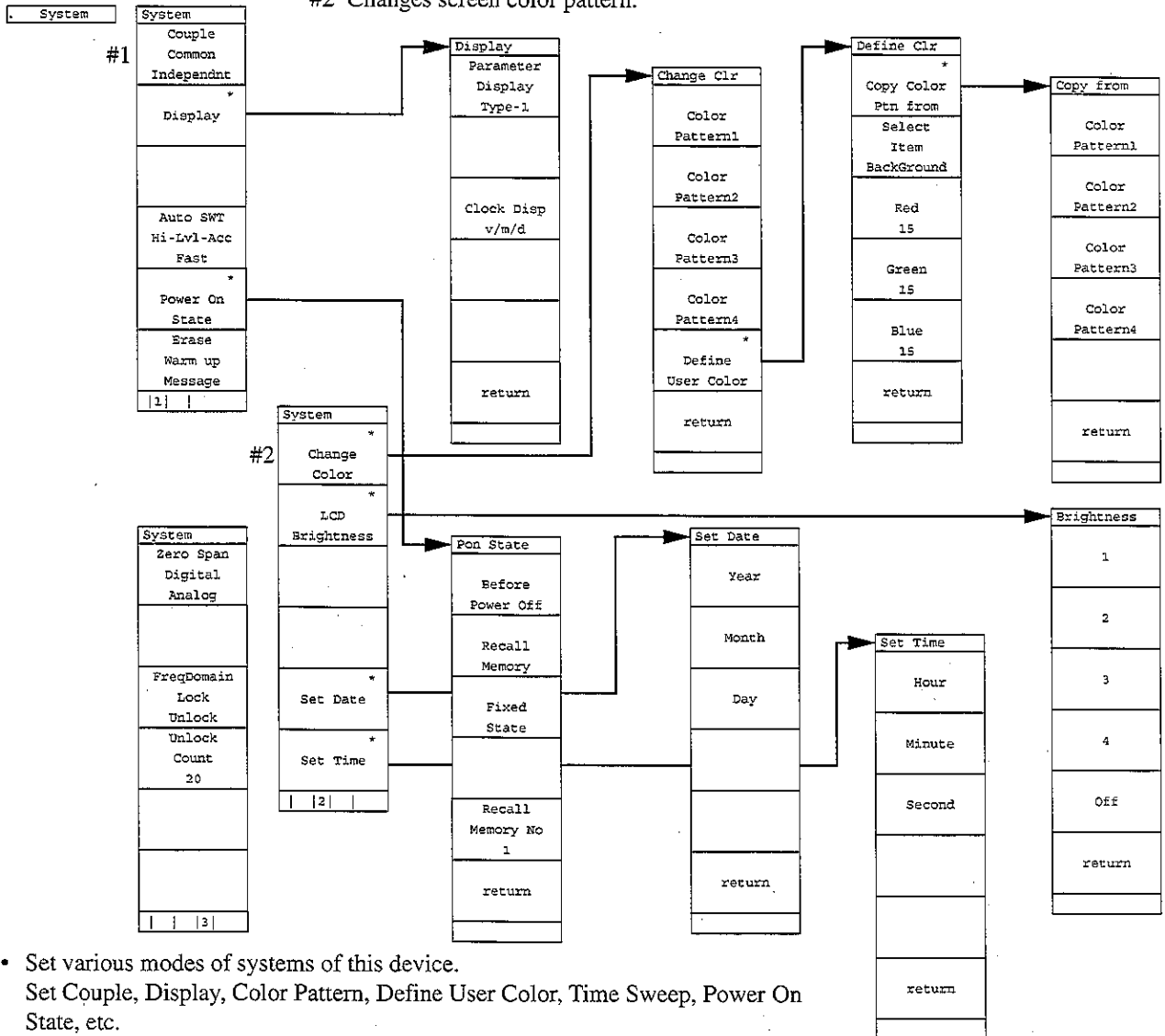

- Set various modes of systems of this device. Set Couple, Display, Color Pattern, Define User Color, Time Sweep, Power On State, etc.

MS2667C/68C Menu Tree (20/25)

Panel Key | Top menu | Lower menus

Cal	Cal
	All Cal
	Level Cal
	Freq Cal
	FM Cal
	Pre- * Selector Auto tune
	Pre- * Selector Tuning
	1

- Execute calibration. Select an item from All Cal, Level Cal, Freq Cal, and FM Demod Cal.

Preslctr
Auto tune
Manual -5
Preset
return

Cal
Freq Cal On Off
Cal status *
Mainte- nance *
2

<Calibration status screen>

MS2667C/68C Menu Tree (21/25)

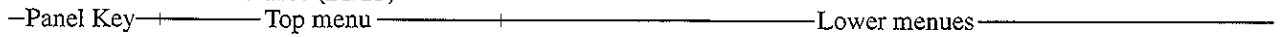

- Set interfaces for external devices to connect. Select RS232C, Centronics or GPIB, and set the RS232C interface, GPIB address, etc.

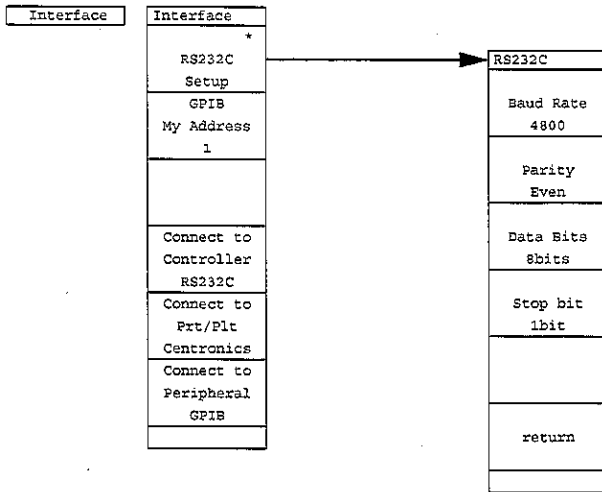

- Input a title to display on the screen.

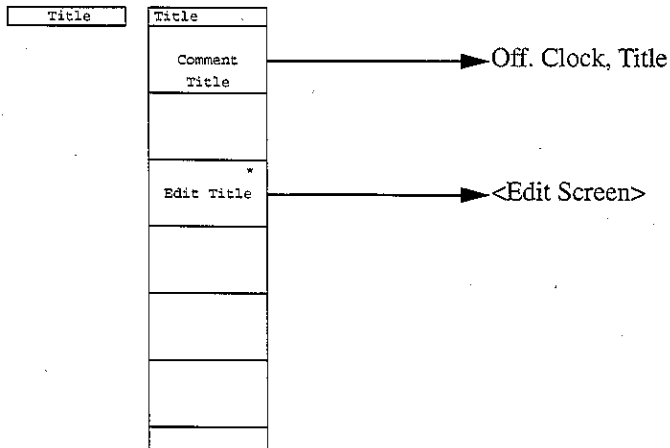

MS2667C/68C Menu Tree (22/25)

Panel Key | Top menu | Lower menus

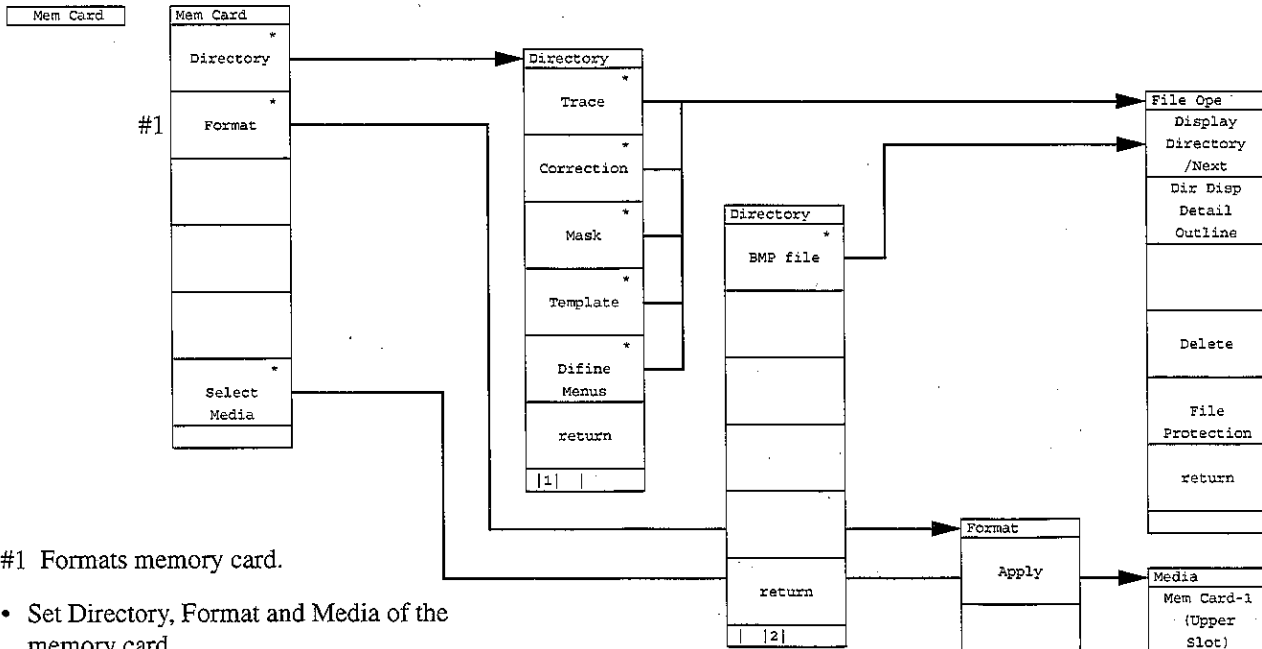

#1 Formats memory card.

- Set Directory, Format and Media of the memory card.  
 Directory: Select a directory to display from Trace, Correction, Mask, Template and Define Menus.  
 File Ope: Select an item from Display Directory, Dir Disp, Delete and File Protection.

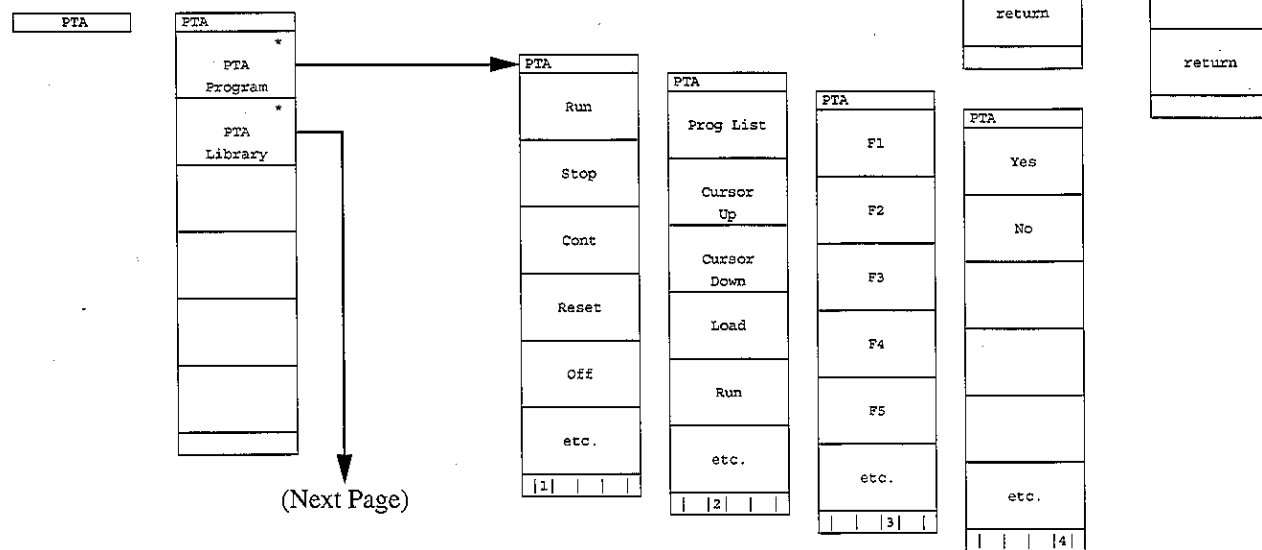

- Set PTA (personal test automation) that can build an auto measurement system without requiring external controllers.  
 PTA Program: Select one from Run, Stop, Cont Reset, Prog List, Load, etc.  
 PTA Library: Select one from Display/Run for the library program and Load/Check for the library file.

MS2667C/68C Menu Tree (23/25)

-Panel Key+-----Top menu-----Lower menus-----

(Previous Page) →

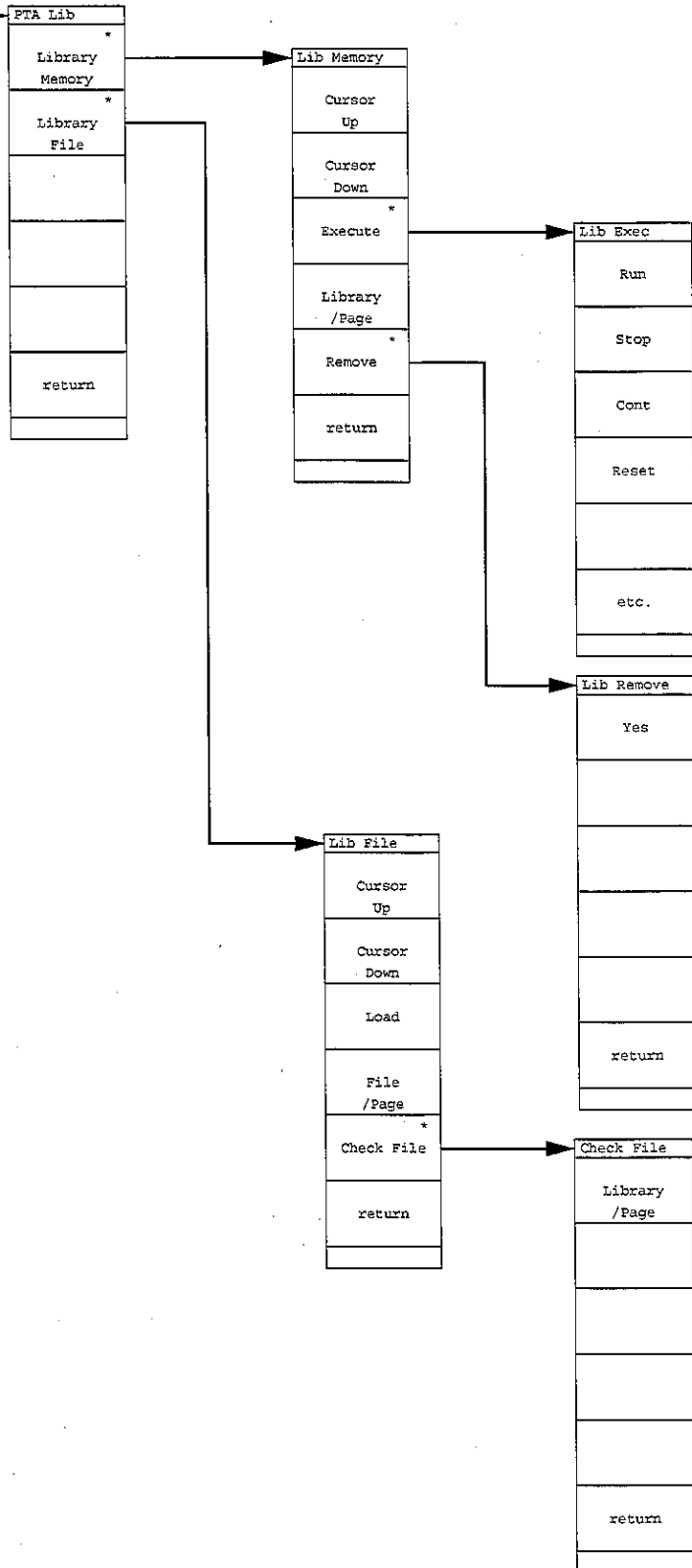

MS2667C/68C Menu Tree (24/25)

Panel Key ← Top menu ← Lower menus

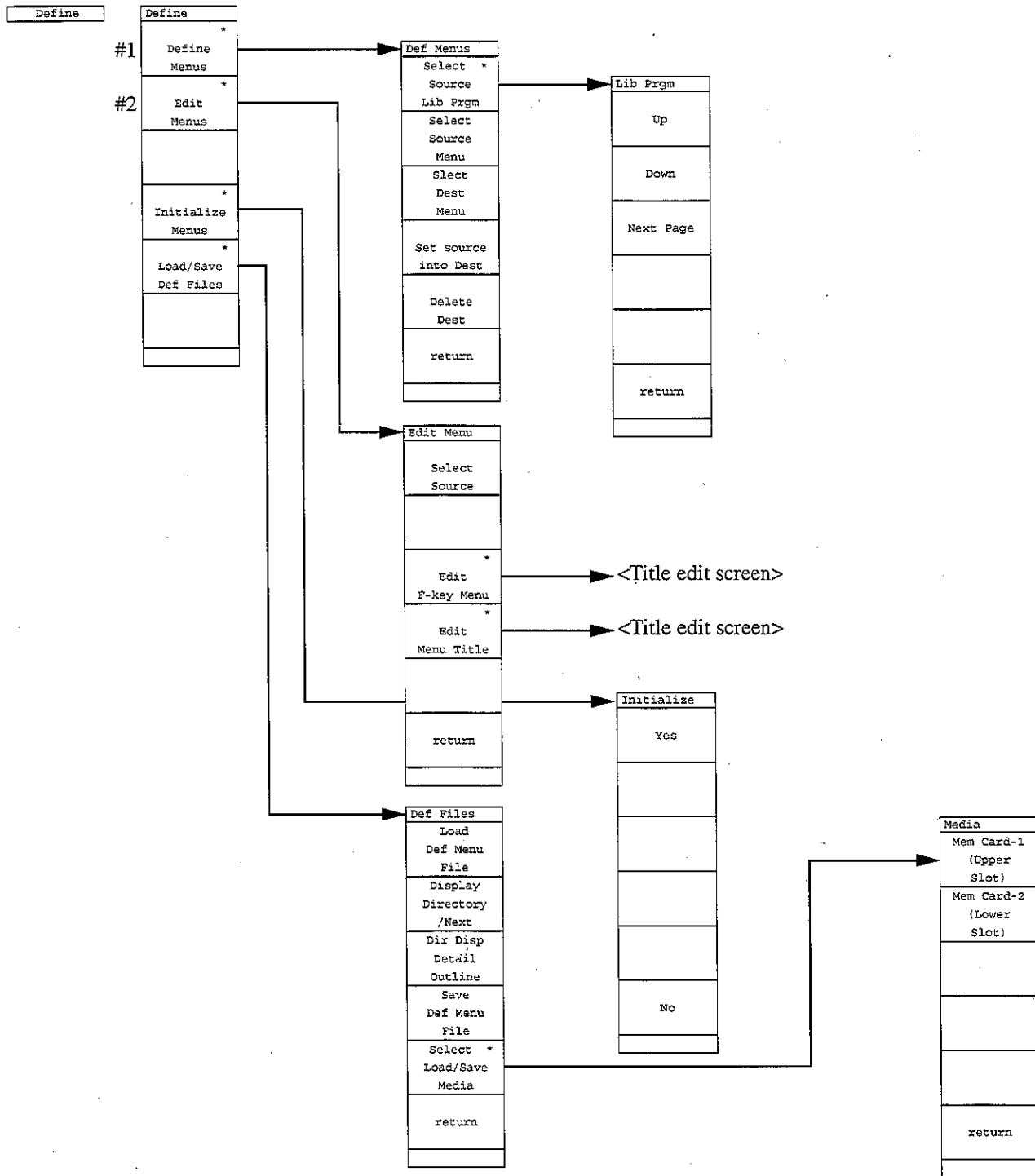

- Set Define, Edit, Initialize and Load/Save.
  - #1 Define Menus: Select one from Source Menu, Source Library, Destination Menu, etc., and set Definition/Delete for the user menu.
  - #2 Edit Menu: Select a source and edit Menu Title.

MS2667C/68C Menu Tree (25/25)

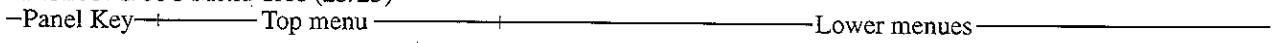

Preset	Preset
	Preset All
	Preset Sweep Controll
	Preset Trance Parameters
	Preset Level Parameters
	Preset Freq/Time Parameters

- Initialize measurement parameters. Select one from All, Sweep, Trace, Level and Freq/Time.

Hold

Local





## APPENDIX B

### KEYWORDS INDEX

The following lists the main keywords used in this operation manual and the number of the pages on which they are used. Use it to search for the soft keys, function descriptions, etc.

# [KEYWORDS INDEX]

Keyword	Page
→CF	3-22
→RLV	3-22
←Scroll	2-6
1 div	2-6 3-4
10%/div, 10dB/div	2-10
50Ω,75Ω	2-16
*	3-14
A) A on B	5-8
A/BG	5-11
A/Time	5-14
A+B→A	5-6
A-B On Off	5-7
A/B, A/BG	5-9
A/BG	5-9
A<Time	5-14
Above Below	3-21
Abs	3-10
Absolute Value	3-10 3-12
AC or DC Coupling	5-30
Active Marker	3-13 3-14
Active Trace	5-8
Active Trace A B	5-8
Address	11-6
add	5-6
Adj ch pwr Measure	13-6
Adjacent Channel Leakage Power	13-6 13-28
All Auto	7-4
All Cal	8-4
All Trace&Parameter	10-9
AM	11-12
Atten	7-8
Attenuator	2-16
Auto mode	7-5 7-7 7-8
Auto Select	3-14
Auto SWT	9-10
Auto tune	4-4

Keyword	Page
Automatic Calibration Function	8-3
Automatic Tuning	4-4
A>B	5-9
A>BG	5-9
Average	5-15 5-17 5-18
averaging	5-20
Averaging Count	5-18
Averaging Function	5-18
averaging function	5-19
Avg Mode Stop Non-Stop	5-18
A→B	5-6
A↔B	5-6
B) Back Ground (BG)	4-4
Before Power Off	9-10
before the trigger	5-12
Below	3-21
BG zone	5-4
Blue	9-8
Bottom	5-7
Burst Average Power	13-7
Burst Avg Power	13-7
burst wave	6-15
burst wave gate control signal	6-8
B→A	5-6
C) C/N Ratio	13-5 13-8
C/N Ratio Measure	13-5 13-8
CAL	8-3
Cal Status	8-4
Calc	5-7
calculates the average data	5-18
Calibration Function	8-3
Carrier-Off	13-27
Center	2-3
CF Step Size	2-6
Ch BW	13-6
Ch Sepa-1	13-6
Chack Pass/Fall	13-6
Change Active Marker	3-14
Change Color	9-8

Keyword	Page	Keyword	Page
Check File	12-5	Delta Marker	3-8
Check Pass/Fail	13-6	Delta Mkr→Span	3-25
Clear	12-9	Demod Coupling AC DC	5-30
Clear All	3-15	destination	12-7
Clock Disp	9-6	Detail	2-17 10-7 10-8
Color Patern	9-7	Detecting Peaks	4-3
Comment	11-11	Detection	5-12 5-23
Composite Out	9-10	Detection Mode	5-22 5-23
Connect to Controller	11-7	digital averaging	5-20
Connect to Prt/Plt	11-7	Dip	3-9
Continue	5-10 5-17	Dip Search	3-19
Continuous	6-3	Dir Disp Detail	10-5
Continuous Sweep Mode	6-3	Dir Disp Outline	10-5
Copy	1-9	Direct Plotting	11-3
Copy Color Ptn	9-8	Directory	10-10
Copy Cont	1-9 11-4	Directory Display Screen	10-6
Corr-1	8-8	Directory/Next	10-5
Correction	2-17 8-7	Disp Line Level	3-21
Correction Coefficient	2-17	Display	9-6
correction factor	8-8	Display Directory	2-17 10-5
Count	13-4	Display Line	3-10 3-21
Coupled Common	9-4	display line	5-7
Coupled Function	7-3	Display modes	5-3
Coupled Function Common	9-4	Display Type	9-6
Coupled Independent	9-4	E) Edit Menu	12-6
Cumulative	5-16 5-17	Edit Title	11-11
current marker	3-4 3-7	Entry area	1-4
Cursor Down	12-4 12-5	Expands and displays	5-12
Cursor Up	12-4 12-5	EX1 to EX5	12-4
D) Date	9-11	Execute	12-5 13-5 13-7
dBc/Hz	13-9	Executing Hard Copy	11-8
dBm/ch	13-11	Expand	5-12
dB $\mu$ V, dBmV	2-9 2-11	Expand On	5-28
DC coupling	5-30	Expand zone	5-4
Define	12-6	Expand Zone On Off	5-28
Define Menues	12-6 12-7	expansion zone	5-28
Define User Color	9-8	External	6-9
Delay Time	5-12 6-10	External Mixer	14-3
Delete	10-11 12-9	External Trigger	6-8
Delete Dest	12-7		

APPENDIX B KEYWORDS INDEX

	Keyword	Page		Keyword	Page	
F)	File	10-11	I)	Impedance transformer	2-16	
	file deletion	10-10		Independent	9-4	
	File Directory	10-8		Initialize Menues	12-6	
	File/Page	12-5		Input Impedance	2-16	
	Filter Off	7-7		Insert	12-9	
	Fixed State	9-10		instantaneous signal level	5-24	
	FM	11-12		Interface	1-9 11-7	
	FM Cal	8-4		Item	9-8 11-6	
	FM Monitor	5-12 5-30		L)	Leakage Power Measurement	13-27
	Format	10-10			Level Abs Rel	3-12
	Freerun	6-5			Level Cal	8-4
	freerun or trigger sweep	5-12			Level Correction	8-7
	Freq/Time Abs Rel	3-12			Level Frequency	2-17
	Frequency	13-4			Level Frequency Correction Coefficient	2-17
	Frequency Count	1-8			Level Range	2-9
	Frequency deviation	5-4 5-30			Library File	12-5
	frequency domain	5-5 5-6			Line	6-10
	Frequency drift	6-13			Line Trigger	6-10
	Frequency Measurement	13-4			Linear Scale	2-10
	Frequency range	5-4			Load Corr Set	2-17
frequency span to 0	5-26	Load/Save Def Files	12-6			
Full Size	11-6	Location	11-6			
Full Span	2-8	log scale	2-10			
G)	Gate Control Signal	6-17	M)	MA1621A	2-16	
	gate cursor	6-19		Magnify 1 × 1	11-5	
	Gate Delay	6-17 6-19		Main Trace	5-9 5-11 5-14	
	Gate End Int Ext	6-18		Manual	3-11 7-7	
	Gate Length	6-19		Manual setting	7-5 7-9	
	Gate Setup	6-18		marked by an asterisk	1-6	
	Gate Sweep On Off	6-18		marker	3-3	
	Gate Trig Source	6-18		MARKER FUNCTIONS	3-3	
	GP-GL	11-6		Marker Level Abs Rel	3-10	
	GPIB interface	11-3		Marker List	3-12	
	GPIB My Address	11-7		Marker Mode	3-7	
	Green	9-8		Marker Off	3-9	
	H)	Harmonics		3-12	Marker Search	3-9 3-16
Highest 10		3-11	Marker Search Peak	3-9		
HP-GL, GP-GL		11-6	Marker Tracking	6-13		
HP2225		11-5	Marker Values	3-22		

Keyword	Page	Keyword	Page
Mask	13-6	Normalize (A-B+DL) On	5-7
MASK Creation Screen	13-36	O) observation of harmonic waves	3-24
Max Hold	5-15	Occ BW Measure	13-5 13-18
Measure	1-8 13-3	Occupied Frequency Bandwidth	13-18
measure envelope	5-24	off with Auto Select	3-14
Measuring Noise Power	13-4	Offsetting	2-14
Measuring Occupied Bandwidth	13-5	Outline	2-17 10-7 10-8
Media	2-17	Overwrite	5-8 5-16 5-17
Mem Card	10-10	P) page learning function	1-8
Memory Card	10-7	Paper Feed	11-4
Memory Directory	10-6	Paper Size	11-6
Menu On/Off	1-5	Parameter Display	9-6
Middle	5-7	Parameter except RFL	10-9
mistake	1-3	Pass/Fail Judgment by Mask	13-6
mixer level	7-9	PDC	13-20 13-28
Mkr→CF	3-23	Peak→CF	4-5
Mkr→CF Step Size	3-24	Peak→RLV	4-5
Mkr→RLV	3-23	Peak search	3-16
monitor function	11-12	Peak Signal	4-4
More key	1-6	PHS	13-12 13-14 13-25
Move	5-6	Plot Rocation Reset	11-4
Move Mask	13-6	Plotter	11-4
Move Template	13-7	Plotter Address	11-6
Moving the Measurement Point	4-5	Plotter Setup	11-4
Moving the Trace	5-6	Pos Peak	5-22 5-23 5-24
MS-DOS format	10-10	Post-trigger	6-11
Multi Marker	3-11 3-14	Power Measurement	13-11 13-15
Multimarker Off	3-15	Power On State	9-10
N) N% of Power	13-5	Pre-trigger	6-11
Narrow FM	11-12	Preset	1-3
Neg Peak	5-22 5-23 5-24	Printer	11-4
Next Dip Search	3-20	Printer Address	11-5
Next Left Peak	3-18	Printer Setup	11-4
Next Peak	3-17	Prog List	12-4
Next Right Peak	3-18	Protection	10-11
Noise Measure	13-4 13-10	PTA	12-3
Non-Stop	5-18	PTA Library	12-5
Normal	5-15 5-17 5-22	PTA Program	12-4
	5-23 5-24	PTL language	12-3
Normal Marker	3-7		

APPENDIX B KEYWORDS INDEX

	Keyword	Page	Keyword	Page
Q)	Quarter Size	11-6	Select Item	9-8
R)	Range 2kHz/Div	5-30	Select Marker No	3-14
	RB, VB, SWT Auto	7-4	Select Mask Table	13-6
	RBW	7-4	Select Media	10-10
	Recall	10-7	Select Source	12-7
	Recall Item	10-7 10-9	Select Temp Table	13-7
	Recall Media	10-7	Selecting a Plotter	11-4
	Recalling From Memory	10-7	Selecting a Printer	11-4
	Red	9-8	Set Date	9-11
	Ref	10-9	Set source into Dest	12-7
	Ref Level Offset	2-15	Set Time	9-11
	Ref Level Step Size	2-13	Setting Interface	11-7
	Ref Line	5-7	Setting Parameters	3-22
	reference marker	3-8	Setting Reference Level	2-12
	Rel	3-10 3-12	Setting Time Domain	5-26
	Relative Value	3-12	Setup	13-5
	Remove	12-5	Setup Corr	2-17 8-8
	resolution	3-20	SIGNAL SEARCH FUNCTION	4-3
	resolution dB	3-20	Signal Tracking	6-13
	Restart	5-10 5-17 6-18	Single	6-3
	RS-232C interface	11-3	Single Sweep Mode	6-4
	RS232C Setup	11-7	small display	5-9
	Run	12-4	SOUND	11-12
S)	S/N	5-19	Sound Monitor	11-13
	S/N improvement	5-20	Source	12-7
	Sample	5-22 5-23 5-24	Span	2-3
	sample point	5-24	Spot	3-4
	Save	10-5	spot marker	3-5
	Save Corr Set	2-17	Spurious Radiation Strength	13-22
	Save to Mem Card	10-5	Start	2-3
	Saving to Memory	10-5	Start freq	2-5
	Scroll→	2-6	Start Point	13-7
	Scroll Step Size	2-6	Step	2-4
	scrolled and selected	3-14	Step Size	2-4
	Search	3-21 4-3	Stop	2-5 5-10 5-17 6-18
	Search Above Below	3-21	Stop Continue	5-18
	Search Resolution	3-20	Stop freq	2-5
	Select Corr	2-17 8-8	Stop Non-Stop	5-18
	Select Dest	12-7	Stop Point	13-7
			Stop Print	11-4

Keyword	Page	Keyword	Page
Storage Mode	5-15 5-17	U) UNCAL	7-6
Storage	5-12 5-17 5-18	Unit	2-11
Sub Trace	5-11 5-14	User Color	9-7
Sub Trace Write View	5-10	User-Definition Operation	12-8
subtracts	5-7	V) V	2-9 2-11
Sweep Mode	6-3	VB/RB Ratio	7-7
Sweep Time	7-4	VBW	7-7
Swp Contl	5-10	Video	6-7
system	9-4	video filter	5-20
system parameter	9-3	Video Trigger	6-7
SYSTEM SETTING	9-3	View	5-16 5-17
system variable	12-4	Volume	11-12
T) threshold	3-21	VP-800	11-5
Time Gate Function	6-14	W) W	2-9 2-11
Time Span	5-12 5-27	Wide FM	11-12
Time Template	13-7 13-31	Wide IF Video	6-8 13-23
Title	11-11	Wide IF Video Trigger	6-8 6-14
title edit screen	12-9	write protect	10-11
Top	5-7	X) XdBDown mode	13-5
Tr-Time	5-12	Y) Yes No	12-4
Trace A	5-5 6-18	Z) Zero Span	2-8 5-26
Trace A on B	5-8	Zone Marker	3-4
Trace B	5-6	zone marker	3-26 5-28
Trace Calc	5-7	zone marker width	3-5 3-26
Trace Computation	5-7	Zone→Span	3-26
trace memories	5-24	Zone Span Point	5-28
Trace move	5-6	Zone Start Point	5-28
Trace Time	5-4 5-12 6-18	Zone Sweep	6-12
Tracking	6-13	Zone Width	3-4
Trig Level	6-8		
Trig Slope	6-8		
Trigger Freerun	5-12		
trigger level	6-8 6-11 6-17		
Trigger Mode	6-5		
Trigger Source	5-12		
trigger source	6-6		
Trigger/Gate	6-7		
Triggered	6-6		
Tune	4-4		
Type-1	9-6		

APPENDIX B KEYWORDS INDEX



## Head office address was changed

Head office address on the back cover was changed. Please substitute it as the following address.

**Anritsu Corporation**

1800 Onna, Atsugi-shi, Kanagawa, 243-8555, Japan

TEL: +81-46-223-1111



# Anritsu Service and Sales offices



## • Argentina

### MULTIRADIO S.A.

Av. Cordoba, 4860 Buenos Aires,  
C1414BAT, Argentina  
TEL: +55-4779-5522  
FAX: +55-4779-5510

## • Brazil

### ANRITSU ELETRÔNICA LTDA.

Praca Amadeu Amaral, 27-1 andar  
01327-010-Paraiso, Sao Paulo, Brazil  
TEL: +55-11-3283-2511  
FAX: +55-11-2886940

### ANRITSU ELETRÔNICA LTDA.

Praia de Botafogo, 440-24 andar-Botafogo  
22250-040, Rio de Janeiro, RJ, Brazil  
TEL: +55-21-2527-6922  
FAX: +55-11-2537-1456

## • Canada

### ANRITSU ELECTRONICS LTD.

#### (HEADQUARTERS IN OTTAWA OFFICE)

700 Silver Seven Road, Suite 120, Kanata,  
Ontario K2V 1C3, Canada  
Toll free: 1-800-ANRITSU (267-4878)  
TEL: +1-613-591-2003  
FAX: +1-613-591-1006

### ANRITSU ELECTRONICS LTD.

#### (VANCOUVER OFFICE)

300-1055 W Hastings St., Vancouver, BC  
V6E 2E9, Canada  
Toll free: +1-877-267-4878  
TEL: +1-604-682-5933  
FAX: +1-604-682-5934

### ANRITSU ELECTRONICS LTD.

#### (TORONTO OFFICE)

2810 Matheson Blvd. E, 2nd Fl.,  
Mississauga, ON L4W 4X7, Canada  
Toll free: +1-877-267-4878  
TEL: +1-905-890-7799  
FAX: +1-905-625-5864

## • Chile

### SISTEMAS DE INSTRUMENTACION LTDA.

Concha y Toro 65, Stgo Centro  
Santiago, Chile 51880  
TEL: +56-2-6960031  
FAX: +56-2-6969665

## • Colombia

### RENTAMETRIC LTDA.

Calle 24 No. 32-67, Apartado: 23030  
Santafe de Bogota, D.C. Colombia  
TEL: +57-1-269-6555  
FAX: +57-1-269-0191

## • Costa Rica

### SONIVISION, S.A.

P.O. Box 620-1000, San Jose, Costa Rica  
TEL: +506-231-5685  
FAX: +506-231-6531

## • Ecuador

### EQUITRONICS S.A.

Belgica N-32 Hy Av. De Los Shyris,  
Edificio IVSEMON PARK, Suite 4B, Quito,  
Ecuador  
TEL: +593-2-255-396  
FAX: +593-2-255-396

## • El Salvador

### EMPRESA DE COMERCIO EXTERIOR S.A. DE C.V.

Centro Comercial Feria Rosa, Alameda  
Dr. Manuel Enrique Araujo, Edificio H,  
Local 315 San Salvador, El Salvador  
TEL: +503-243-3924  
FAX: +503-243-3925

## • Guatemala

### IMPELSA.

4a Calle 1-15 Zong 10 Guatemala, C.A.  
01010, Guatemala  
TEL: +502-360-5135  
FAX: +502-360-5217

## • Mexico

### SIHIKATRONICS mmWAVE S.A. DE C.V.

Luz Saviñon 9-701, Col. Del Valle, C.P.  
03100, Mexico, D.F., Mexico  
TEL: +52-5-5437313  
FAX: +52-5-5437317

## • Paraguay

### DATALAB S.R.L.

Avda. Artigas No 1645 Edificio "DataLab"  
Asuncion, Paraguay  
TEL: +595-21-20-9126  
FAX: +595-21-20-9127

## • Peru

### ELETELSE S.A.

AV Canaval Moreyra 748, San Isidro,  
Lima 27, Peru  
TEL: +51-1-224-2514  
FAX: +51-1-224-8148

## • U.S.A.

### ANRITSU COMPANY

1155 East Collins Blvd., Richardson, TX  
75081, U.S.A.  
Toll Free: +1-800-ANRITSU (267-4878)  
TEL: +1-972-644-1777  
FAX: +1-972-644-3416

### ANRITSU COMPANY

490 Jarvis Drive, Morgan Hill, CA 95037,  
U.S.A.  
Toll Free: +1-800-ANRITSU (267-4878)  
TEL: +1-408-778-2000  
FAX: +1-408-778-3180

### ANRITSU COMPANY

10 New Maple Ave., Unit 305,

P.O. Box 836, Pine Brook, NJ 07058-0836  
U.S.A.

Toll Free: +1-800-ANRITSU (267-4878)

TEL: +1-973-227-8999

FAX: +1-973-575-0092

### ANRITSU COMPANY

#### SALES AND SERVICE, FL OFFICE

312 W. First Street, Suite 300, Sanford,  
FL 32771, U.S.A.

Toll Free: 1-800-ANRITSU (267-4878)

TEL: +1-407-321-5130

FAX: +1-407-330-2018

### ANRITSU COMPANY

#### SALES AND SERVICE, GA OFFICE

4625 Alexander Drive, Alpharetta,  
GA 30022, U.S.A.

Toll Free: 1-800-ANRITSU (267-4878)

TEL: +1-678-566-0454

FAX: +1-678-566-1776

## • Uruguay

### CABONORTE S.A.

Colonia 1900, Esc. 603, Montevideo,  
Uruguay  
TEL: +598-2-430522  
FAX: +598-2-418594

## • Venezuela

### RADIOCOMUNICACIONES CRUZ, C.A.

Calle La Colina Quinta. Ellison, Frente al  
teatro Alberto Mateo Caracas 1050,  
Venezuela  
TEL: +58-2-793-2322  
FAX: +58-2-793-3429



## • Austria

### WIEN-SCHALL GmbH

Krichbaumgasse 25, A-1120 Vienna,  
Austria  
TEL: +43-1-81155140  
FAX: +43-1-81155180

## • Belgium

### ANRITSU GmbH

Grafenberger Allee 54-56, 40237  
Düsseldorf, Germany  
Local phone: 0800-90001 (toll free)  
TEL: +49-211-96855-0  
FAX: +49-211-96855-55

## • Bulgaria

### ELSINCO Representation OFFICE Sofia

h.e. Strelbishte, str. Kotelnski Prohod,  
bl. 96/6/14, BG-1408 Sofia, Bulgaria  
TEL: +359-2-958-1245  
FAX: +359-2-958-1698

• Croatia

**ELSINCO REPRESENTATION OFFICE  
ZAGREB**

Savska 66 HR-10000 Zagreb, Croatia  
TEL: +385-1-6312-477  
FAX: +385-1-6312-488

• Czech Republic

**ELSINCO PRAHA SPOL S.R.O.**

Novodvorská 994, CZ-142 21 Praha,  
4-Branik, Czech Republic  
TEL: +420-2-4149-0147  
FAX: +420-2-4447-2169

**ELSINCO PRAHA SPOL S.R.O.  
(BRNO BRANCH OFFICE)**

Strmá 19, CZ-616 00 Brno, Czech  
Republic  
TEL: +420-5-4142-7211  
FAX: +420-5-4142-7219

• Denmark

**INSTRUMENTS A/S**

Lokesalle 30, DK-8700 Horsens, Denmark  
TEL: + 45 75646500  
FAX: + 45 75643700

• Finland

**ANRITSU AB**

**(FINLAND BRANCH OFFICE)**

Piispanportti 9, FIN-02240 Espoo, Finland  
TEL: +358-9-435-522-0  
FAX: +358-9-435-522-50

• France

**ANRITSU S.A.**

9 Avenue du Québec, ZA Courtabœuf 1  
91951 LES ULIS CEDEX, France  
TEL: +33 1 60 92 15 50  
FAX: +33 1 64 46 10 65

**ANRITSU S.A.**

**(TOULOUSE OFFICE)**

Bureau de Toulouse Région Centre Sud  
Ouest, France  
TEL: +33-5-62070484  
FAX: +33-5-62070668

**ANRITSU S.A.**

**(TOULON OFFICE)**

Bureau de Toulon Région Centre Sud Est,  
France  
TEL: +33-4-94040264  
FAX: +33-4-94040265

**ANRITSU S.A.**

**(RENNES OFFICE)**

Bureau de Rennes Région Ouest, France  
TEL: +33-2-99521214  
FAX: +33-2-99521224

• Germany

**ANRITSU GmbH**

Grafenberger Allee 54-56, 40237  
Düsseldorf, Germany  
TEL: +49-211-96855-0  
FAX: +49-211-96855-55

• Greece

**KOSTAS KARAYANNIS SA**

58 Kapodistriou str, GR-142 35 Nea Ionia,  
Athens, Greece  
TEL: +30-1-680-0460-4  
FAX: +30-1-685-3522

• Hungary

**ELSINCO BUDAPEST KFT**

Pannónia útca 8. IV/l., H-1136 Budapest,  
Hungary  
TEL: +36-1-339-0000  
FAX: +36-1-339-4444

• Ireland

**PEMA LTD.**

Dromiskin, Dundalk, Co. Louth, Ireland  
TEL: +353-42-72899  
FAX: +353-42-72376

• Italy

**ANRITSU S.P.A.**

Via Elio Vittorini 129, 00144 Roma, Italy  
TEL: +39-06-509-9711  
FAX: +39-06-502-2425

**ANRITSU S.P.A.**

Via Paracelso 4, CD Colleoni, Agrate  
Brianza, 20041 Milano, Italy  
TEL: +39-039-657021  
FAX: +39-039-6056396

• Norway

**BLOMKVIST AS**

Pb 188, 1371 ASKER, Norway  
TEL: + 47 66901190  
FAX: + 47 66901212

• Poland

**ELSINCO POLSKA SP. Z.O.O**

ul Gdanska 50, 01-691 Warszawa, Poland  
TEL: +48-22-39-832-4042 (Sat Link)  
FAX: +48-22-832-2238

• Portugal

**OMNITECNICA S.A.**

Estrada de Alfragide 23, 2720-015  
Amadora, Portugal  
TEL: +351-21-472-12-00  
FAX: +351-21-472-12-70 (Sales)

• Slovakia

**ELSINCO SLOVENSKO S.R.O**

Kudláková 4, SK-844 15 Bratislava,  
Slovakia  
TEL: +421 7 6428 41 65  
FAX: +421 7 6428 44 54

**ELSINCO SLOVENSKO S.R.O**

**(KOŠICE BRANCH OFFICE)**

Floriánska 16, SK-043 13 Kosice, Slovakia  
TEL: +421 95 62 26 729  
FAX: +421 95 62 26 729  
CONTACT: Mr. Igor Domorak,  
Branch Office Manager

• Slovenia

**ELSINCO D.O.O.**

Dalmatinova 2, SI-1000 Ljubljana,  
Slovenia  
TEL: +386-61-133-62-77  
FAX: +386-61-317-397

• Sweden

**ANRITSU AB**

Botvid Center, Fittja Backe 1-3 S-145  
84, Stockholm, Sweden  
TEL: +46-8-534-70700  
FAX: +46-8-534-70730

• United Kingdom

**ANRITSU LTD.**

200 Capability Green, Luton, Bedfordshire,  
LU1 3LU, U.K.  
TEL: (Sales) + 44 1582-433280  
(Service) +44 1582-433285  
FAX: +44 1582-731303



• Australia

**ANRITSU PTY LTD.**

Unit 3/170 Forster Road, Mount. Waverley,  
Vic., 3149, Australia  
TEL: +61-3-9558-8177  
FAX: +61-3-9558-8255

• Bahrain

**BASMATECH**

P. O. Box 5701, Manama, Bahrain  
TEL: +973-273729  
FAX: +973-725404

• China

**ANRITSU COMPANY LTD.**

Suite 923, 9/F., Chinachem Golden Plaza  
77 Mody Road, Tsimshatsui East,  
Kowloon, Hong Kong  
TEL: +852-2301-4980  
FAX: +852-2301-3545

**ANRITSU COMPANY LTD.**

**(BEIJING REPRESENTATIVE OFFICE)**

Room 1515, Beijing Fortune Building  
No. 5 North Road, the East 3rd Ring Road,  
Chao-Yang District, Beijing 100004  
P.R. China  
TEL: +86-10-6590-9230  
FAX: +86-10-6590-9235

**ANRITSU COMPANY LTD.**

**(SHANGHAI OFFICE)**

Room 1807-1810, Tower A CITY CENTER  
of Shanghai  
No. 100 ZunYi Road 200051 P.R.China  
TEL: +86-021-6237-0898  
FAX: +86-021-6237-0899

**ANRITSU COMPANY LTD.  
(GUANGZHOU REPRESENTATIVE  
OFFICE)**

Room 3008-9, Dongshan Plaza, 69 Xian  
Lie Zong Road Central, Guangzhou  
510095, P.R. China  
TEL: +86-20-8732 2231/2  
FAX: +86-20-8732 2230

**ANRITSU COMPANY LTD.  
(CHENGDU REPRESENTATIVE OFFICE)**

26E New Times Square, No. 42, Wenwu  
Road, Xinhua Street, Chengdu 610017  
P.R. China  
TEL: +86-28-8651 0011/22/33  
FAX: +86-28-8651 0055

**ANRITSU COMPANY LTD.  
(XI'AN REPRESENTATIVE OFFICE)**

No.1102, ZhiCheng Building, No.2  
Gao Xin I Road, High-Tech, Development  
Zone, Xi'an 710075, P.R. China  
TEL: +86-29-8377 406/9  
FAX: +86-29-8377 410

**ANRITSU COMPANY LTD.  
(SHENZHEN REPRESENTATIVE  
OFFICE)**

Room 1505, Building A  
World Trade Plaza, Fuhong Road  
Shenzhen 518033, P.R. China  
TEL: +86-755-8366 2847/2851/2852  
FAX: +86-755-8366 2849

**ANRITSU COMPANY LTD.  
(CHONG QING REPRESENTATIVE  
OFFICE)**

Room 6-2, D Building, Kejifazhan Plaza  
No.210, Keyuan 1st Road, Gaoxin District  
ShiqiaoPu, Chongqing 400010  
P.R. China  
TEL: +86-23-8909-9918  
FAX: +86-23-8909-9928

**ANRITSU ELECTRONICS (SHANGHAI)  
CO., LTD. (SERVICE CENTER)**

2F, Room B, 52 Section Factory Building  
No. 516 Fu Te North Road  
Waigaoqiao Free Trade Zone  
Pudong, Shanghai 200131, P.R. China  
TEL: +86-21-5868-0226/7/8  
FAX: +86-21-5868-0588

**ANRITSU COMPANY LTD.  
(SHENYANG REPRESENTATIVE  
OFFICE)**

2-185, City Plaza, No. 206, Nanjing North  
Street, He Ping District, Shenyang 110001  
P.R. China  
TEL: +86-24-2334 1178/89  
FAX: +86-24-2334 2838

**ANRITSU COMPANY LTD.  
(WUHAN REPRESENTATIVE OFFICE)**

A1803, ZhongShang Plaza  
No. 7, Zhongnan Road  
Wuchang, Wuhan 430071, P.R. China  
TEL: +86-27-8771 3355  
FAX: +86-27-8732 2773

**• Cyprus**

**CHRIS RADIOVISION LTD.**  
23 Crete Street, T.T. 1061  
P. O. Box 21989, 1515Nicosia, Cyprus  
TEL: +357-2-766121  
FAX: +357-2-765177

**• Egypt**

**GIZA SYSTEMS ENGINEERING S.A.E**  
17 Teeba Street Mohandeseen P.O. Box  
317 Dokki-Cairo 12311, Egypt  
TEL: +20-2-3368095  
FAX: +20-2-3385799

**• Indonesia**

**PT. SUBUR SAKTI PUTERA**  
Graha Astri Aniela Angun, Jl. Tanah  
Abang III/15, Jakarta 10160, Indonesia  
TEL: +62-21-352-4828  
FAX: +62-21-352-4831

**• Israel**

**TECH-CENT LTD.**  
P. O. Box 43259 (Mailing Address),  
Tel-Aviv 61430 Israel, Street Address:  
Raul Valenberg 4 Ramat Haahayal, Tel-  
Aviv 69710, Israel  
TEL: +972-36-478563  
FAX: +972-36-478334

**• Korea**

**ANRITSU CORPORATION, LTD.**  
8F HyunJuk Building, 832-41  
Yeoksam-Dong, Kangnam-Ku, Seoul 135-  
080  
Korea  
TEL: +82-2-553-6603  
FAX: +82-2-553-6604

**ANRITSU CORPORATION, LTD.**

Room 1503, Dong-A Venture Tower 538-8  
BongMyung-Dong, Yusong-Gu  
Daejeon, 305-301  
Korea  
TEL: +82-42- 828-7783  
FAX: +82-2-42-828-7785

**• Kuwait**

**TAREQ COMPANY**  
P.O. Box 20506 Safat, 13066 Safat,  
Kuwait  
TEL: +965-431-0615  
FAX: +965-431-4085

**• Malaysia**

**O'CONNOR'S ENGINEERING SDN BHD**  
3rd Floor Bangnan O'Connor, 13 Jalan  
223, 46100 Petaling Jaya,  
Selangor Darul Ehsan, Malaysia  
TEL: +60-3-753-8400  
FAX: +60-30-757-7871

**• Morocco**

**SEDEL**  
24, 26, Bd, Resistance, Casablanca,  
Morocco

TEL: +212-2-302444  
FAX: +212-2-449311

**• Nepal**

**BR INTERNATIONAL PVT. LTD.**  
P. O. Box 60, Tamrakar Comm. Bldg.,  
Bhotabahal Kathmandu, Nepal  
TEL: +977-1-224-706  
FAX: +977-1-227-956

**• New Zealand**

**NILSEN TECHNOLOGIES  
(AUCKLAND OFFICE)**  
P. O. Box 9613, New market Unit 4,  
Ambury Court, 1 Porters Ave, Eden  
Terrace Auckland, New Zealand  
TEL: +64-9-309-2464  
FAX: +64-9-309-2968

**NILSEN TECHNOLOGIES  
(WELLINGTON OFFICE)**

35 Ulric Street, Plimmerton Wellington,  
New Zealand  
TEL: +64-4-233-9116  
FAX: +64-4-233-8366

**• Oman**

**NATIONAL PROJECTS AND  
TECHNOLOGY COMPANY L.L.C**  
P. O. Box 97, Wadi Al Kabir, Postal Code  
117, Sultanate of Oman  
TEL: +968-793741  
FAX: +968-796158

**• Pakistan**

**AETCO**  
Zia Chambers, 25-Mcleod road, Lahore  
54000, Pakistan  
TEL: +92-42-7221716, 7311035  
FAX: +92-42-7221456

**SUPERIOR ELECTRONICS  
ASSOCIATED**

B-98 Block H, North Nasimabad,  
Karachi-33, Pakistan  
TEL: +92-21-613655

**• Philippines**

**SALRITSU INTERNATIONAL TRADING  
CORPORATION**  
5QB ODC-International Plaza  
Condominium, 219 Salcedo St., Legaspi  
Village, Makati City 1229, Philippines  
TEL: +632-816-2646, 893-8998  
FAX: +632-815-0986

**• Puerto Rico**

**CARIBBEAN DATA SYSTEM**  
636, San Patricio Ave. San Juan,  
PR00920-4507, Puerto Rico  
TEL: +1-787-774-6969  
FAX: +1-787-774-6973

• Qatar

**QATAR COMMUNICATIONS LTD.**  
P. O. Box 2481, Doha Qatar  
TEL: +974-4-424347  
FAX: +974-4-324777

• Saudi Arabia

**A. RAJAB & A. SILSILAH & CO.**  
P. O. Box 203, Jeddah 21411, Saudi Arabia  
TEL: +966-2-6610006  
FAX: +966-2-6610558

**ELECTRONIC EQUIPMENT  
MARKETING CO.**

P. O. Box 3750, Riyadh, 11481,  
Saudi Arabia  
TEL: +966-3-887-0218  
FAX: +966-3-887-0268

• Singapore

**ANRITSU PTE. LTD.**  
10, Hoe Chiang Road #07-01/02, Keppel  
Towers, Singapore 089315  
TEL: +65-6282-2400  
FAX: +65-6282-2533

• South Africa

**ETECSA (PTY) LTD.**  
12 Surrey Square Office Park, 330 Surrey  
Avenue, Ferndale, 2194 Randburg,  
South Africa (P. O. Box 4231 Randburg,  
2125 South Africa)  
TEL: +27-11-787-7200  
FAX: +27-11-787-0446

• Sri Lanka

**INFOTECHS LIMITED**  
441, Alwittigala Mawatha, Colombo,  
Sri Lanka  
TEL: +94-1-598237  
FAX: +94-1-598112

• Taiwan

**ANRITSU COMPANY, INC.**  
(TAIPEI OFFICE)  
7F, No. 316, Sec. 1, NeiHu Rd., Taipei,  
Taiwan  
Phone: +886-2-8751-1816  
Fax: +886-2-8751-1817

**ANRITSU COMPANY, INC.**  
(HSINCHU OFFICE)  
11F-3, 270, Sec. 1, Kuang-Fu Rd.,  
Hsinchu, Taiwan  
TEL: +886-3-563-6601, 6602, 6603  
FAX: +886-3-564-5819

• Thailand

**JASMINE TELECOM SYSTEMS CO.,  
LTD.**  
200 Moo 4, 9th Floor, Chaengwatana  
Road, Tambon Pakkret, Amphoe Pakkret,  
Nonthaburi 11120, Thailand  
TEL: +66-2-502-3240, 3000  
FAX: +66-2-962-2521

• Turkey

**INTER-INTRADE BILGISAYAR  
ELEKTRONIK SAN. TIC. A.S.**  
Egitim Mah. Poyraz Sok., Sadikoglu Is  
Merkezi 1, No: 11, Kadikoy Istanbul,  
Turkey  
TEL: +90-216-4144758  
FAX: +90-216-4144762

**TEST**

Sehit Adem Yavuz Sokak No. 14/15  
06640, Kizilay-Ankara, Turkey  
TEL: +90-312-419-3688  
FAX: +90-312-419-4099

• United Arab Emirates

**UTMOST ELECTRONICS TRADING  
L.L.C.**  
(ABU DHABI BRANCH)  
P. O. Box: 41175, Abu Dhabi,  
United Arab Emirates  
TEL: +971-2-6458909  
FAX: +971-2-6458907

• Vietnam

**SYSTEM & TECHNOLOGIES VIETNAM  
LTD.**  
Unit # B236, Binh Minh Hotel 27 Ly Thai  
To Str Hanoi, Vietnam  
TEL: +84-48.264.728  
FAX: +84-49.344.111

• Zimbabwe

**MARTWELL ELECTRONICS (PVT) LTD.**  
P.O. Box CH 857 Chisipite Harare,  
Zimbabwe  
TEL: +263-4-494928  
FAX: +263-4-494927

**Japan**

<http://www.anritsu.co.jp/E/>

• Japan

**ANRITSU CORPORATION**  
1800 Onna, Atsugi-shi, Kanagawa,  
243-8555, Japan  
TEL: +81-46-223-1111  
FAX: +81-46-296-1264